

C-XXXXX-DFB2.5-XX-SXXXI/XXX-X-XX

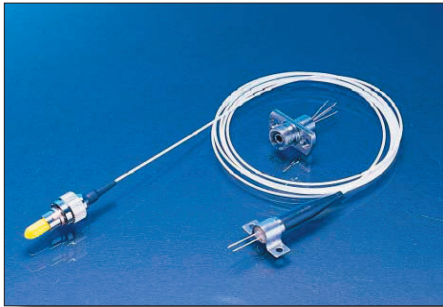

### Features

- Un-cooled laser diode with MQW structure
- High temperature operation without active cooling
- Hermetically sealed active component
- Built-in InGaAs monitor photodiode
- Complies with Telcordia Technologies GR-468-CORE
- Single frequency operation with high SMSR
- TOSA
- FC/ST/SC receptacle package with 2-hole flange
- Fiber pigtailed with optional FC/ST/SC/MU/LC connector
- Design for 2.5G CWDM high speed optic networks
- RoHS Compliant available

### Absolute Maximum Ratings

Parameter	Symbol	Rating	Unit
Fiber Output Power L/M/H/2	$P_f$	0.6(L)/1(M)/2(H)/2.6(2)	mW
LD Reverse Voltage	$V_{RLD}$	2	V
PD Reverse Voltage	$V_{RPD}$	10	V
PD Forward Current	$I_{FPD}$	2.0	mA
Operating Temperature	$T_{opr}$	0 ~ 70	°C
Storage Temperature	$T_{stg}$	-40 ~ 85	°C

(All optical data refer to a coupled 9/125 $\mu$ m S/M fiber)

### Optical and Electrical Characteristics (Tc=25°C)

Parameter	Symbol	Min	Typ	Max	Unit	Test Conditions	
Threshold Current	$I_{th}$	-	-	20	mA	CW	
Fiber Output Power	$P_f$	L	0.2	-	0.5	mW	CW, $I_{th}+25$ mA, kink free
		M	0.5	-	1.0		
		H	1.0	1.6	-		CW, $I_{th}+30$ mA, kink free
		2	2.0	2.5	-		
Peak Wavelength	$\lambda$	n-2	n	n+2	nm	Note 3	
		n-3	n	n+3			
Side mode Suppression	$S_r$	30	35	-	dB	CW, $P_f = P_f$ (Min), 0~70°C	
Forward Voltage	$V_f$	-	1.2	1.5	V	CW, $P_f = P_f$ (Min)	
Rise Time	$t_r$	-	-	150	ps	$I_{bias} = I_{th}$ , 20~80% lead length=1mm	
Fall Time	$t_f$	-	-	200			
Tracking Error	$\Delta P_f / P_f$	-1.5	-	1.5	dB	APC, 0~70°C	
PD Monitor Current	$I_m$	100	-	-	$\mu$ A	CW, $P_f = P_f$ (Min), $V_{RPD}=2$ V	
PD Dark Current	$I_{dark}$	-	-	0.1	$\mu$ A	$V_{RPD}=5$ V	
PD Capacitance	$C_t$	-	6	15	pF	$V_{RPD}=5$ V, f=1MHz	
Optical Isolation	OI	30	-	-	dB	Tc=25°C	
		20	-	-		0°C < Tc < 70°C	

**Note: 1.Pin assignment can be customized.**

**2.Specifications subject to change without notice.**

**3.Selected wavelength is available for WDM application**

**\*Peak wavelength n=1270;1290;1310;1330;1350;1370;1390;1410;1430;1450;1470;1490;1510;1530;1550;1570;1590;1610**

C-XXXXX-DFB2.5-XX-SXXXX/XXX-X-XX

LD Pin Assignment

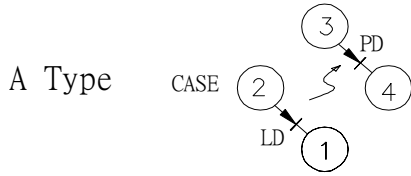

Pin 1 : Laser Cathode  
Pin 2 : Laser Anode and Case Gnd  
Pin 3 : Monitor Diode Anode  
Pin 4 : Monitor Diode Cathode

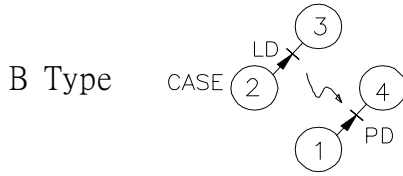

Pin 1 : Monitor Diode Anode  
Pin 2 : Laser Anode and Case Gnd  
Pin 3 : Laser Cathode  
Pin 4 : Monitor Diode Cathode



Pin 1 : Laser Anode and Monitor Diode Cathode  
Pin 2 : Case Gnd  
Pin 3 : Laser Cathode  
Pin 4 : Monitor Diode Anode

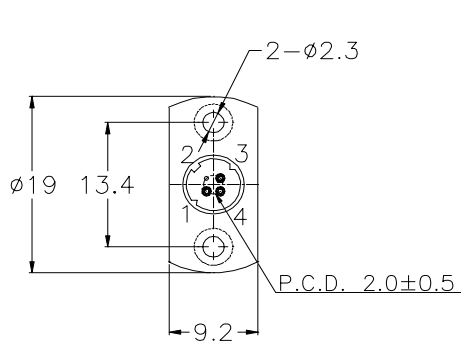

FC Receptacle

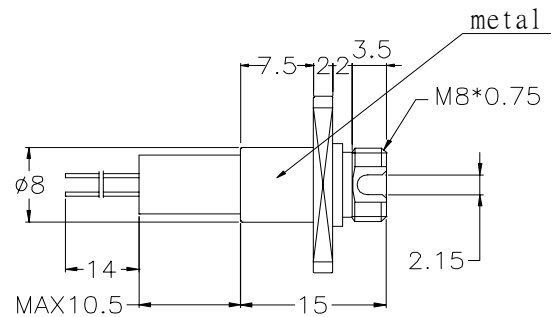

(2)#2-56 UNC02B Thread Thru

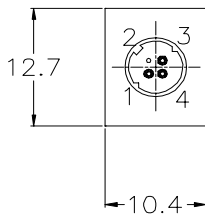

ST Receptacle

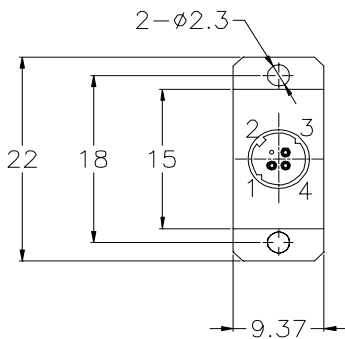
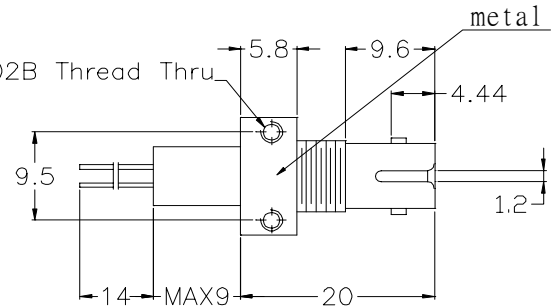

SC Receptacle

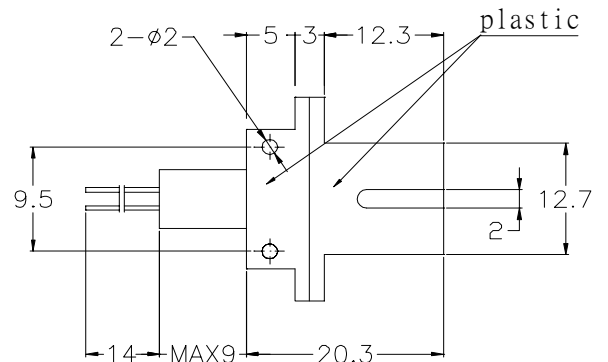

C-XXXXX-DFB2.5-XX-SXXXI/XXX-X-XX

Packaging Dimension

Units in mm.

Part Number: C-XXXXX-DFB2.5-TX-SXXXI

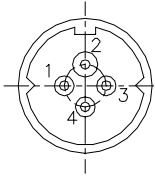

SC TOSA  
C-XXXXX-DFB2.5-TX-SSCXX

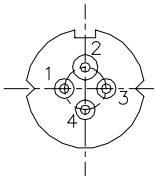
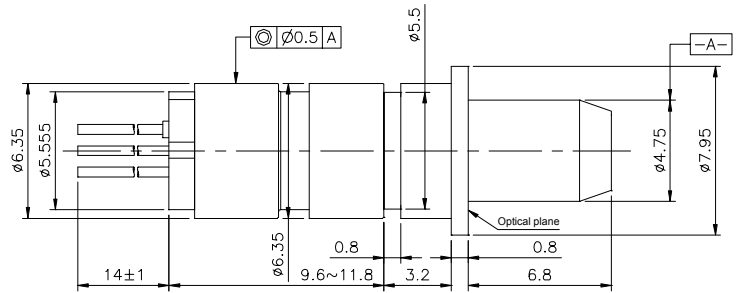

LC TOSA  
C-XXXXX-DFB2.5-TX-SLCXI

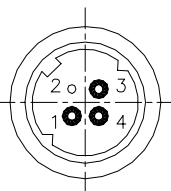
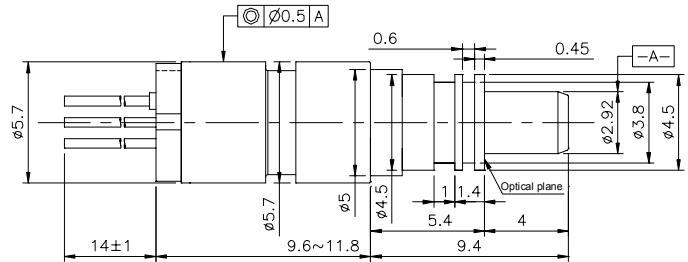

Customer Specified  
TOSA

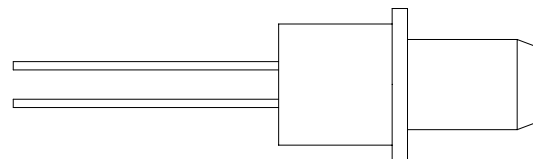

C-XXXXX-DFB2.5-XX-SXXXI/XXX-X-XX

Packaging Dimension

Units in mm.

Part Number: C-XXXXX-DFB2.5-PX-SXXXI/XXX-X-XX

P.C.D.  $2.0 \pm 0.5$

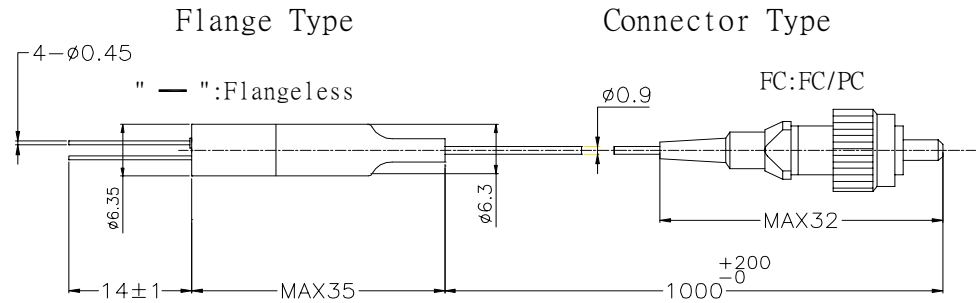
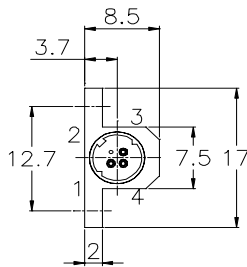
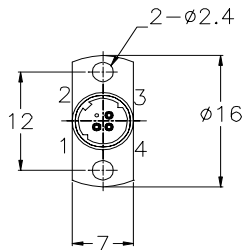
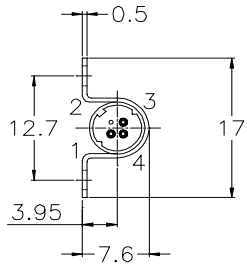

"□": Horizontal (Omega Housing)

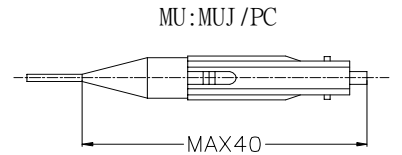
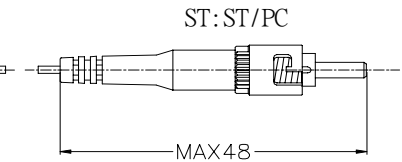
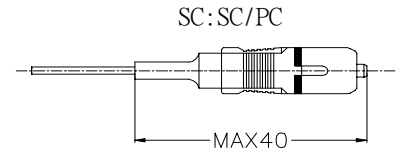
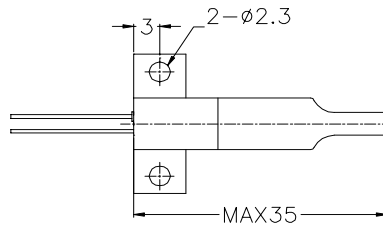

"V": Vertical

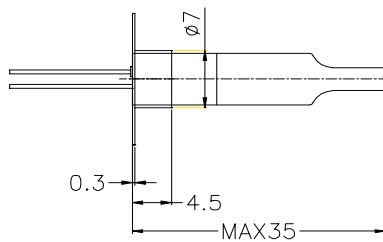

LC:LC/PC

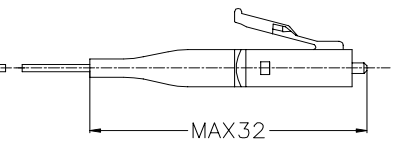

"K": Horizontal (KX Housing)

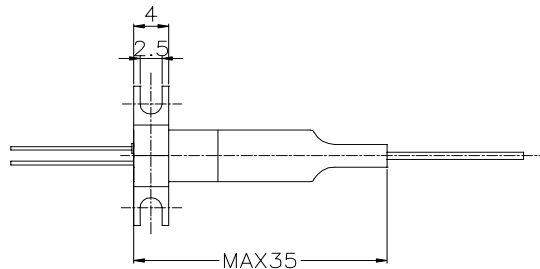

C-XXXXX-DFB2.5-XX-SXXXI/XXX-X-XX

## Ordering Information

# C-XXXXX-DFB2.5-XX-SXXXI/XXX-X-XX

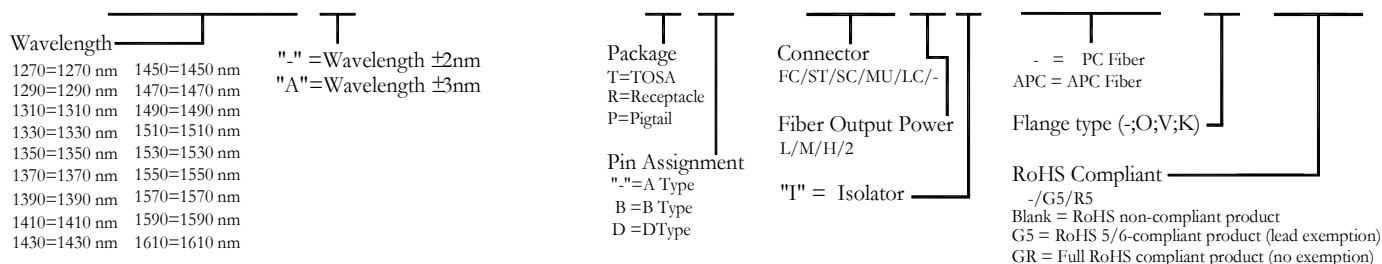

## Warnings

**Handling Precautions:** This device is susceptible to damage as a result of electrostatic discharge (ESD). A static free environment is highly recommended. Follow guidelines according to proper ESD procedures.

**Laser Safety:** Radiation emitted by laser devices can be dangerous to human eyes. Avoid eye exposure to direct or indirect radiation.

## Legal Notice

### IMPORTANT NOTICE!

All information contained in this document is subject to change without notice, at Luminent's sole and absolute discretion. Luminent warrants performance of its products to current specifications only in accordance with the company's standard one-year warranty; however, specifications designated as "preliminary" are given to describe components only, and Luminent expressly disclaims any and all warranties for said products, including express, implied, and statutory warranties, warranties of merchantability, fitness for a particular purpose, and non-infringement of proprietary rights. Please refer to the company's Terms and Conditions of Sale for further warranty information.

Luminent assumes no liability for applications assistance, customer product design, software performance, or infringement of patents, services, or intellectual property described herein. No license, either express or implied, is granted under any patent right, copyright, or intellectual property right, and Luminent makes no representations or warranties that the product(s) described herein are free from patent, copyright, or intellectual property rights. Products described in this document are NOT intended for use in implantation or other life support applications where malfunction may result in injury or death to persons. Luminent customers using or selling products for use in such applications do so at their own risk and agree to fully defend and indemnify Luminent for any damages resulting from such use or sale.

THE INFORMATION CONTAINED IN THIS DOCUMENT IS PROVIDED ON AN "AS IS" BASIS. Customer agrees that Luminent is not liable for any actual, consequential, exemplary, or other damages arising directly or indirectly from any use of the information contained in this document. Customer must contact Luminent to obtain the latest version of this publication to verify, before placing any order, that the information contained herein is current.

© Luminent, Inc. 2005  
 All rights reserved