

**Technical Data Sheet –Top View LED**

**67-21UBC/B040/TR8/AM**

**Features**

- Pb-free.
- Inner reflector.
- White package.
- Optical indicator.
- P-LCC-2 package.
- Wide viewing angle.
- Colorless clear resin.
- Precondition : Base on JEDEC Level-2.
- ESD : Up to 2KV. (Base JESD22-A114-B)
- The product itself will remain within RoHS compliant version.
- Suitable for vapor-phase reflow, infrared reflow and wave solder processes.



**Descriptions**

- The 67-21 series is available for orange, green, blue and yellow or other color due to the different raw material.
- Base on the package design, the device result in wide view angle.

**Applications**

- Automotive backlighting or indicator : Dashboard, switch, audio and video equipments...etc.
- Backlight : LCD, switches, symbol, mobile phone and illuminated advertising.
- Display for indoor and outdoor application : Traffic...etc.
- Ideal for coupling into light guides.
- Substitution of traditional light
- Optical indicator
- General applications.

**Device Selection Guide**

Chip		Resin Color
Material	Emitted Color	
InGaN/SiC	Blue	Water Clear

Technical Data Sheet –Top View LED

**67-21UBC/B040/TR8/AM**

Package Dimensions

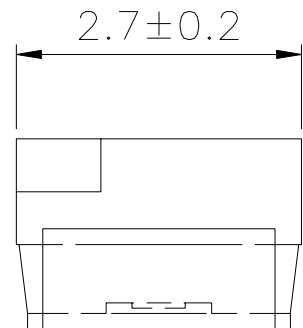
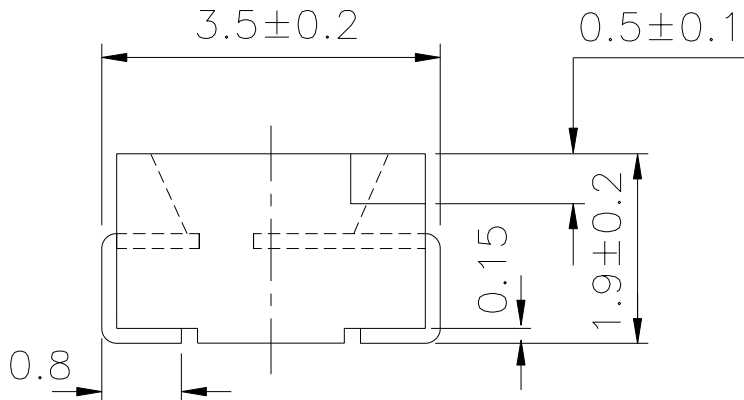
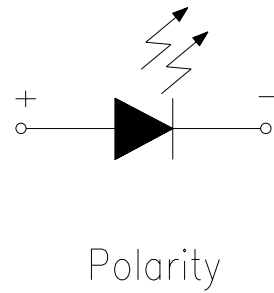
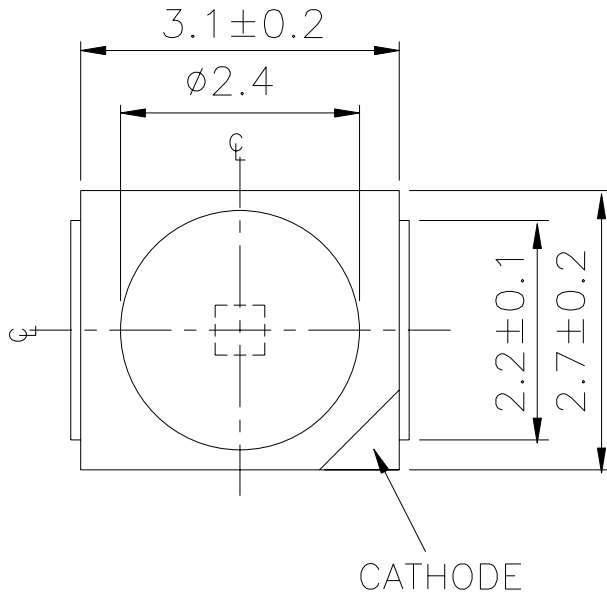

**Note :** Tolerances unless dimension ±0.1mm. Unit = mm

**Technical Data Sheet –Top View LED**

**67-21UBC/B040/TR8/AM**

**Absolute Maximum Ratings (Ta=25°C)**

Parameter	Symbol	Rating	Unit
Reverse Voltage	V <sub>R</sub>	5	V
Forward Current	I <sub>F</sub>	30	mA
Peak Forward Current (Duty 1/10 @1KHz)	I <sub>FP</sub>	100	mA
Power Dissipation	P <sub>d</sub>	150	mW
Junction Temperature	T <sub>j</sub>	125	°C
Operating Temperature	T <sub>opr</sub>	-40 ~ +100	°C
Storage Temperature	T <sub>stg</sub>	-40 ~ +110	°C
Soldering Temperature	T <sub>sol</sub>	Reflow Soldering : 260 °C for 10 sec. Hand Soldering : 350 °C for 3 sec.	

**Electro-Optical Characteristics (Ta=25°C)**

Parameter	Symbol	Min.	Typ.	Max.	Unit	Condition
Luminous Intensity	I <sub>v</sub>	6.3	-----	20	mcd	I <sub>F</sub> =10mA
Viewing Angle	2 θ 1/2	-----	120	-----	deg	I <sub>F</sub> =10mA
Peak Wavelength	λ <sub>p</sub>	-----	428	-----	nm	I <sub>F</sub> =10mA
Dominant Wavelength	λ <sub>d</sub>	463	-----	472	nm	I <sub>F</sub> =10mA
Spectrum Radiation Bandwidth	Δλ	-----	65	-----	nm	I <sub>F</sub> =10mA
Forward Voltage	V <sub>F</sub>	2..8	-----	4.2	V	I <sub>F</sub> =10mA
Reverse Current	I <sub>R</sub>	-----	-----	10	μ A	V <sub>R</sub> =5V

**Notes :**

- 1. Tolerance of Luminous Intensity : ±11%**
- 2. Tolerance of Dominant Wavelength ±1nm**
- 3. Tolerance of Forward Voltage ±0.1V**

**Technical Data Sheet –Top View LED**

**67-21UBC/B040/TR8/AM**

**Bin Range Of Dominant Wavelength**

Bin	Min	Max	Unit	Condition
1	463	466	nm	I <sub>F</sub> =10mA
2	466	469		
3	469	472		

**Bin Range of Luminous Intensity**

Bin Code	Min.	Max.	Unit	Condition
K1	6.3	7.8	nm	I <sub>F</sub> =10mA
K2	7.8	10.0		
L1	10.0	12.5		
L2	12.5	16.0		
M1	16.0	20.0		

**Bin Range of Forward Voltage**

Bin	Min	Max	Unit	Condition
01	2.8	3.0	V	I <sub>F</sub> =10mA
02	3.0	3.2		
03	3.2	3.4		
04	3.4	3.6		
05	3.6	3.8		
06	3.8	4.0		
07	4.0	4.2		

**Notes :**

- 1. Tolerance of Luminous Intensity : ±11%**
- 2. Tolerance of Dominant Wavelength : ±1nm**
- 3. Tolerance of Forward Voltage : ±0.1V**

**Technical Data Sheet –Top View LED**

**67-21UBC/B040/TR8/AM**

**Typical Electro-Optical Characteristics Curves**

- Typical curve of spectral distribution :

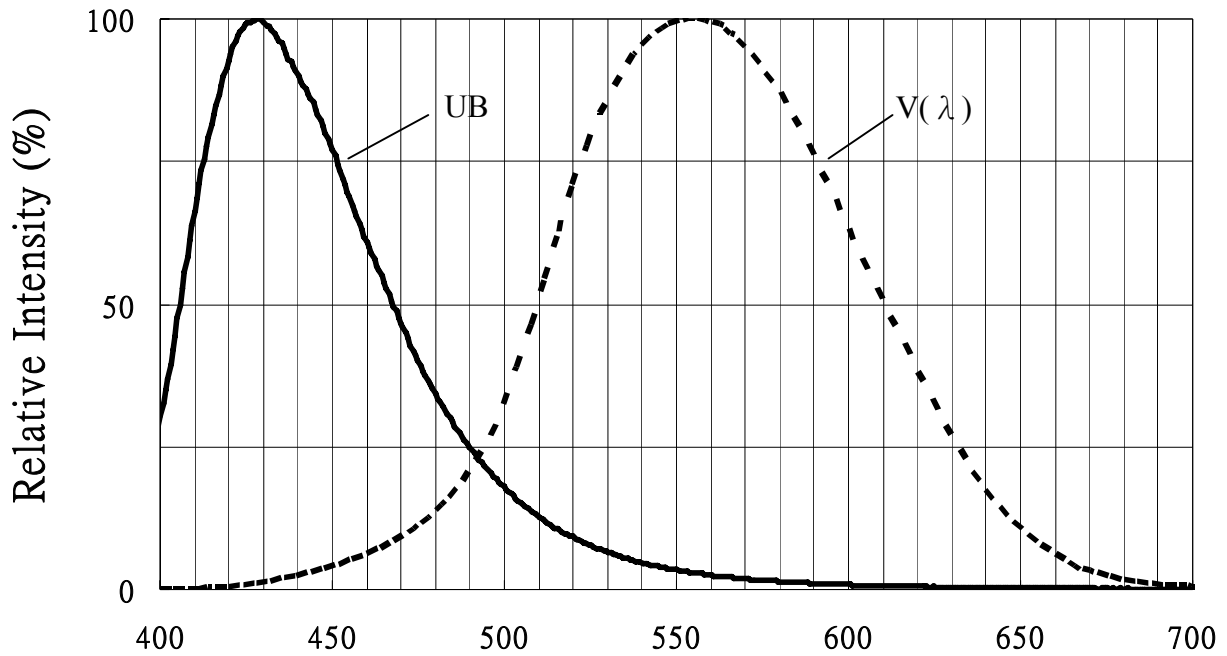

Note :  $V(\lambda)$ =Standard eye response curve       $W_p$  (nm)

**Diagram characteristics of radiation**

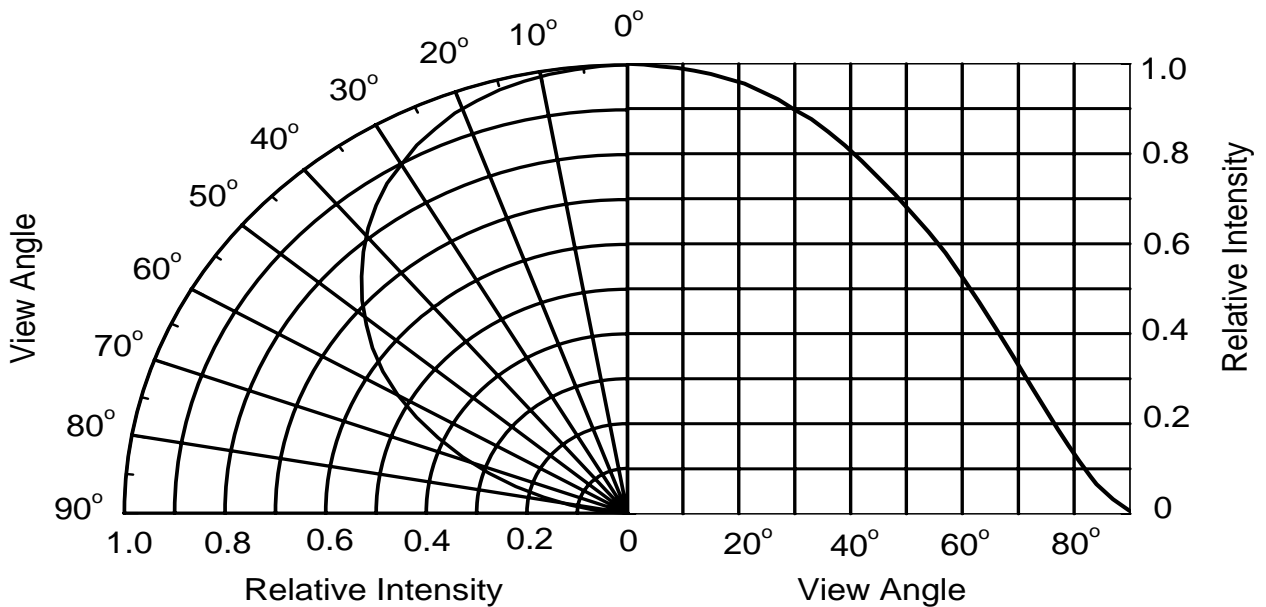

**Technical Data Sheet –Top View LED**

**67-21UBC/B040/TR8/AM**

**Forward Current vs. Forward Voltage (Ta=25°C)**

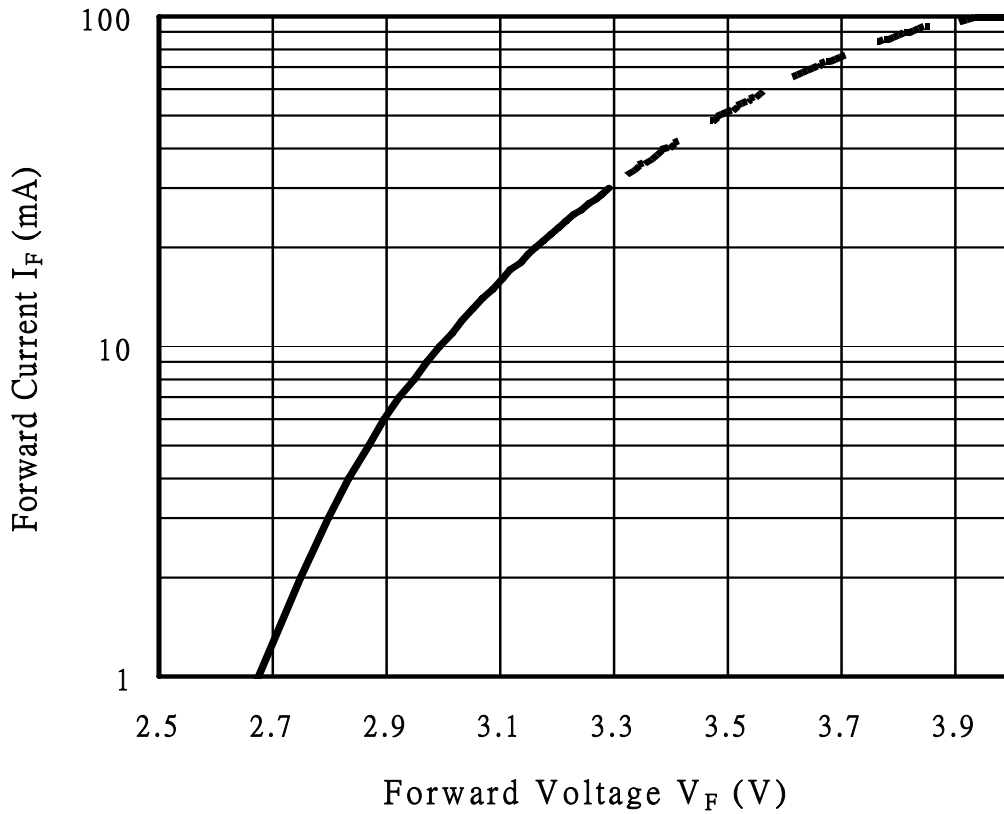

**Forward current vs. Ambient Temp.**

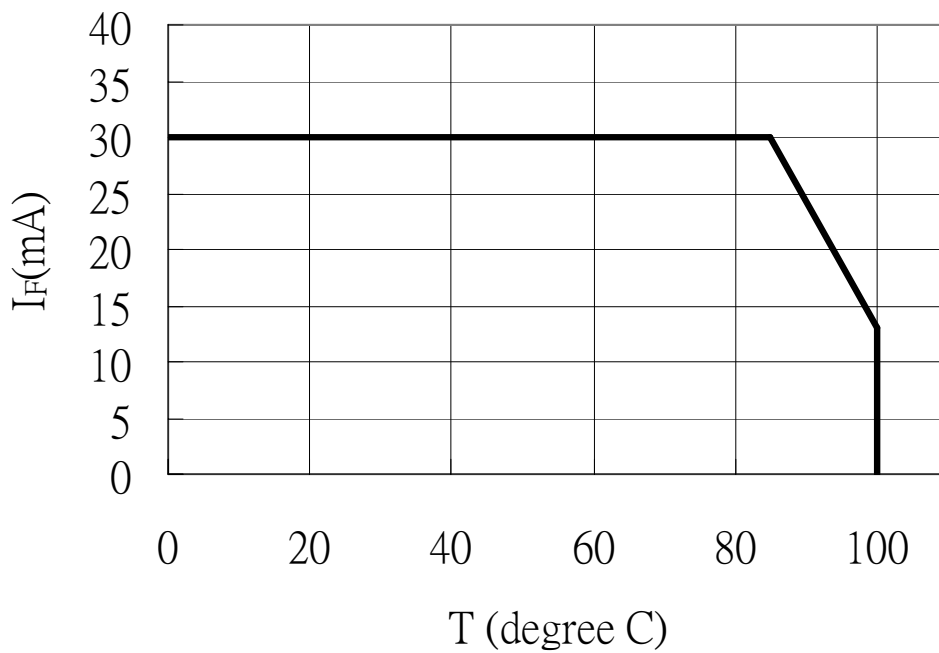

Technical Data Sheet –Top View LED

**67-21UBC/B040/TR8/AM**

**Label explanation**

- CPN : Customer's Production Number
- P/N : Production Number
- QTY : Packing Quantity
- CAT : Luminous Intensity Rank
- HUE : Dom. Wavelength Rank
- REF : Forward Voltage Rank
- LOT No : Lot Number

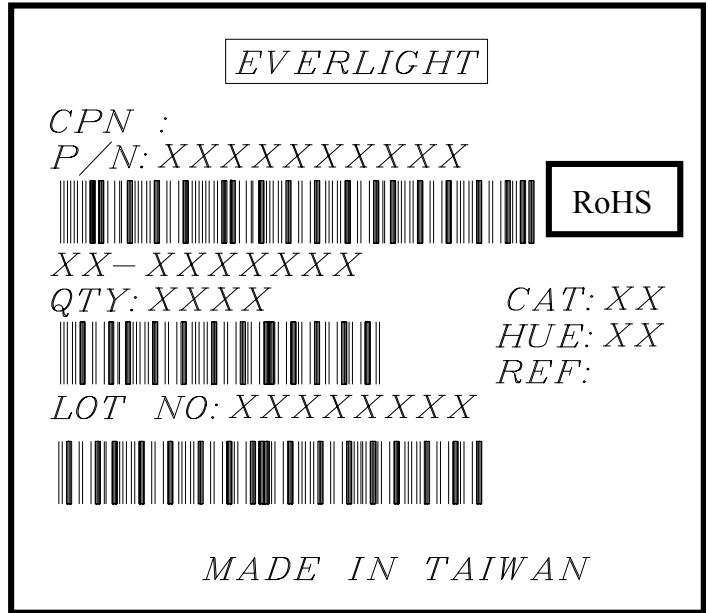

**Reel Dimensions**

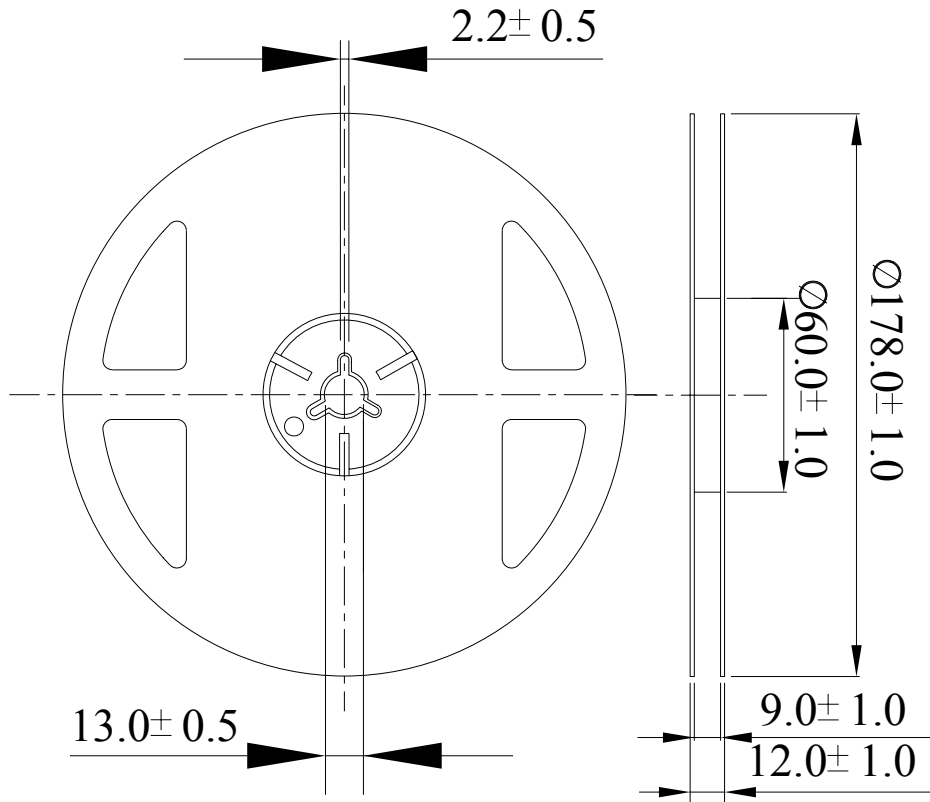

**Note :** Tolerances unless dimension ±0.1mm. Unit = mm

Technical Data Sheet –Top View LED

**67-21UBC/B040/TR8/AM**

Carrier Tape Dimensions: Loaded quantity 2000 PCS per reel

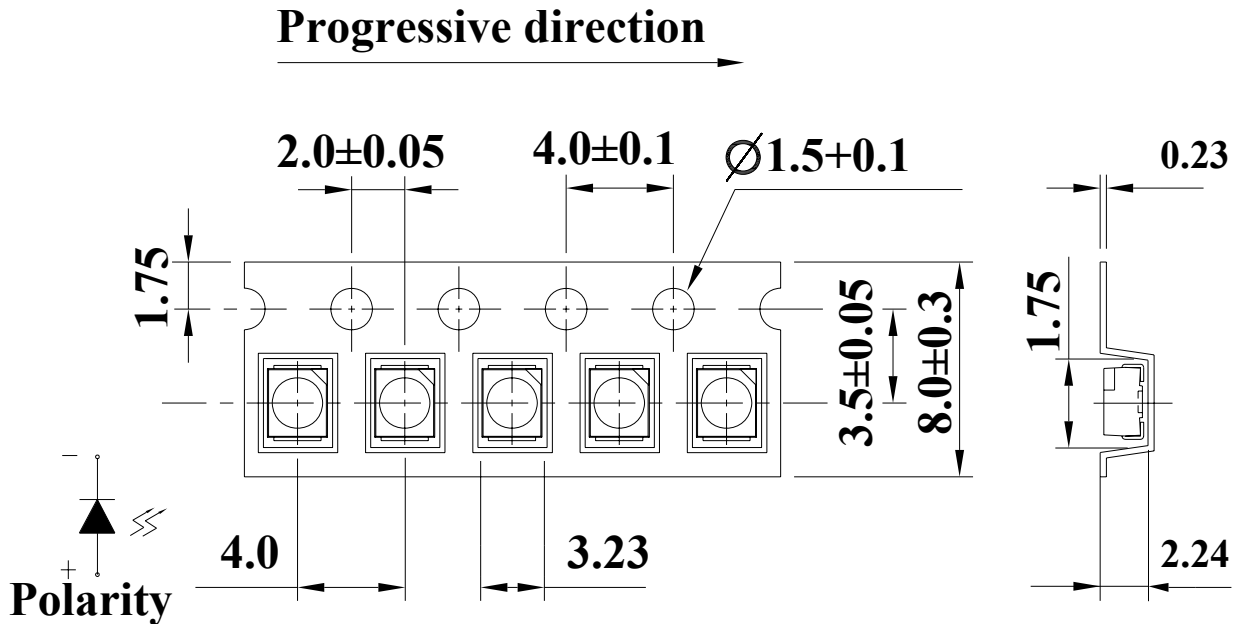

**Note :** Tolerances unless dimension  $\pm 0.1$ mm. Unit = mm

**Moisture Resistant Packaging**

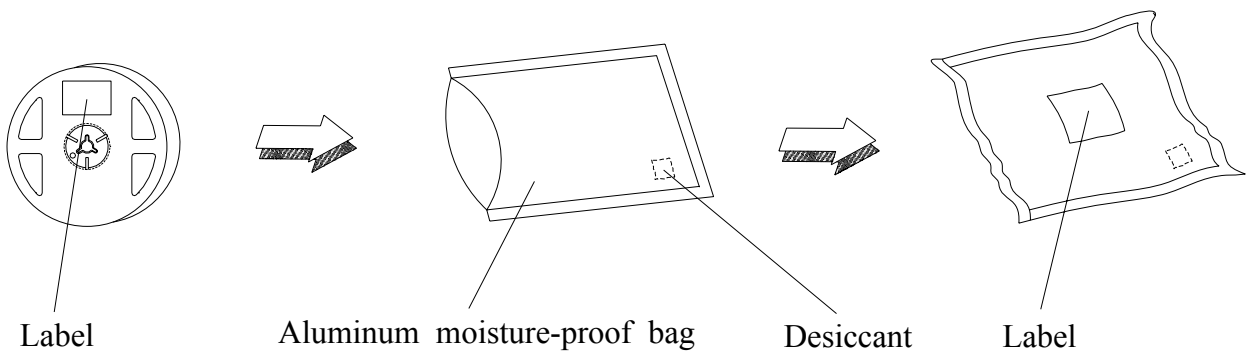



**Technical Data Sheet –Top View LED**

**67-21UBC/B040/TR8/AM**

**Precautions for Use**

1. Over-current-proof

Customer must apply resistors for protection, otherwise slight voltage shift will cause big current change ( Burn out will happen ).

2. Storage

2.1 Do not open moisture proof bag before the products are ready to use.

2.2 Before opening the package: The LED should be kept at 30°C or less and 90%RH or less.

2.3 After opening the package: The LED floor life is 1 year under 30°C or less and 60% RH or less. If unused LED remain, it should be stored in moisture proof packages.

2.4 If the moisture absorbent material (silica gel) has faded away or the LED have exceeded the storage time, baking treatment should be performed using the following conditions.

Baking treatment : 60±5°C for 24 hours.

3. Soldering Condition

3.1 (A) Pb-free solder temperature profile

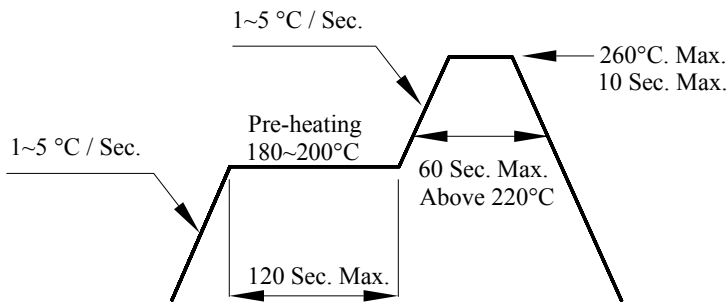

(B) Recommend soldering pad

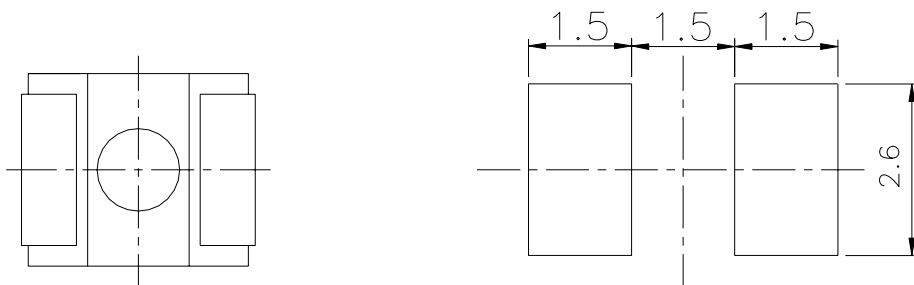



## Technical Data Sheet –Top View LED

---

**67-21UBC/B040/TR8/AM**

3.3 When soldering, do not put stress on the LED during heating.

3.4 After soldering, do not warp the circuit board.

#### 4.Soldering Iron

Each terminal is to go to the tip of soldering iron temperature less than 350°C for 3 seconds within once in less than the soldering iron capacity 25W. Leave two seconds and more intervals, and do soldering of each terminal. Be careful because the damage of the product is often started at the time of the hand solder.