

**SPECIFICATIONS**

Electrical Ratings	3A @ 120VAC; 1.5A @ 250VAC See Contact Options
Electrical Life	55,000 cycles typical
Contact Resistance	< 20 mΩ max initial @ 2-4VDC, 100mA
Dielectric Strength	1500Vrms min
Insulation Resistance	> 100MΩ min
Operating Temperature	-40°C to 85°C
Storage Temperature	-40°C to 85°C
Packaging Information	500 pieces per reel



Process Sealed - IP67, SMT

**UL** us - E222871



**MATERIALS ←RoHS COMPLIANT**

Actuator	Brass, Chrome Plated
Housing	4/6 Nylon, Glass Filled, Flame Retardant Heat Stabilized, UL94V-0
Support Bracket	Brass, Tin Plated
Contacts	Copper Alloy, Silver or Gold Plated
Terminals	Copper Alloy, Silver or Gold Plated

**ORDERING INFORMATION**

<b>Series:</b>	<b>SST</b>	<b>1</b>	<b>3</b>	<b>T2</b>	<b>N</b>	<b>K</b>	<b>G</b>
<b>SST</b>							
<b>Number of Poles:</b>							
1 = SPDT							
<b>Switch Function:</b>							
1 = ON-NONE-ON							
2 = ON-NONE-(ON)							
3 = ON-OFF-ON							
4 = (ON)-OFF-(ON)							
<b>Actuator:</b>							
T1 = 10.16mm, Std							
T2 = 6.10mm, Std							
T4 = 13.97mm, Std							
P1 = 10.16mm, Plastic, Anti-Static							
P2 = 6.10mm, Plastic, Anti-Static							
<b>Bushing:</b>							
N = 4.11mm, Non-Threaded							
<b>Terminals:</b>							
R = Standard SMT							
K = Straight SMT							
<b>Contacts:</b>							
Q = Silver Plated							
R = Gold Plated							
G = Gold over Silver Plated							

**SWITCH FUNCTION**

Function	Toggle Position		
			
1	ON	NONE	ON
2	ON	NONE	(ON)
3	ON	OFF	ON
4	(ON)	OFF	(ON)
5	ON	OFF	(ON)
<b>Terminals</b>	2-3	---	2-1



SPDT



**ACTUATOR OPTIONS**

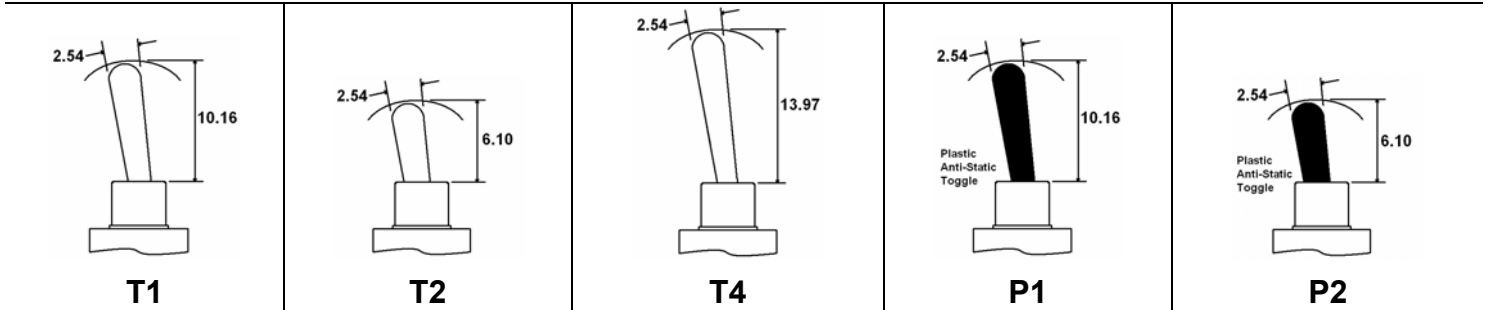

**BUSHING OPTIONS**

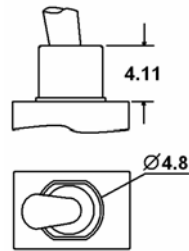

**N**

**TERMINAL OPTIONS**

**PC LAYOUTS**

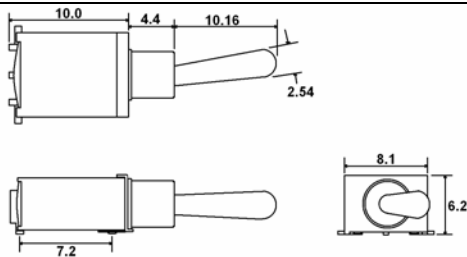

**R – SPDT**

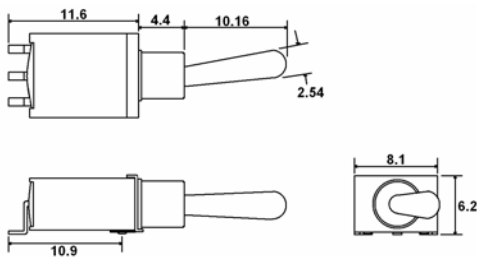
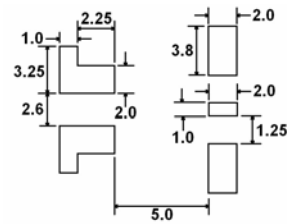

**K – SPDT**

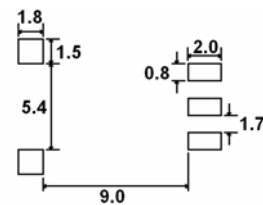

**CONTACT OPTIONS**

Designator	Contact Material	Terminal Material	Electrical Ratings
Q	Silver Plating	Silver Plating	3A @ 120VAC; 1.5A @ 250VAC
R	Gold over Nickel Plating	Gold over Nickel Plating	.4 VA max @ 20VAC or VAC max
G	Gold over Silver Plating	Gold over Silver Plating	.4 VA max @ 20VAC or VAC max or 3A @ 120VAC; 1.5A @ 250VAC