

SDR Series



- 3.2" x 5" Footprint
- Fits 1U Applications
- Low Leakage Current Option
- Up to 600 W Peak Power
- Single & Dual Outputs
- Top Fan & Convection-cooled Versions
- Output Voltages from 5 V to 60 V

Specification

Input

Input Voltage	• 90-132 VAC/180-264 VAC, auto ranging
Input Frequency	• 47-63 Hz
Input Current	• 6 A at 115 VAC, 3 A at 230 VAC
Inrush Current	• Max 70 A at 230 VAC, 35 A at 115 VAC, cold start
Power Factor	• To EN61000-3-2 Class A
Earth Leakage Current	• <1.5 mA at 264 VAC, option '-L' 500 μ A leakage current
Input Protection	• Fitted with a T6.3 A/250 V fuse on dual output models, T8 A/250 V fuse on single output models

Output

Output Voltage	• See tables
Output Voltage Trim	• \pm 5% on V1 (V2 of dual output models will track by same % of adjustment)
Initial Set Accuracy	• \pm 1%
Minimum Load	• 1% on single output models, 10% on dual output models
Start Up Delay	• 1.5 s max at 120 VAC
Start Up Rise Time	• 50 ms typical
Hold Up Time	• 20 ms min at 80% of full load
Line Regulation	• \pm 0.5%
Load Regulation	• \pm 1% 1-100% load for single outputs \pm 3% V1, \pm 7% V2 for dual outputs (except 0312 & 0512 models, \pm 10% regulation on V2)
Over/Undershoot	• 5% max
Transient Response	• 5% max deviation, recovery to within 1% in 500 μ s for a 50% load change
Ripple & Noise	• 1% pk-pk, see note 3
Overvoltage Protection	• 105-130% Vnom on output V1, recycle input to reset
Overtemperature Protection	• Measured internally with auto recovery
Overload Protection	• 110-140%
Short Circuit Protection	• Trip & restart (Hiccup mode), auto recovery
Remote On/Off	• Requires a low signal to inhibit output
Fan Supply	• 12 VDC, 300 mA, not available on '-F' version with built-in fan

General

Efficiency	• Single output models: 3.3 V & 5 V models 70%, 12 V models 80%, all other models >83% at 230 V & full load. Dual output models: >70% at 230 V & full load
Isolation	• 3000 VAC Input to Output 1500 VAC Input to Ground 100 VDC Output to Ground
Switching Frequency	• 30 kHz typical
Power Density	• 10.4 W/in ³
Signals	• Power Good goes Hi 100-500 ms after output is in regulation and goes Lo at least 1 ms before loss of regulation
MTBF	• 100 kHrs to MIL-HDBK-217F

Environmental

Operating Temperature	• 0 °C to +70 °C, derate at 2.5%/ °C from +50 °C to +70 °C for single output & forced air cooled dual output models. For convection cooled dual output models, see note 7.
Storage Temperature	• -20 °C to +85 °C
Operating Humidity	• 5-90%, non-condensing
Storage Humidity	• 5-90%, non-condensing
Cooling	• '-F' version has built-in fan, others require 16 CFM to meet forced air ratings
Operating Altitude	• 3000 m
Vibration	• 5-50 Hz, acceleration 7.35 m/s ² on X, Y and Z axis

EMC & Safety

Emissions	• FCC Part 15 & EN55022 Level B conducted
Harmonic Currents	• EN61000-3-2, EN61000-3-3
ESD Immunity	• EN61000-4-2, level 3 Perf Criteria A
Radiated Immunity	• EN61000-4-3, 3 V/m Perf Criteria A
EFT/Burst	• EN61000-4-4, level 2 Perf Criteria A
Surge	• EN61000-4-5, level 3 Perf Criteria A
Conducted Immunity	• EN61000-4-6, 3V Perf Criteria A
Dips & Interruptions	• EN61000-4-11 70% U _r for 10 ms, 40% U _r for 100 ms, <5% U _r for 5000 ms Perf Criteria A, B, B
Safety Approvals	• UL60950-1, CSA C22.2 No. 950, EN60950-1:2001, CE Mark LVD

Models and Ratings

Output Voltage	Output Power	Output Current		Ripple & Noise Pk-Pk ⁽³⁾	Model Number ^(1,4,5)
		Nominal	Peak ⁽²⁾		
5 V	200 W	40.00 A	120.00 A	50 mV	SDR250AS05-F
9 V	225 W	25.00 A	66.67 A	90 mV	SDR250AS09-F
12 V	250 W	20.83 A	50.00 A	120 mV	SDR250AS12-F
15 V	250 W	16.70 A	40.00 A	150 mV	SDR250AS15-F
18 V	250 W	13.89 A	33.30 A	180 mV	SDR250AS18-F
24 V	250 W	10.42 A	25.00 A	240 mV	SDR250AS24-F
28 V	250 W	8.93 A	21.43 A	280 mV	SDR250AS28-F
36 V	250 W	6.94 A	16.67 A	360 mV	SDR250AS36-F
48 V	250 W	5.21 A	12.50 A	480 mV	SDR250AS48-F
54 V	250 W	4.63 A	11.10 A	540 mV	SDR250AS54-F
60 V	250 W	4.17 A	10.00 A	600 mV	SDR250AS60-F

Output Voltage	Output Power	Output Current		Ripple & Noise Pk-Pk ⁽³⁾	Model Number ^(1,4,5)
		Nominal	Peak ⁽²⁾		
V1 : +3.3 V	200 W	24 A	28.8 A	50 mV	SDR250AD0312-F
V2 : +12.0 V		12 A	14.4 A	120 mV	
V1 : +3.3 V	200 W	24 A	28.8 A	50 mV	SDR250AD0324-F
V2 : +24.0 V		6 A	7.2 A	240 mV	
V1 : +5.0 V	200 W	24 A	28.8 A	50 mV	SDR250AD0512-F
V2 : +12.0 V		12 A	14.4 A	120 mV	
V1 : +5.0 V	200 W	24 A	28.8 A	50 mV	SDR250AD0524-F
V2 : +24.0 V		6 A	7.2 A	240 mV	
V1 : +5.0 V	200 W	24 A	28.8 A	50 mV	SDR250AD0548-F
V2 : +48.0 V		3 A	3.6 A	480 mV	
V1 : +12.0 V	250 W	12 A	14.4 A	120 mV	SDR250AD1224-F
V2 : +24.0 V		6 A	7.2 A	240 mV	

Notes

1. Add suffix 'L' to model number for optional 500 µA leakage current.
2. Peak load can be taken for 500 µs. Average power not to exceed max power.
3. Ripple & noise is measured using a 0.1 µF ceramic capacitor in parallel with 22 µF electrolytic and 20 MHz bandwidth.
4. Add suffix 'D' for optional output terminal block except the 5 V and 9 V output models which are only available with output terminal blocks.
5. Add suffix 'E' for optional input terminal block.

Mechanical Details

Enclosed with top fan

All dimensions are in inches (mm).
Weight: 430 g (0.95 lbs)

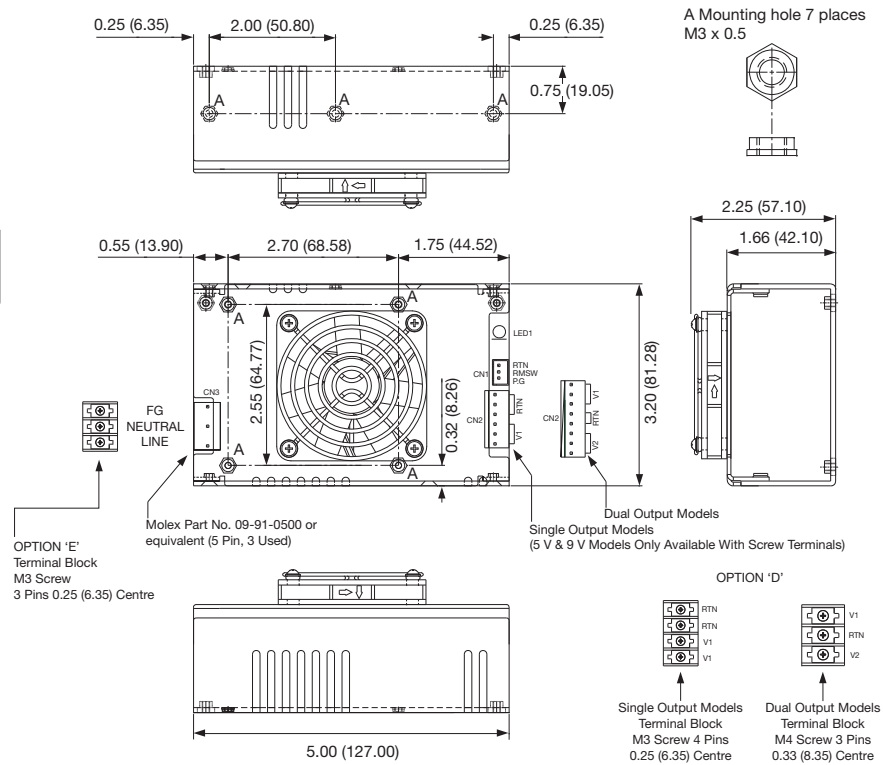
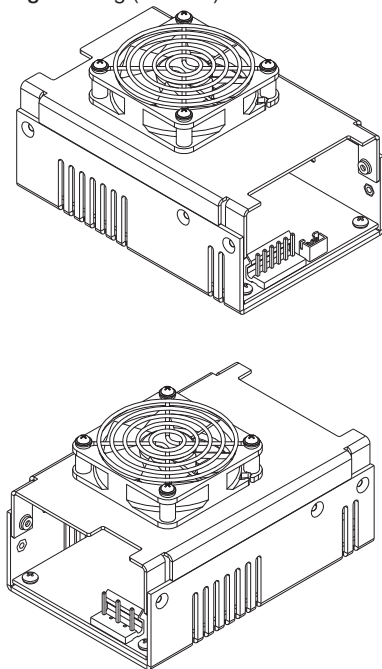

Signal connector CN1 mates with JST XHP-3 or equivalent & crimp terminals SXH-002-P0.6.
 Input: Molex No. 09-91-0500, crimp terminals Molex series 6838.
 Output: Molex No. 09-91-0600 for 12 V to 60 V single output models, 09-91-0800 for dual output models, crimp terminals Molex series 6838.
 Terminal block for 5 V to 9 V single output models.



Mechanical Details

Output Voltage	Forced Air Cooled		Convection-cooled		Peak Current ⁽²⁾	Ripple & Noise Pk-Pk ⁽³⁾	Model Number ^(1,4,5,6)
	Output Power	Output Current	Output Power	Output Current			
5 V	200 W	40.00 A	100 W	20.00 A	120.00 A	50 mV	SDR250AS05
9 V	225 W	25.00 A	121 W	13.50 A	66.67 A	90 mV	SDR250AS09
12 V	250 W	20.83 A	135 W	11.23 A	50.00 A	120 mV	SDR250AS12
15 V	250 W	16.70 A	135 W	9.00 A	40.00 A	150 mV	SDR250AS15
18 V	250 W	13.89 A	135 W	7.50 A	33.30 A	180 mV	SDR250AS18
24 V	250 W	10.42 A	135 W	5.63 A	25.00 A	240 mV	SDR250AS24
28 V	250 W	9.93 A	135 W	4.82 A	21.43 A	330 mV	SDR250AS28
36 V	250 W	6.94 A	135 W	3.75 A	16.67 A	360 mV	SDR250AS36
48 V	250 W	5.21 A	135 W	2.81 A	12.30 A	480 mV	SDR250AS48
54 V	250 W	4.63 A	135 W	2.50 A	11.10 A	540 mV	SDR250AS54
60 V	250 W	4.17 A	135 W	2.25 A	10.00 A	600 mV	SDR250AS60

Output Voltage	Forced Air Cooled		Convection-cooled		Peak Current ⁽²⁾	Ripple & Noise Pk-Pk ⁽³⁾	Model Number ^(1,4,5,6,7)
	Output Power	Output Current	Output Power	Output Current			
V1 : +3.3 V V2 : +12.0 V	200 W	24 A	100 W	12 A	28.8 A	50 mV	SDR250AD0312
		12 A		7 A	14.4 A	120 mV	
V1 : +3.3 V V2 : +24.0 V	200 W	24 A	100 W	12 A	28.8 A	50 mV	SDR250AD0324
		6 A		4 A	7.2 A	240 mV	
V1 : +5.0 V V2 : +12.0 V	200 W	24 A	100 W	12 A	28.8 A	50 mV	SDR250AD0512
		12 A		7 A	14.4 A	120 mV	
V1 : +5.0 V V2 : +24.0 V	200 W	24 A	100 W	12 A	28.8 A	50 mV	SDR250AD0524
		6 A		4 A	7.2 A	240 mV	
V1 : +5.0 V V2 : +48.0 V	200 W	24 A	100 W	12 A	28.8 A	50 mV	SDR250AD0548
		3 A		2 A	3.6 A	480 mV	
V1 : +12.0 V V2 : +24.0 V	250 W	12 A	135 W	7 A	14.4 A	120 mV	SDR250AD1224
		6 A		4 A	7.2 A	240 mV	

Notes

1. Add suffix 'L' to model number for optional 500 µA leakage current.
2. Peak load can be taken for 500 µs. Average power not to exceed max power.
3. Ripple & noise is measured using a 0.1 µF ceramic capacitor in parallel with 22 µF electrolytic and 20 MHz bandwidth.
4. For optional vented cover add suffix '-C' to model number.
5. Add suffix 'D' for optional output terminal block except the 5 V and 9 V output models which are only available with output terminal blocks.
6. Add suffix 'E' for optional input terminal block.
7. Operating temperature - 0 °C to +60 °C, derate at 5%/°C from 50 °C to 60 °C for convection cooled dual output models.

Mechanical Details

U-Channel

All dimensions are in inches (mm).
Weight: 400 g (0.88 lbs)

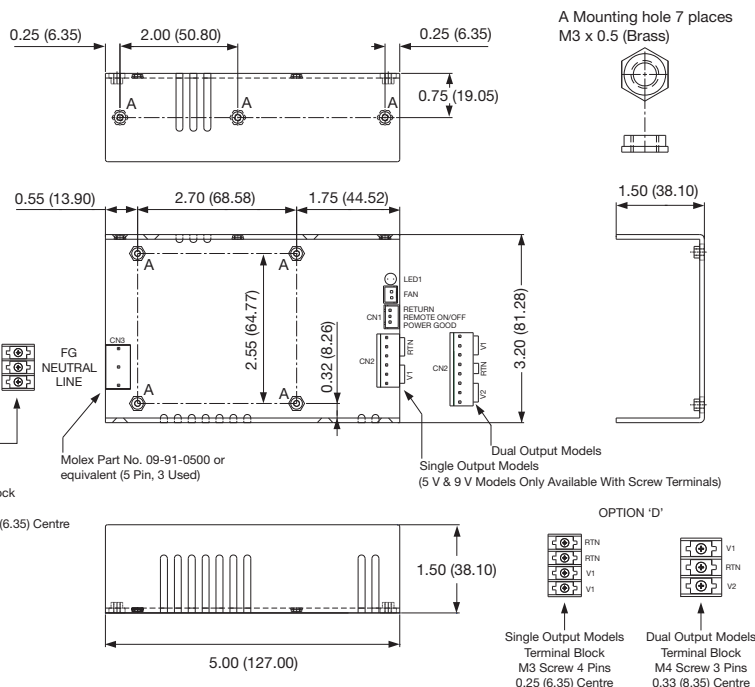
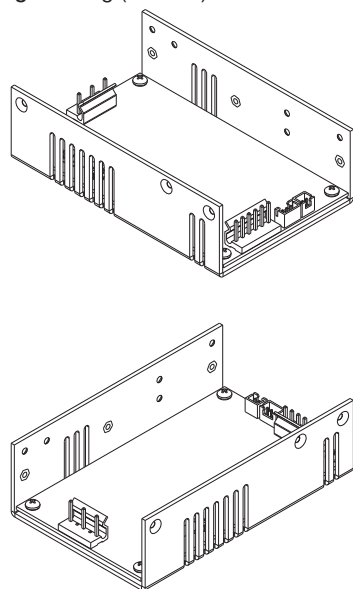

Signal connector CN1 mates with JST XHP-3 or equivalent & crimp terminals SXH-002-P0.6.

Fan connector mates with JST XHP-2 or equivalent & crimp terminals.

Input: Molex No. 09-91-0500, crimp terminals Molex series 6838.

Output: Molex No. 09-91-0600 for 12 V to 60 V single output models, 09-91-0800 for dual output models, crimp terminals Molex series 6838.

Terminal block for 5 V to 9 V single output models.

U-Channel with cover (Option '-C')

All dimensions are in inches (mm).
Weight: 420 g (0.93 lbs)

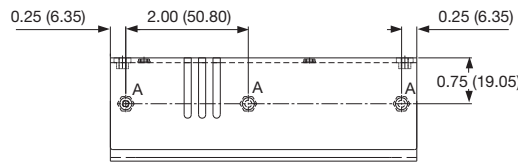
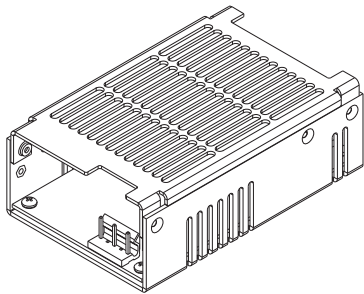
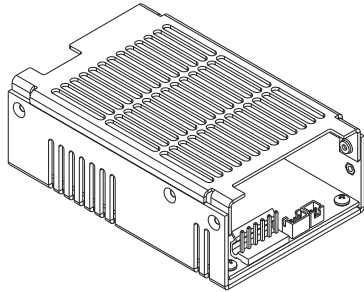

A Mounting hole 7 places
M3 x 0.5

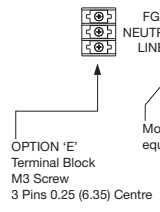
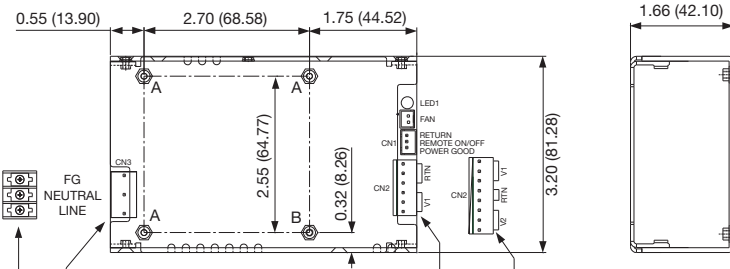

OPTION 'E'
Terminal Block
M3 Screw
3 Pins 0.25 (6.35) Centre

Molex Part No. 09-91-0500 or equivalent (5 Pin, 3 Used)

Dual Output Models
Single Output Models

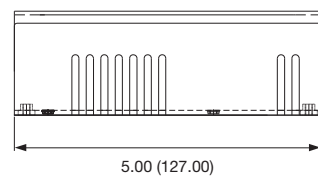

OPTION 'D'

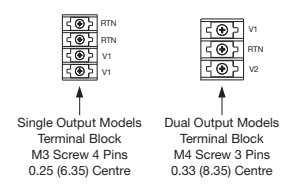

Signal connector CN1 mates with JST XHP-3 or equivalent & crimp terminals SXH-002-P0.6.
Fan connector mates with JST XHP-2 or equivalent & crimp terminals.
Input: Molex No. 09-91-0500, crimp terminals Molex series 6838.
Output: Molex No. 09-91-0600 for 12 V to 60 V single output models, 09-91-0800 for dual output models, crimp terminals Molex series 6838.
Terminal block for 5 V to 9 V single output models

Application Notes

Remote On/Off

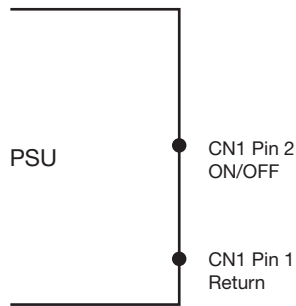

- Note:**
1. Applying <math><0.3\text{ V}</math> or short between pins 2 and 1 turns the output OFF.
 2. Applying >math>>4.5\text{ V}</math> or open circuit between pins 2 and 1 turns output ON.

Power Good

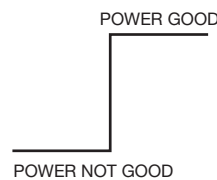
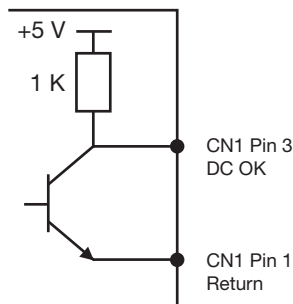

Sink current = 6 mA
Source current = 4 mA