

**M2FL20U****200V 1.5A****特長**

- 小型SMD
- 低ノイズ
- trr=35ns
- 低VF=0.92V

**Feature**

- Small SMD
- Low Noise
- trr=35ns
- Low VF=0.92V

**用途**

- スイッチング電源
- DC/DCコンバータ
- 家電、OA
- 通信

**Main Use**

- Switching Regulator
- DC/DC Converter
- Home Appliance, Office Automation
- Communication

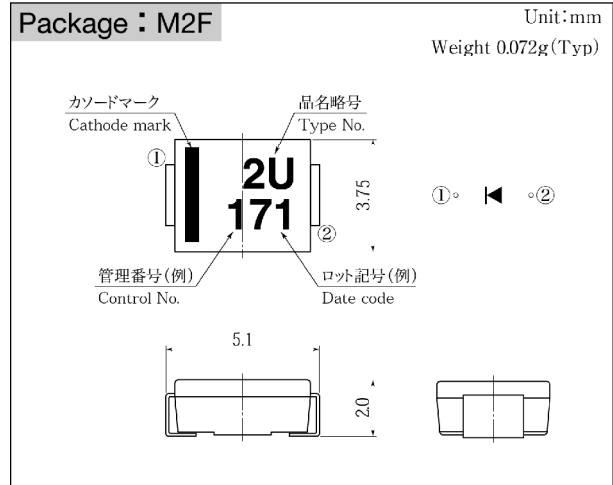
**■外観図 OUTLINE**

外形図については新電元Webサイト又は〈ダイオードカタログ・技術資料編〉を参照下さい。捺印表示については捺印仕様をご確認下さい。

For details of the outline dimensions, refer to our web site or the diode technical data book. As for the marking, refer to the specification "Marking, Terminal Connection".

**■定格表 RATINGS****●絶対最大定格 Absolute Maximum Ratings (指定のない場合  $T_l = 25^\circ\text{C}$ )**

項目 Item	記号 Symbol	条件 Conditions	品名 Type No.	M2FL20U	単位 Unit
保存温度 Storage Temperature	$T_{stg}$			-55~150	℃
接合部温度 Operation Junction Temperature	$T_j$			150	℃
せん頭逆電圧 Maximum Reverse Voltage	$V_{RM}$			200	V
出力電流 Average Rectified Forward Current	$I_o$	50Hz正弦波, 抵抗負荷 50Hz sine wave, Resistance load	$T_a = 32^\circ\text{C}$ プリント基板実装 On glass-epoxy substrate	1.2	A
			$T_a = 31^\circ\text{C}$ アルミナ基板実装 On alumina substrate	1.5	
せん頭サージ順電流 Peak Surge Forward Current	$I_{FSM}$	50Hz正弦波, 非繰り返し1サイクルせん頭値, $T_j = 25^\circ\text{C}$ 50Hz sine wave, Non-repetitive 1 cycle peak value, $T_j = 25^\circ\text{C}$		50	A

**●電氣的・熱的特性 Electrical Characteristics (指定のない場合  $T_l = 25^\circ\text{C}$ )**

順電圧 Forward Voltage	$V_F$	$I_F = 1.5\text{A}$ , パルス測定 Pulse measurement		MAX 0.92	V
逆電流 Reverse Current	$I_R$	$V_R = V_{RM}$ , パルス測定 Pulse measurement		MAX 10	$\mu\text{A}$
逆回復時間 Reverse Recovery Time	trr	$I_F = 0.5\text{A}$ , $I_R = 1\text{A}$		MAX 35	ns
熱抵抗 Thermal Resistance	$\theta_{jl}$	接合部・リード間 Junction to lead		MAX 33	℃/W
			$\theta_{ja}$	接合部・周囲間 Junction to ambient	
	プリント基板実装 On glass-epoxy substrate	MAX 120			

★記載内容は製品改良のためにお断りなしに変更することがあります。

★All specifications are subject to change without notice.

■特性図 CHARACTERISTIC DIAGRAMS

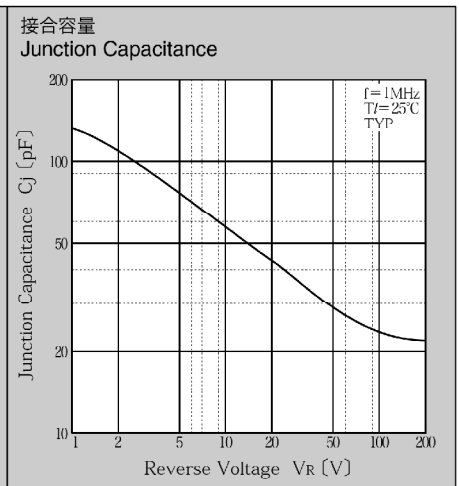
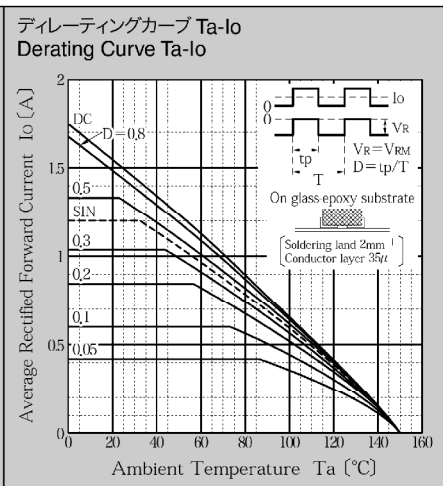
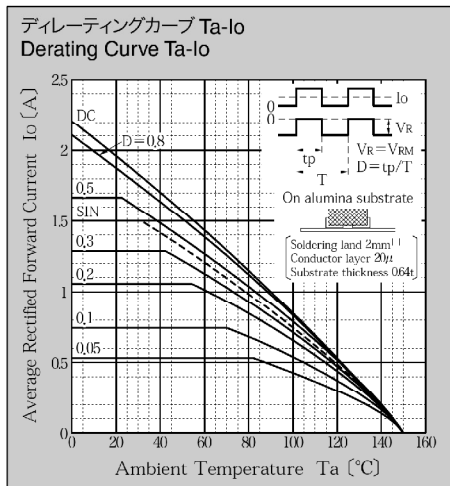
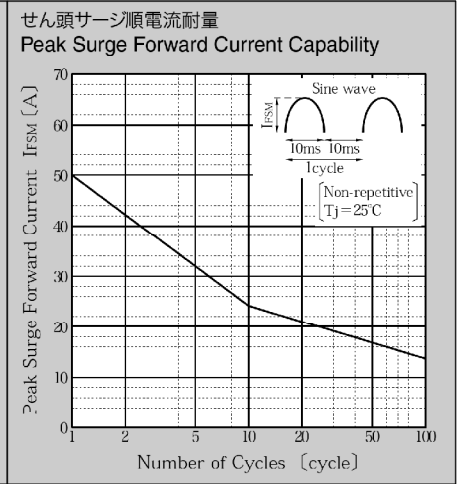
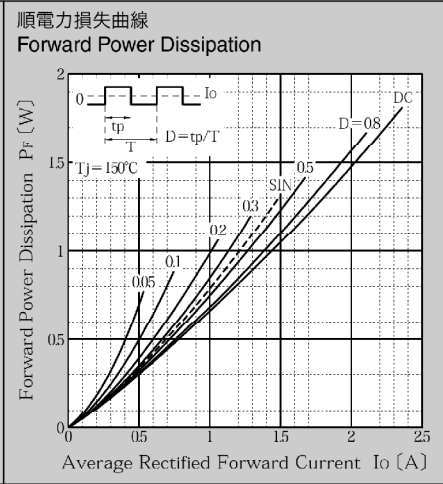
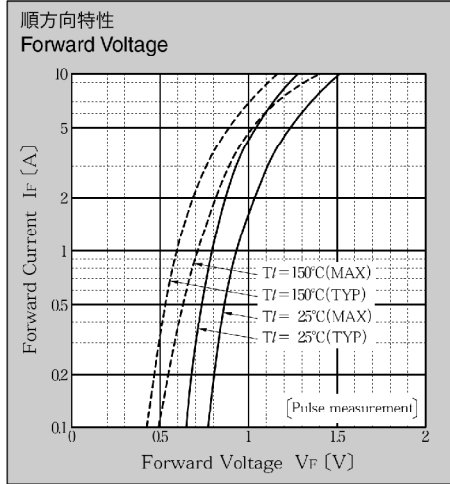

\* Sine waveは50Hzで測定しています。  
 \* 50Hz sine wave is used for measurements.  
 \* 半導体製品の特性は一般的にバラツキを持っています。  
 Typicalは統計的な実力を表しています。  
 \* Semiconductor products generally have characteristic variation.  
 Typical is a statistical average of the device's ability.