

J_N-1W Series

**1W, FIXED INPUT, ISOLATED & NON-REGULATED
QUAD OUTPUT, DIP PACKAGE DC-DC CONVERTER**

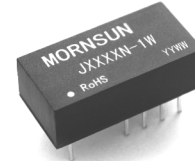

multi-country patent protection **RoHS**

FEATURES

1KVDC Isolation
DIP Package
Temperature Range: -40°C to +85°C
Internal SMD construction
UL94-V0 Package
No Heat sink Required
No External Component Required
Industry Standard Pinout
RoHS Compliance

APPLICATIONS

J_N-1W Series is specially designed for applications where a group of polar power supplies are isolated from the input power supply in a distributed power supply system on a circuit board.

These products apply to:

- 1) Where the voltage of the input power supply is fixed (voltage variation $\leq \pm 10\%$);
- 2) Where isolation is necessary between input and output (isolation voltage $\leq 1000\text{VDC}$);
- 3) Where the regulation of the output voltage and the output ripple noise are not demanding.

Such as: purely digital circuits, ordinary low frequency analog circuits, and IGBT power device driving circuits.

MODEL SELECTION

J0505N-1W

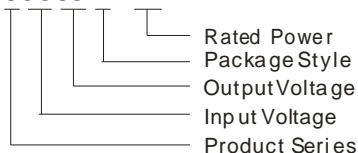

MORNSUN Science & Technology co., Ltd.

Address: 2th floor 6th building, Hangzhou Industrial District, Guangzhou, China
Tel: 86-20-38601850
Fax: 86-20-38601272
<http://www.mornsun-power.com>

PRODUCT PROGRAM

Part Number	Input		Output Voltage (VDC)S	Output Current (mA)		Efficiency (% Typ)
	Voltage (VDC)			Max	Min	
	Nominal	Range				
J0505N-1W	5	4.5-5.5	5	50	5	73

ISOLATION SPECIFICATIONS

Item	Test conditions	Min	Typ	Max	Units
Isolation voltage	Tested for 1 minute and 1mA max(Vin/Vout)	1000			VDC
	Tested for 1 minute and 1mA max(Vout/Vout)	1000			
Isolation resistance	Test at 500VDC(Vin/Vout)	1000			MΩ
	Test at 500VDC(Vout/Vout)	1000			
Isolation capacitance			40		pF

COMMON SPECIFICATIONS

Item	Test conditions	Min	Typ	Max	Units
Storage humidity				95	%
Operating temperature		-40		85	°C
Storage temperature		-55		125	
Lead temperature			15	25	
Temp. rise at full load	1.5mm from case for 10 seconds			300	
Cooling		Free air convection			
Case material		Plastic(UL94-V0)			
Short circuit protection*				1	S
MTBF		3500			K hours
Weight			1.05		g

*Supply voltage must be discontinued at the end of short circuit duration.

OUTPUT SPECIFICATIONS

Item	Test conditions	Min	Typ	Max	Units
Output power		0.1		1	W
Line regulation	For Vin change of 1%			± 1.2	%
Load regulation	10% to 100% load			15	
Output voltage accuracy		See tolerance envelope graph			
Temperature drift	100% full load			0.03	%/°C
Ripple & Noise*	20MHz Bandwidth		50	75	mVp-p
Switching frequency	Full load, nominal input		100		KHz

*Test ripple and noise by "parallel cable" method. See detailed operation instructions at Testing of Power Converter section, application notes.

Note:

1. All specifications measured at TA=25°C, humidity<75%, nominal input voltage and rated output load unless otherwise specified.
2. See below recommended circuits for more details.

TYPICAL CHARACTERISTICS

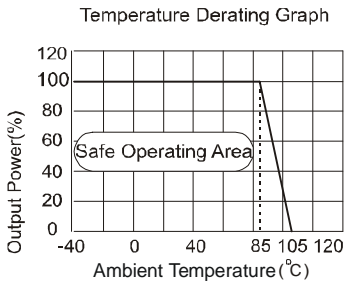
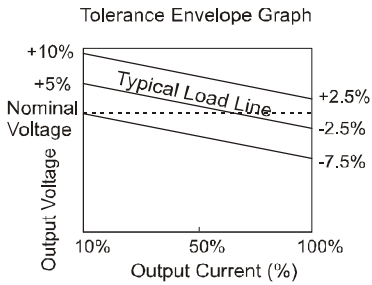

EXTERNAL CAPACITOR TABLE (TABLE 1)

Vin(VDC)	Cin(uF)	Vout(VDC)	Cout(uF)
5	4.7	5	1
12	2.2	-	-
24	1	-	-

It's not recommended to connect any external capacitor in the application field with less than 0.5 watt output.

Output Voltage Regulation and Over-voltage Protection Circuit

The simplest device for output voltage regulation, over-voltage and over-current protection is a linear voltage regulator with overheat protection that is connected to the input or output end in series (Figure 2).

OUTLINE DIMENSIONS & PIN CONNECTIONS

First Angle Projection

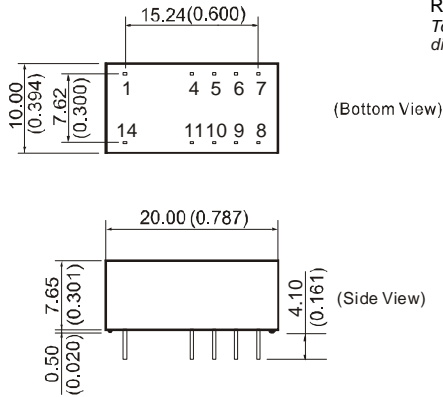

RECOMMENDED FOOTPRINT
Top view, grid: 2.54*2.54mm(0.1*0.1inch), diameter: 1.00mm(.039inch)

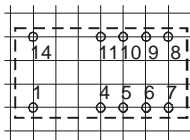

FOOTPRINT DETAILS

Pin	Function
1	GND
4	0V3
5	+Vo3
6	0V4
7	+Vo4
8	+Vo2
9	0V2
10	+Vo1
11	0V1
14	+Vin

Note:
Unit:mm(inch)
Pin section:0.50*0.30mm(0.020*0.012inch)
Pin section tolerances:±0.10mm(±0.004inch)
General tolerances:±0.25mm(±0.010inch)

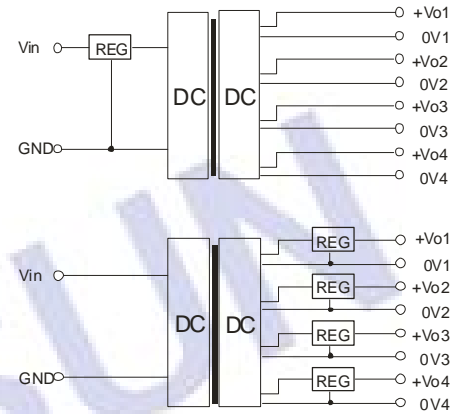

(Figure 2)

Overload Protection

Under normal operating conditions, the output circuit of these products has no protection against overload. The simplest method is to connect a self-recovery fuse in series at the input end or add a circuit breaker to the circuit.

Requirement on output load

To ensure this module can operate efficiently and reliably, During operation, the minimum output load is not less than 10% of the full load, and that this product should never be operated under no load! If the actual output power is very small, please connect a resistor with proper resistance at the output end in parallel to increase the load, or use our company's products with a lower rated output power.

No parallel connection or plug and play.

APPLICATION NOTE

Recommended circuit

If you want to further decrease the input/output ripple, an "LC" filtering network may be connected to the input and output ends of the DC/DC converter, see (Figure 1).

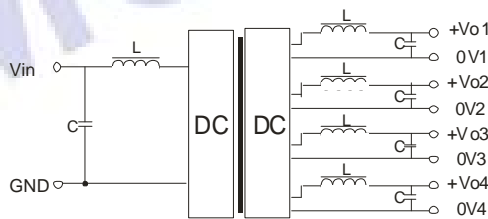

(Figure 1)

It should also be noted that the inductance and the frequency of the "LC" filtering network should be staggered with the DC/DC frequency to avoid mutual interference. However, the capacitance of the output filter capacitor must be proper. If the capacitance is too big, a startup problem might arise. For every channel of output, provided the safe and reliable operation is ensured, the greatest capacitance of its filter capacitor sees (Table 1).