

17 - 27 GHz Packaged Upconverter

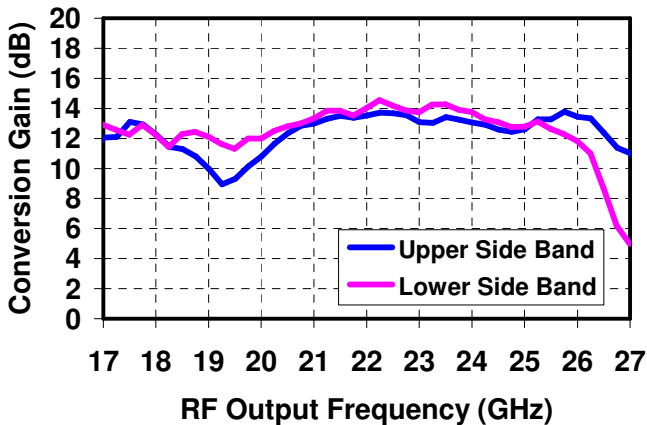

Measured Performance

Vd = 5V, Idq = 425mA, Vmxr = Vdbl = -0.9V
 IF = 2GHz @ -8dBm, +2dBm LO



Vd = 5V, Idq = 425mA, Vmxr = Vdbl = -0.9V
 IF = 2GHz +/- 5MHz @ -8dBm Input/Tone, +2dBm LO

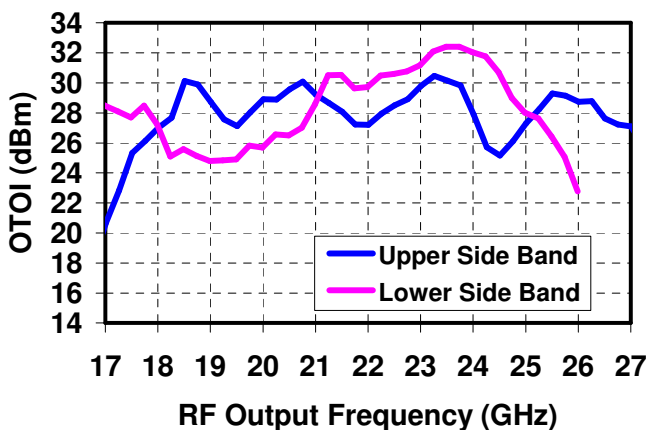

Key Features

- RF Output Frequency Range: 17 - 27 GHz
- LO Input Frequency Range: 8 - 13 GHz
- IF Input Frequency Range: 0.5 - 3 GHz
- 13 dB Conversion Gain
- 28 dBm OTOI
- Bias: Vd = 5 V, Idq = 425 mA
- Package Dimensions: 4 x 4 x 0.9 mm

Primary Applications

- Point-to-Point Radio
- K Band Sat-Com

Product Description

The TriQuint TGC4405-SM is an upconverter with RF output frequencies of 17 to 27 GHz. It contains a frequency doubler and local oscillator (LO) amplifier, operating at LO input frequencies of 8 - 13 GHz. The TGC4405-SM is in a compact 4 mm x 4 mm package footprint.

The TGC4405-SM nominally provides 13 dB conversion gain and 28 dBm OTOI when operated with LO inputs from 2 - 5 dBm.

The TGC4405-SM is ideally suited for low cost markets such as Point-to-Point Radio, and K-band Sat-Com.

The TGC4405-SM has a protective surface passivation layer on the MMIC providing environmental robustness.

Lead-free and RoHS compliant.

Datasheet subject to change without notice.

Table I
Absolute Maximum Ratings 1/

Symbol	Parameter	Value	Notes
Vd-Vg	Drain to Gate Voltage	12 V	
Vd	Drain Supply Voltage	8 V	2/
Vmxr	Mixer Supply Voltage Range	-5 to 0 V	
Vdbl	Doubler Supply Voltage Range	-5 to 0 V	
Vg	Gate Supply Voltage Range	-5 to 0 V	
Id	Drain Supply Current	817 mA	2/
Ig	Gate Supply Current Range	-3.3 to 56.7 mA	
Imxr	Mixer Supply Current Range	-0.75 to 10.5 mA	
Idbl	Doubler Supply Current Range	-0.6 to 16.8 mA	
Pin _{LO}	LO Input Continuous Wave Power	18 dBm	2/
Pin _{IF}	IF Input Continuous Wave Power	21 dBm	2/

- 1/ These ratings represent the maximum operable values for this device. Stresses beyond those listed under "Absolute Maximum Ratings" may cause permanent damage to the device and / or affect device lifetime. These are stress ratings only, and functional operation of the device at these conditions is not implied.
- 2/ Combinations of supply voltage, supply current, input power, and output power shall not exceed Pd (as listed in "Thermal Information").

Table II
Recommended Operating Conditions

Symbol	Parameter	Value
Vd	Drain Voltage	5 V
Idq	Drain Current	425 mA
Vg	Gate Voltage	-0.5 V, typical
Vmxr	Mixer Voltage	-0.9 V
Vdbl	Doubler Voltage	-0.9 V

See assembly diagram for bias instructions.

Table III
RF Characterization Table

Bias: $V_d = 5\text{ V}$, $I_{dq} = 425\text{ mA}$, $V_{mxr} = V_{dbl} = -0.9\text{V}$, $V_g = -0.5\text{V}$ Typical

SYMBOL	PARAMETER	TEST CONDITIONS	NOMINAL	UNITS
F_{LO}	LO Input Frequency Range		8 - 13	GHz
F_{IF}	IF Input Frequency Range		0.5 - 3	GHz
Gain	Conversion Gain	$f = 17 - 27\text{ GHz}$	13	dB
ORL	Output Return Loss	$f = 17 - 27\text{ GHz}$	-10	dB
OTOI	Output Third Order Intercept @ IF Input = -8dBm/Tone	$f = 17 - 27\text{ GHz}$	28	dBm

Table IV
Power Dissipation and Thermal Properties

Parameter	Test Conditions	Value	Notes
Maximum Power Dissipation	Tbase = 70 °C	Pd = 2.9 W Tchannel = 150 °C Tm = 1.0E+6 Hrs	1/ 2/
Thermal Resistance, θ_{jc}	Vd = 5 V Id = 425 mA Pd = 2.13 W	θ_{jc} = 27.4 (°C/W) Tchannel = 128 °C Tm = 7E+6 Hrs	
Mounting Temperature	30 Seconds	320 °C	
Storage Temperature		-65 to 150 °C	

- 1/ For a median life of 1E+6 hours, Power Dissipation is limited to
 $Pd(max) = (150\text{ °C} - Tbase\text{ °C})/\theta_{jc}$.
- 2/ Channel operating temperature will directly affect the device median time to failure (MTTF). For maximum life, it is recommended that channel temperatures be maintained at the lowest possible levels.
- 2/ Tbase is defined @ package pin # 17 (ground)

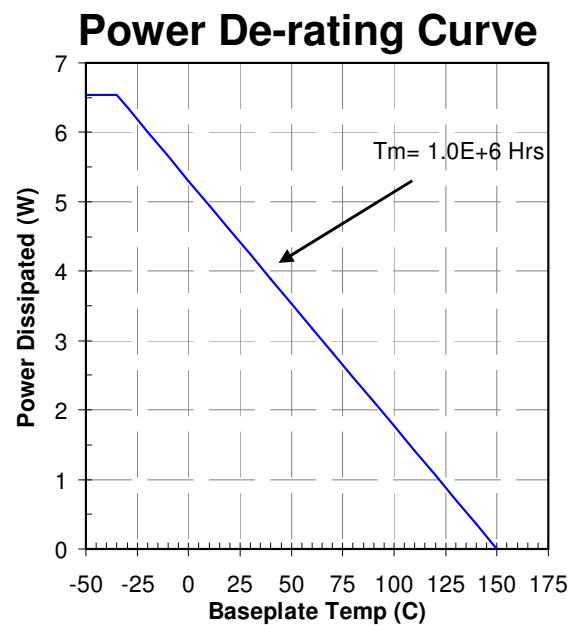

Measured Data

Vd = 5V, Idq = 425mA, Vm_{xr} = Vd_{bl} = -0.9V
 IF = 2GHz @ -8dBm, +2dBm LO

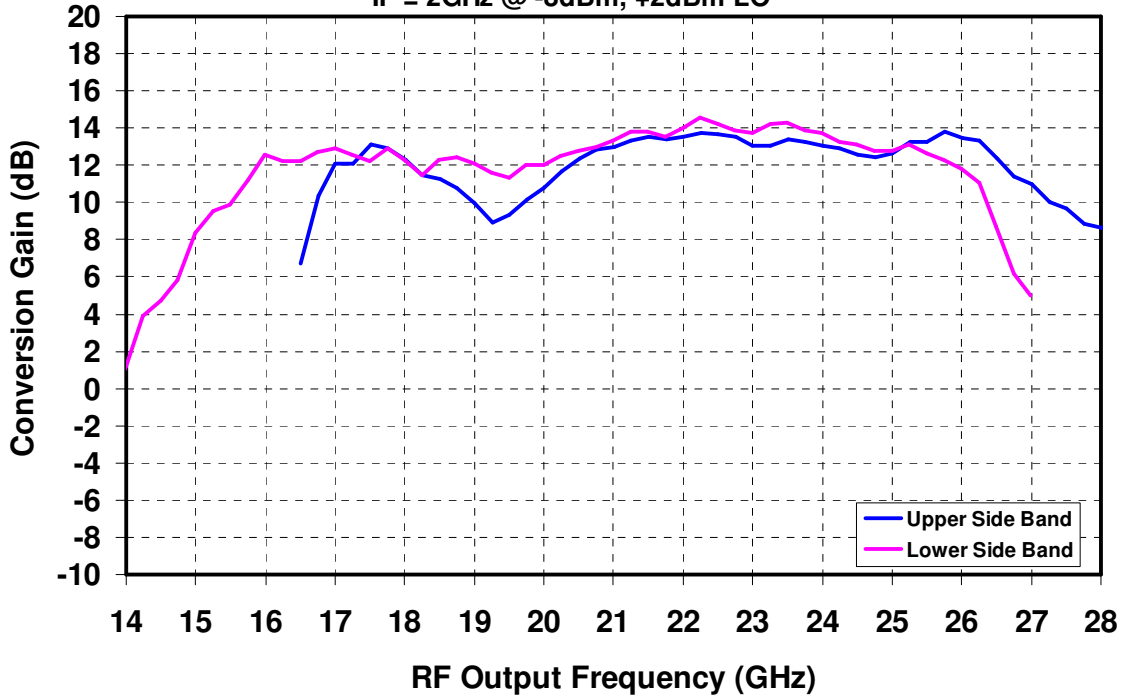

Vd = 5V, Idq = 425mA, Vm_{xr} = Vd_{bl} = -0.9V
 IF = 2GHz +/- 5MHz @ -8dBm Input/Tone, +2dBm LO

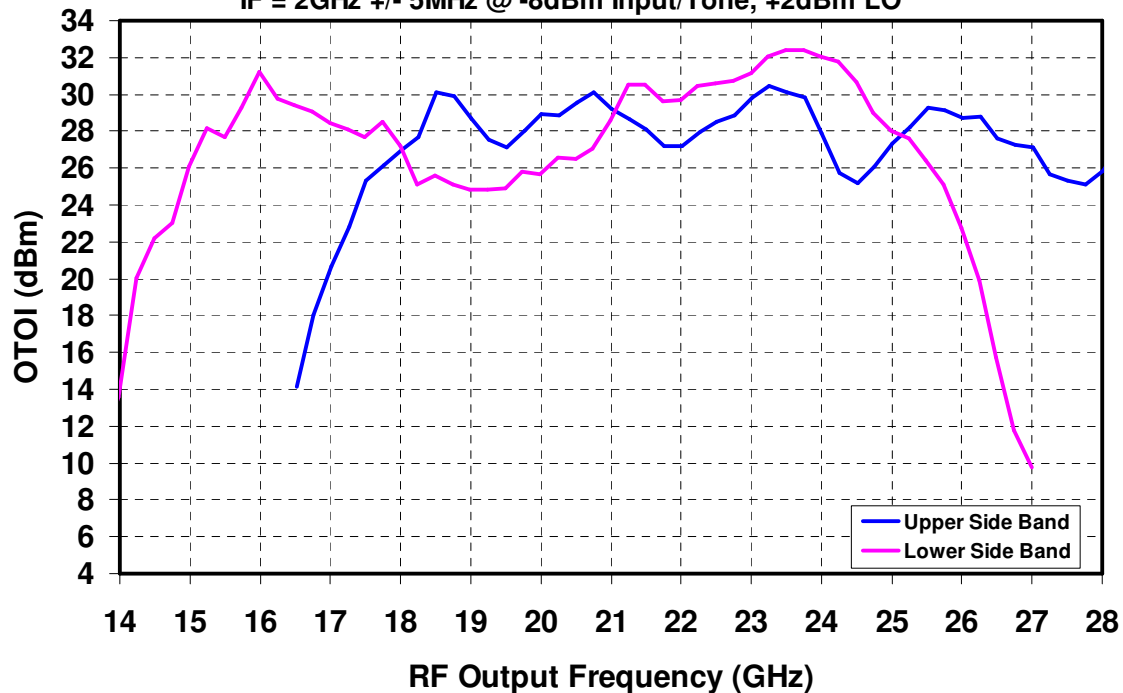

Measured Data

Vd = 5V, Idq = 425mA, Vmxr = Vdbl = -0.9V
IF = 2GHz @ -8dBm, +2dBm LO

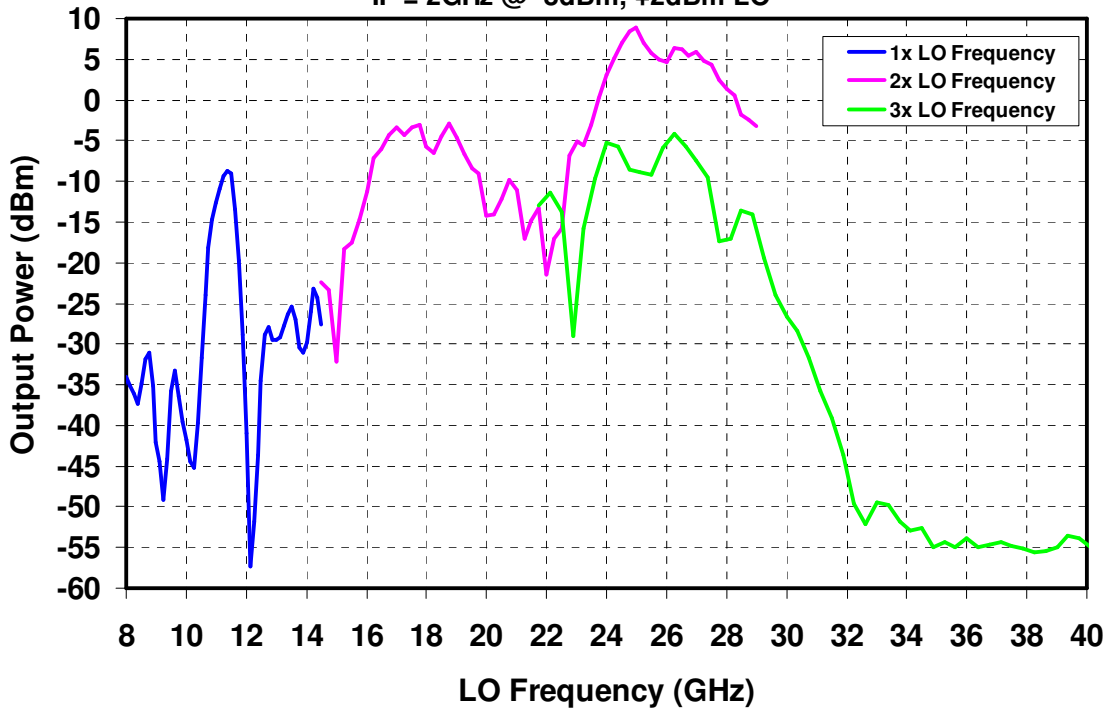

Measured Data

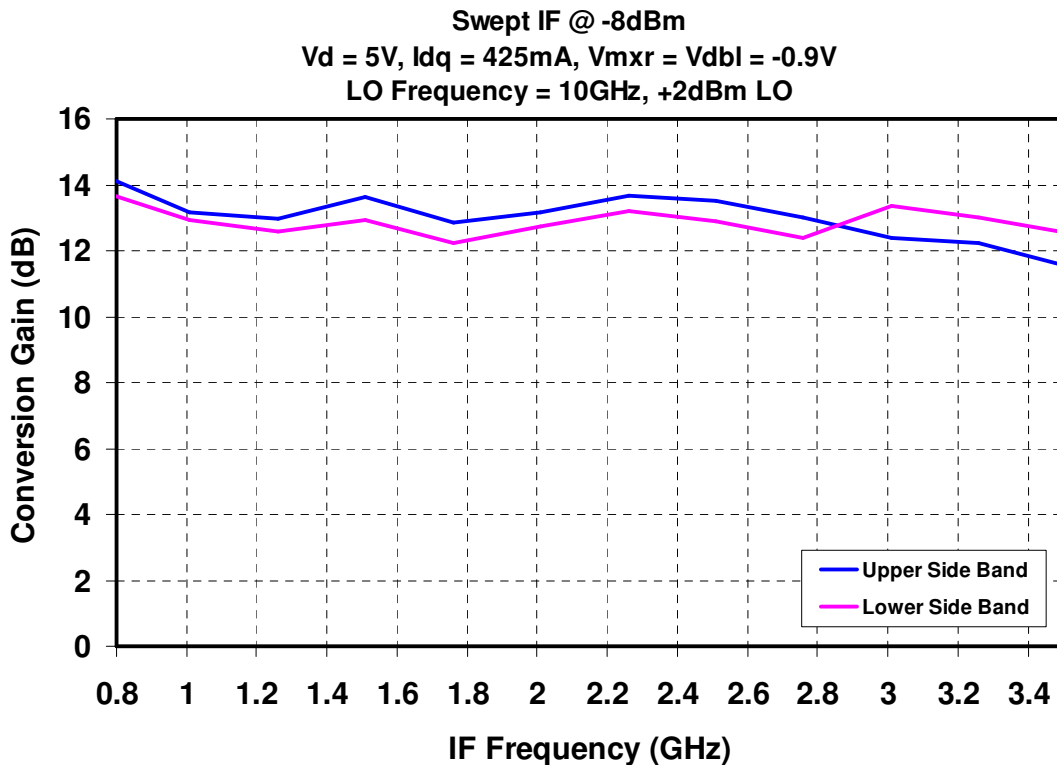
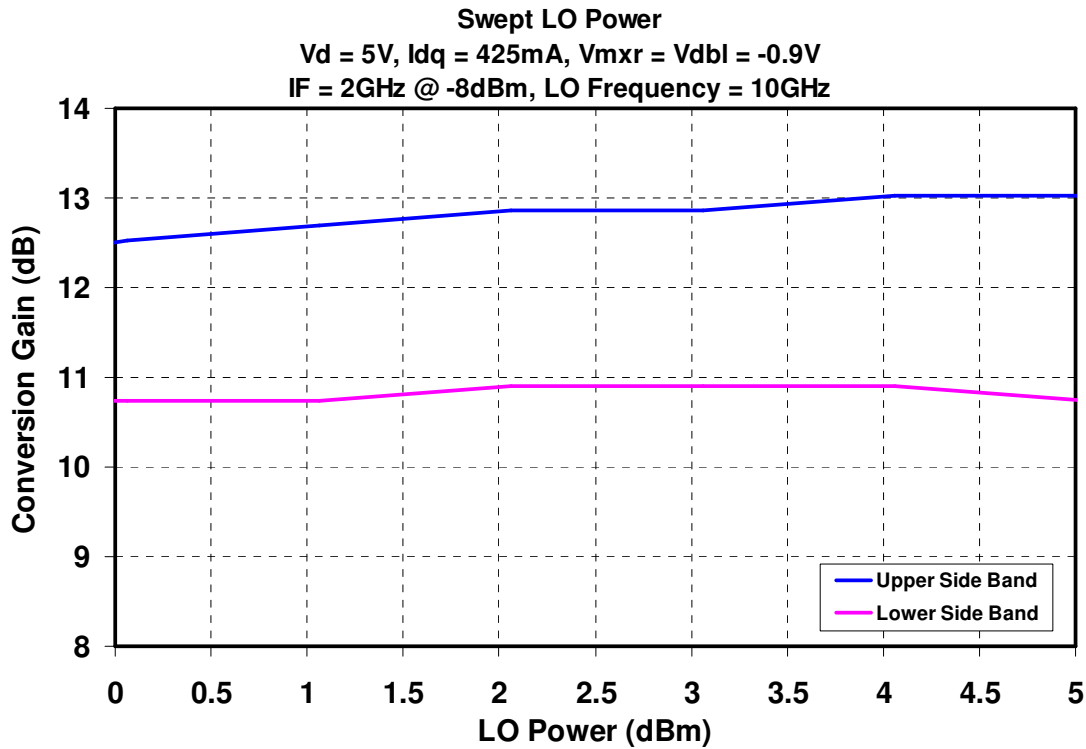

Measured Data

Vd = 5V vs. 4V, Idq = 425mA, Vmxr = Vdbl = -0.9V
 IF = 2GHz @ -5dBm, +2dBm LO

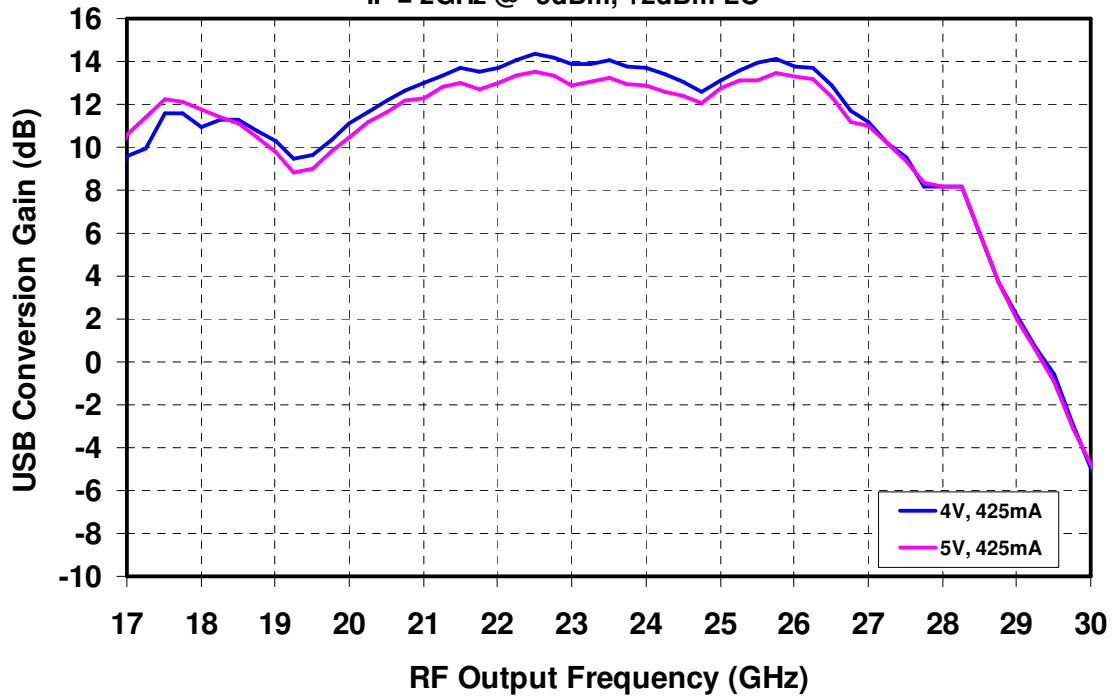

Vd = 5V vs. 4V, Idq = 425mA, Vmxr = Vdbl = -0.9V
 IF = 2GHz @ -5dBm, +2dBm LO

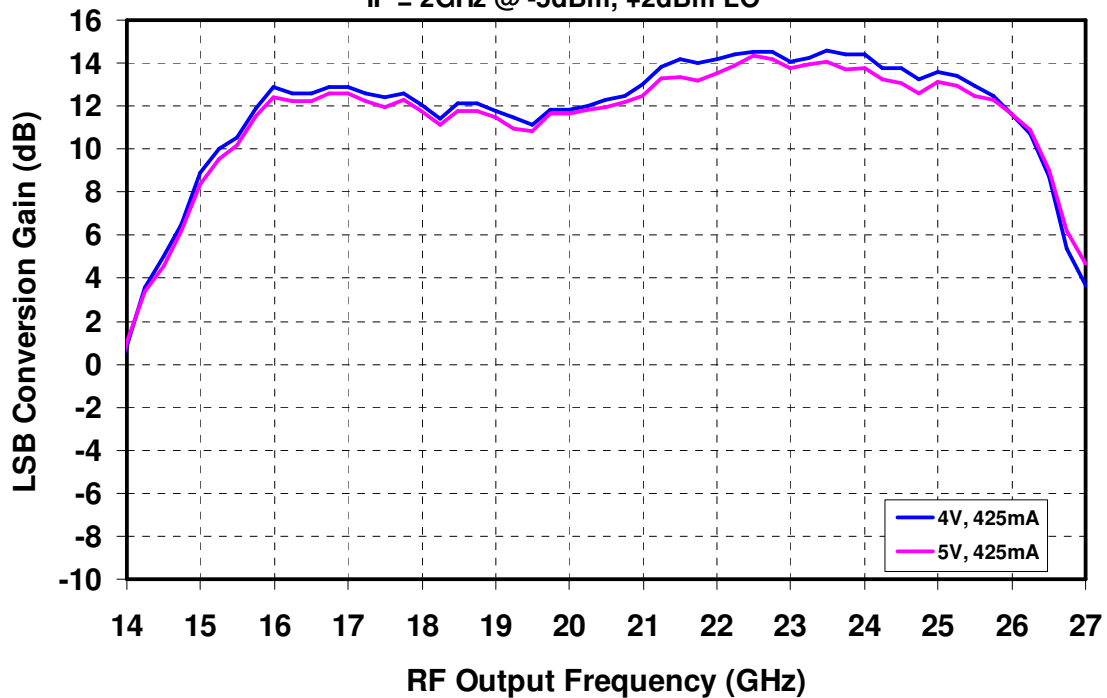

Measured Data

Vd = 5V vs. 4V, Idq = 425mA, Vmxr = Vdbl = -0.9V
 IF = 2GHz @ -5dBm, +2dBm LO

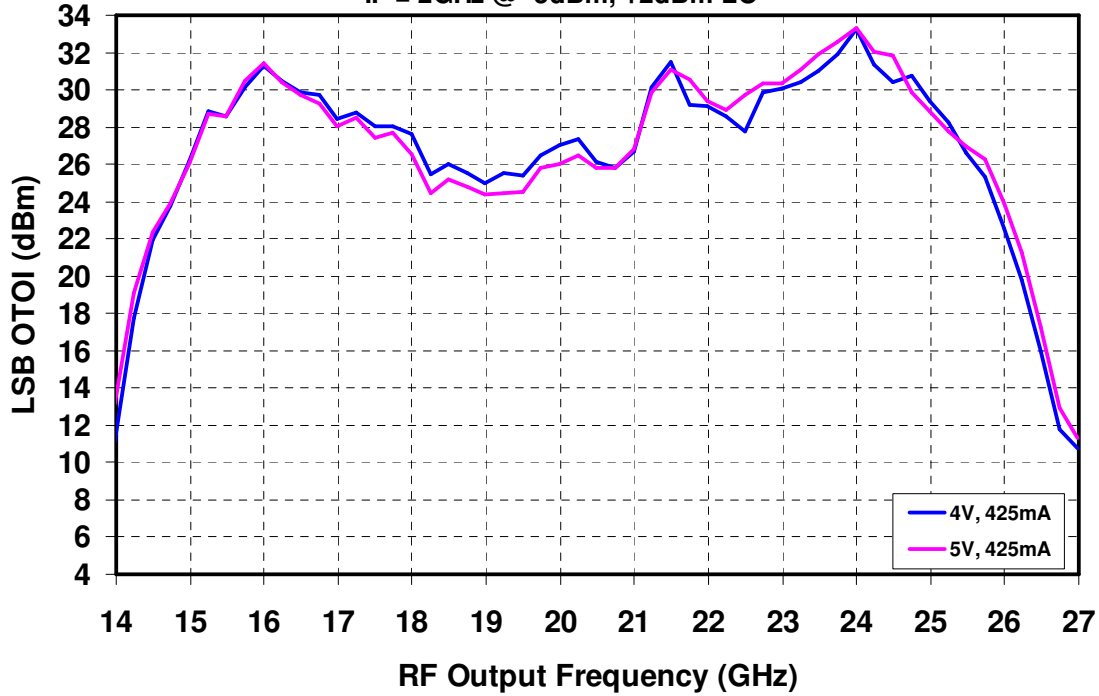

Vd = 5V vs. 4V, Idq = 425mA, Vmxr = Vdbl = -0.9V
 IF = 2GHz @ -5dBm, +2dBm LO

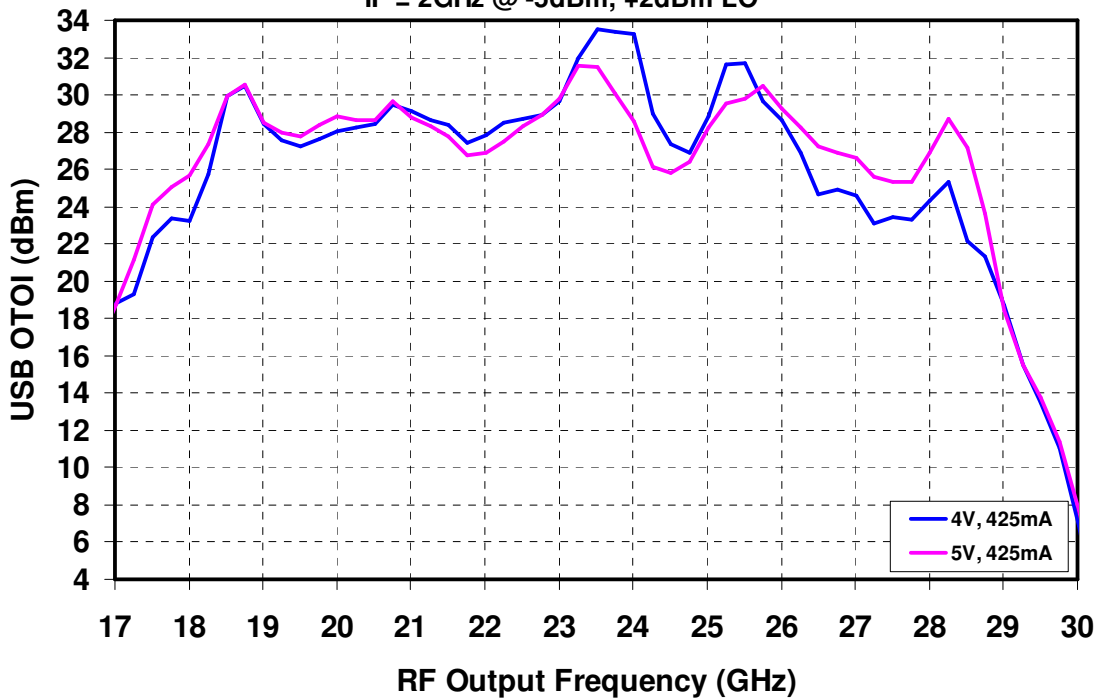

Measured Data

Vd = 5V, Idq = 425mA, Vm_{xr} = Vd_{bl} = -0.9V
 IF = 2GHz @ -5dBm, +2dBm LO

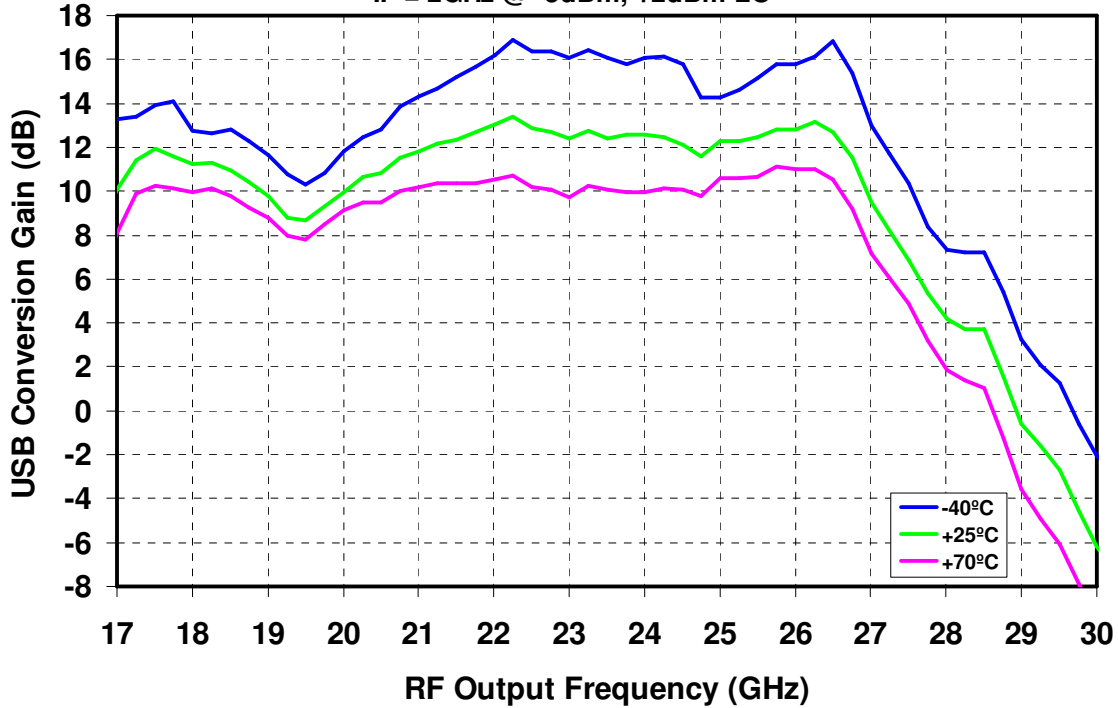

Vd = 5V, Idq = 425mA, Vm_{xr} = Vd_{bl} = -0.9V
 IF = 2GHz @ -5dBm, +2dBm LO

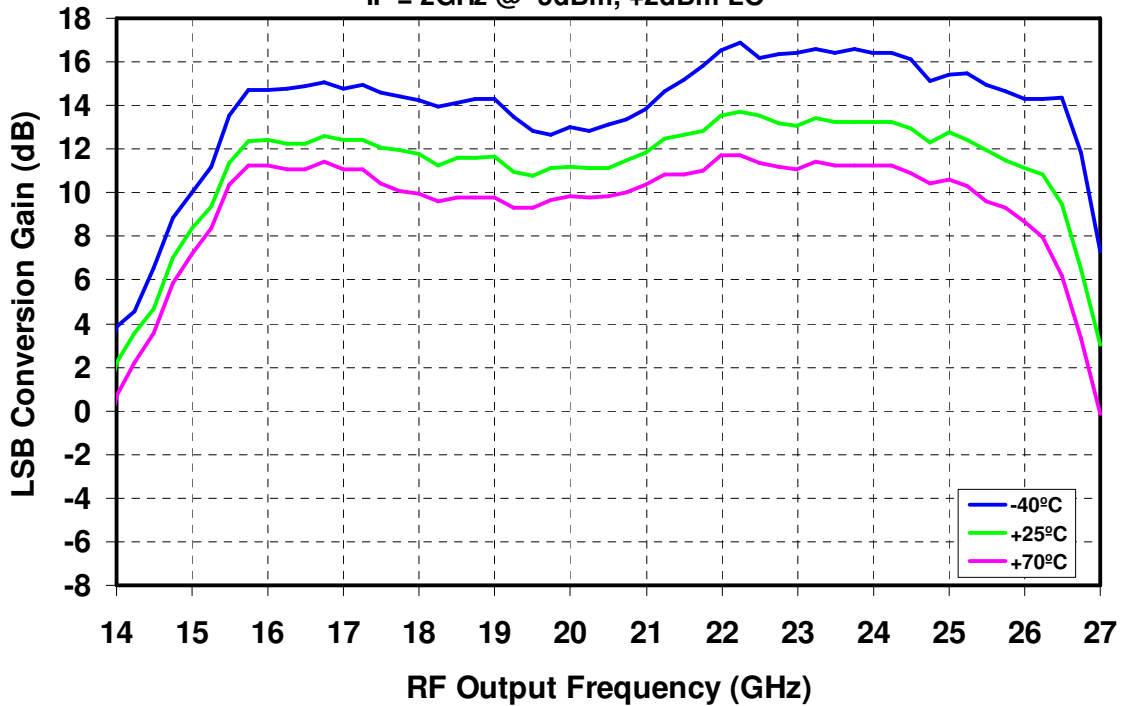

Electrical Schematic

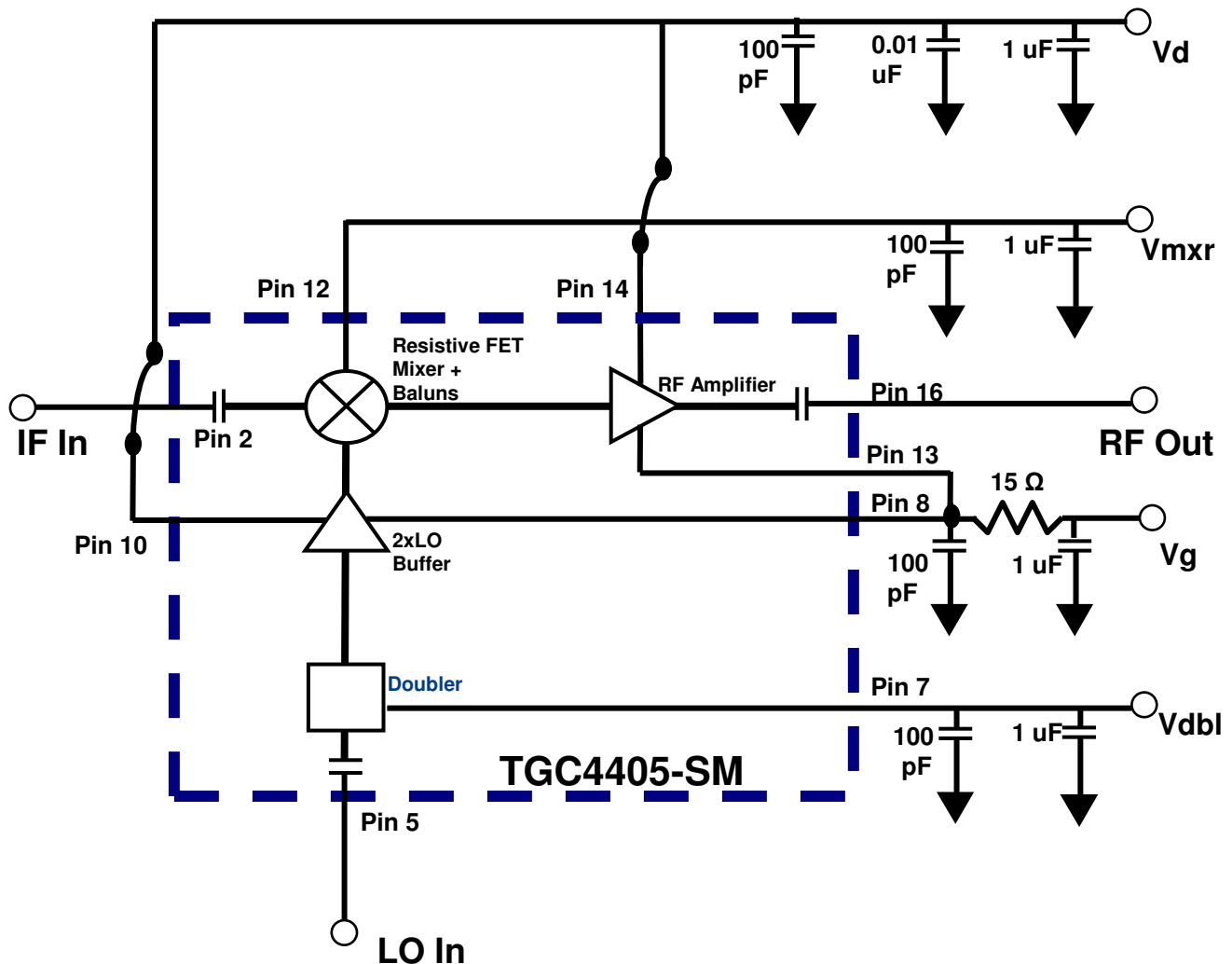

Bias Procedures

Bias-up Procedure

- Vg set to -1.5 V
- Vmxr set to -0.9V
- Vdbl set to -0.9 V
- Vd set to +5 V
- Adjust Vg more positive until Idq is 425 mA.
This will be ~ Vg = -0.5 V
- Apply signals to LO and IF input

Bias-down Procedure

- Turn off signals
- Turn Vd to 0V
- Turn Vdbl to 0V
- Turn Vmxr to 0V
- Turn Vg to 0V

Package Pinout

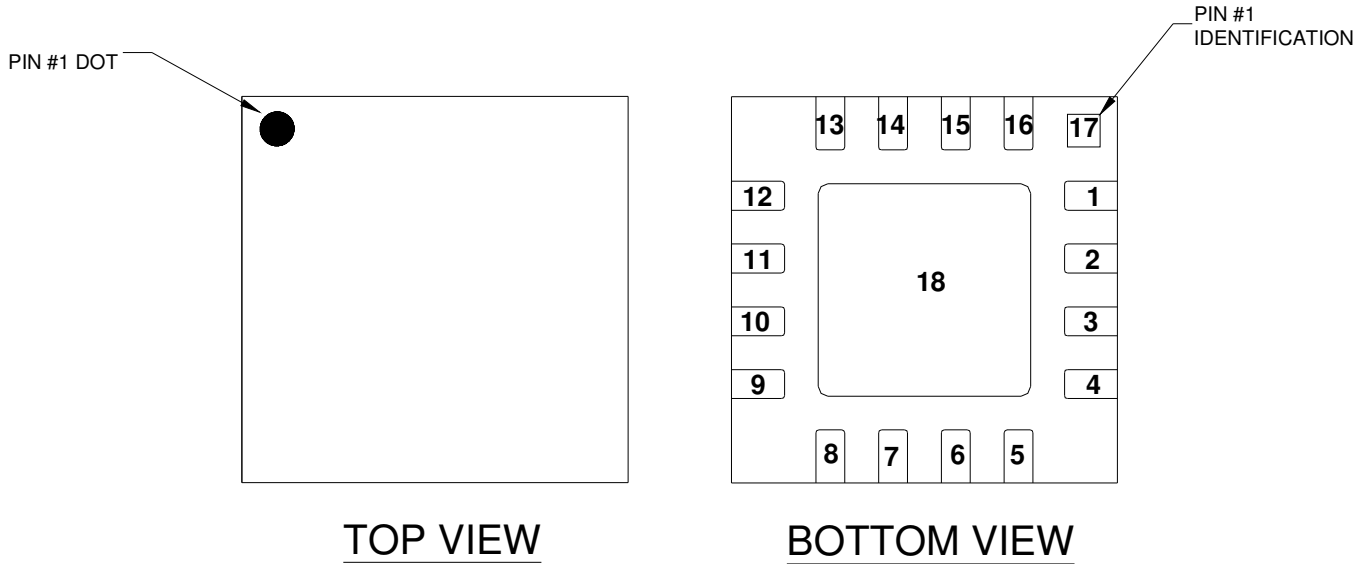

Pin	Description
1, 3, 4, 6, 9, 11, 15, 17, 18	Gnd
2	IF In
5	LO In
7	Vdbl
8, 13	Vg
10, 14	Vd
12	Vmxr
16	RF Out

Mechanical Drawing

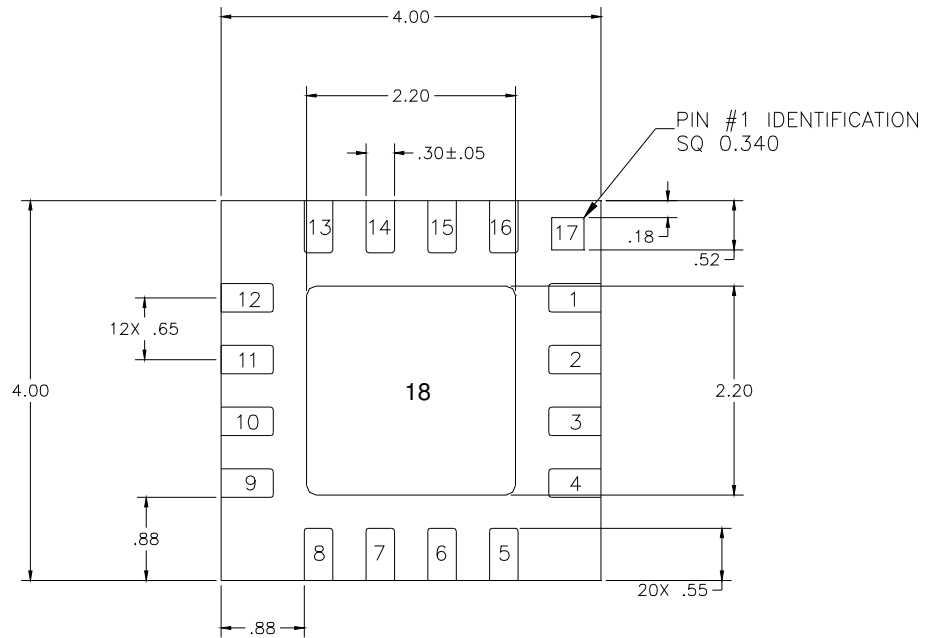

BOTTOM VIEW

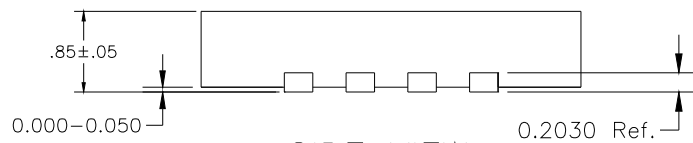

SIDE VIEW

Units: millimeters
 Thickness: 0.85
 Pkg x,y size tolerance: +/- 0.050

GaAs MMIC devices are susceptible to damage from Electrostatic Discharge. Proper precautions should be observed during handling, assembly and test.

Recommended Assembly Diagram

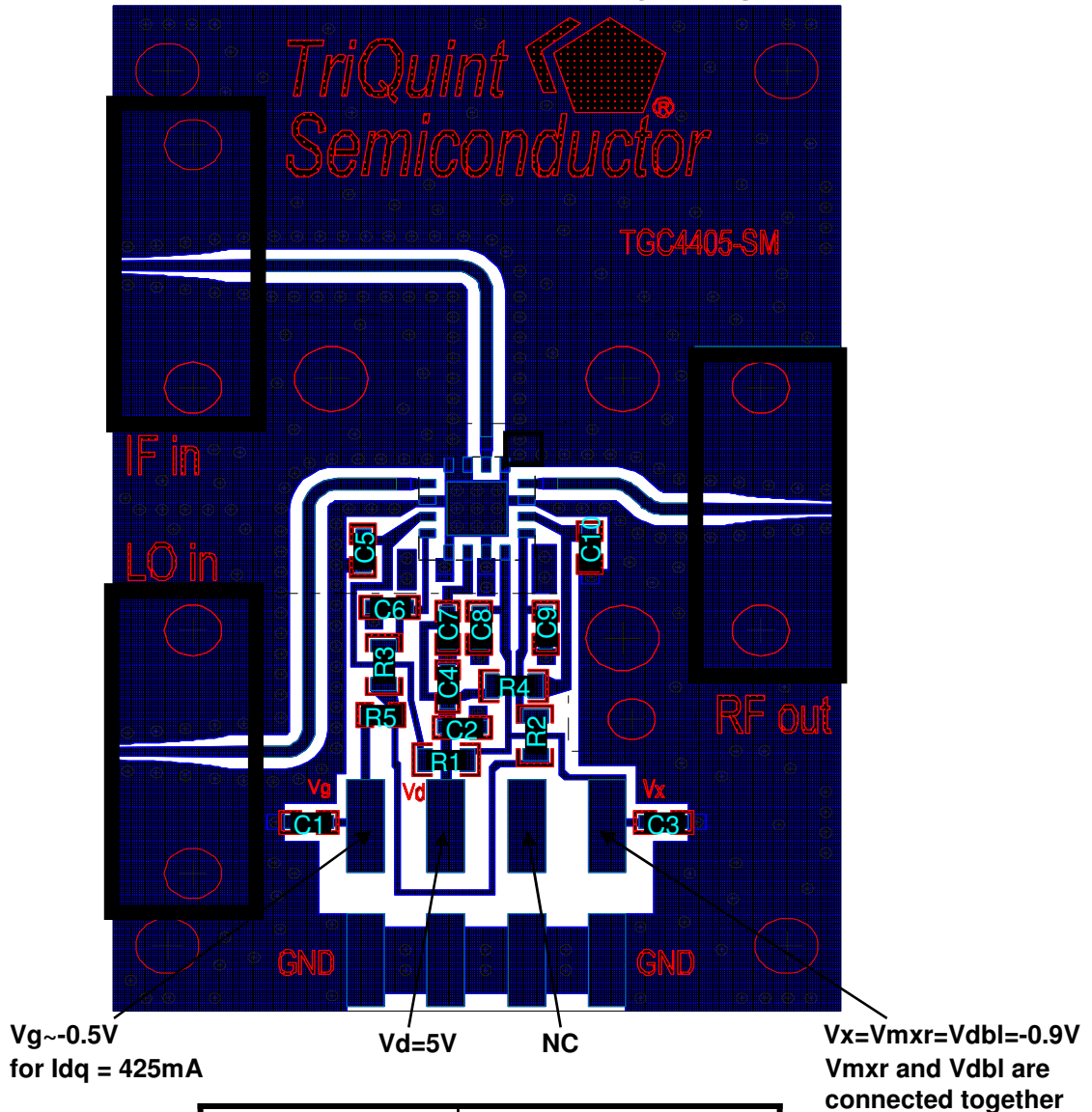

Part	Description
C1, C2, C3	1 uF Capacitor (0402)
C4	0.01 uF Capacitor (0402)
C5, C6, C7, C8, C9, C10	100 pF Capacitor (0402)
R1, R2, R3, R4	Jumper (0603)
R5	15 ohm Resistor (0402)

GaAs MMIC devices are susceptible to damage from Electrostatic Discharge. Proper precautions should be observed during handling, assembly and test.

Assembly Notes

Recommended Surface Mount Package Assembly

- Proper ESD precautions must be followed while handling packages.
- Clean the board with acetone. Rinse with alcohol. Allow the circuit to fully dry.
- TriQuint recommends using a conductive solder paste for attachment. Follow solder paste and reflow oven vendors' recommendations when developing a solder reflow profile. Typical solder reflow profiles are listed in the table below.
- Hand soldering is not recommended. Solder paste can be applied using a stencil printer or dot placement. The volume of solder paste depends on PCB and component layout and should be well controlled to ensure consistent mechanical and electrical performance.
- Clean the assembly with alcohol.

Typical Solder Reflow Profiles

Reflow Profile	SnPb	Pb Free
Ramp-up Rate	3 °C/sec	3 °C/sec
Activation Time and Temperature	60 – 120 sec @ 140 – 160 °C	60 – 180 sec @ 150 – 200 °C
Time above Melting Point	60 – 150 sec	60 – 150 sec
Max Peak Temperature	240 °C	260 °C
Time within 5 °C of Peak Temperature	10 – 20 sec	10 – 20 sec
Ramp-down Rate	4 – 6 °C/sec	4 – 6 °C/sec

Ordering Information

Part	Package Style
TGC4405-SM	QFN 4x4 Surface Mount

GaAs MMIC devices are susceptible to damage from Electrostatic Discharge. Proper precautions should be observed during handling, assembly and test.