

MFLHP Single and Dual DC/DC Converters

28 VOLT INPUT – 100 WATT

FEATURES

- -55° to +100°C operation
- 19 to 40 VDC input
- Fully Isolated
- Magnetic feedback
- Fixed frequency, 600 kHz typical
- Topology – Single Ended Forward
- 80 V for up to 50 ms transient protection
- Inhibit function – input and output
- Sync function – input and output
- Output trim on single output models
- Indefinite short circuit protection
- Remote sense on single output models
- Up to 87% efficiency
- Parallelable up to 228 watts



MODELS VDC OUTPUT	
SINGLE	DUAL
5	±5
12	±12
15	±15

DESCRIPTION

The MFLHP Series™ 28 volt DC/DC converters are rated up to 100 watts output power over a -55° to +100°C temperature range with a 28 VDC nominal input. On dual output models, up to 70% of the rated output power can be drawn from either the positive or negative outputs. Current sharing allows the units to be paralleled for total power of up to 228 watts. The welded, hermetically sealed package is only 3.005 x 1.505 x 0.400 inches, giving the series an overall power density of up to 67 watts per cubic inch.

DESIGN FEATURES

The MFLHP Series converters are switching regulators that use a quasi-square wave, single ended forward converter design with a constant switching frequency of 600 kHz.

Isolation between input and output circuits is provided with a transformer in the forward path and wide bandwidth magnetic coupling in the feedback control loop. The MFLHP Series uses a unique dual loop feedback technique that controls output current with an inner feedback loop and output voltage with a cascaded voltage mode feedback loop.

The additional secondary current mode feedback loop improves transient response in a manner similar to primary current mode control and allows for ease of paralleling.

Tight load regulation is achieved through a wide-bandwidth magnetic feedback circuit. The output voltage on single MFLHP models can be easily trimmed by adding an external resistor. (See Figure 1 for voltage changes with different resistor values.)

INHIBIT

The MFLHP Series converters have two inhibit terminals (INH1 and INH2) that can be used to disable power conversion,

resulting in a very low quiescent input current. A logic low (<0.8 volts) is required between INH1 (pin 4) and Input Common (pin 2) to inhibit the converter. A logic low (<0.5 volts) is required between INH2 (pin 12) and Output Common (pin 8) to inhibit the converter. The application of intermediate voltages to these pins (1.5 to 10.5 volts) should be avoided.

SYNC

Converters may be synced to an external clock (525 to 675 kHz) or to one another by using the sync in or out pins. The nominal free-run switching frequency is 600 kHz.

CURRENT SHARING AND PARALLEL OPERATION

Multiple MFLHP converters may be used in parallel to drive a common load (see Figure 3). In this mode of operation the load current is shared by two or three MFLHP converters. In current sharing mode, one MFLHP converter is designated as a master. The SLAVE pin (pin 11) of the master is left unconnected and the MSTR/INH2 pin (pin 12) of the master is connected to the SLAVE pin (pin 11) of the slave units. The units designated as slaves have the MSTR/INH2 pin (pin 12) connected to the SNS RTN pin (pin 9). Figure 3 shows the typical setup for two or three units in parallel. Note that synchronizing the units together (though shown in the figure) is not required for current sharing operation. A second slave unit may be placed in parallel with a master and slave; this requires the TRI pin (pin 3) of the master unit to be connected to the SNS RTN pin (pin 9).

When paralleled, 76% of the total combined power ratings of the MFLHP converters are available at the load. Overload and short circuit performance are not adversely affected during parallel operation.

MFLHP Single and Dual DC/DC Converters

28 VOLT INPUT – 100 WATT

OPERATING CONDITIONS AND CHARACTERISTICS

Input Voltage Range

- 19 to 40 VDC continuous
- 80 V for 50 msec transient

Output Power

- 80 to 100 watts depending on model

Lead Soldering Temperature (10 sec per pin)

- 300°C

Storage Temperature Range (Case)

- -65°C to +150°C

Power Dissipation (Pd) Max

- 20 watts

Case Operating Temperature (Tc)

- -55 to +100°C full power
- -55 to +135°C absolute

Derating Output Power/Current

- Linearly from 100% at 100°C to 0% at 135°C

Output Voltage Temperature Coefficient

- 100 ppm/°C typical

Input to Output Capacitance

- 150 pF typical

Current Limit

- 115% of full load typical

Isolation

- 100 megohm minimum at 500 VDC

Audio Rejection

- 50 dB typical

Conversion Frequency

- Free run mode 600 kHz typical
550 kHz min, 650 kHz. max
- External sync range 525 to 675 kHz

Inhibit Pin Voltage (unit enabled)

- INH1 = 9 to 12 V, INH2 = 6 to 9 V

SYNC IN AND INHIBIT (INH1, INH2)

Sync In (525 to 675 kHz)

- Duty cycle 40% min, 60% max
- Logic low 0.8 V max
- Logic high 4.5 V min
- Referenced to input common

Sync Out - Referenced to input common

Inhibit (INH1, INH2) TTL Open Collector

- Logic low (output disabled)
Current -10 to -5 mA
INH1 referenced to input common
Logic low 0.8 V max
INH2 referenced to output common
Logic low 0.5 V max
- Logic high (output enabled)
Open collector

MECHANICAL AND ENVIRONMENTAL

Size (maximum)

3.005 x 1.505 x 0.400 inches (76.33 x 38.23 x 10.16 mm)
See case U for dimensions.

Weight (maximum)

100 grams

Screening

Standard or ES. See "100°C Non-QML Products—MIL-PRF-38534 Environmental Screening" for more information.

MFLHP Single and Dual DC/DC Converters

28 VOLT INPUT – 100 WATT

PIN OUT

Pin	Single Output	Dual Output
1	Positive Input	Positive Input
2	Input Common	Input Common
3	Triple (TRI)	Triple (TRI)
4	Inhibit 1 (INH1)	Inhibit 1 (INH1)
5	Sync Out	Sync Out
6	Sync In	Sync In
7	Positive Output	Positive Output
8	Output Common	Output Common
9	Sense Return	Negative Output
10	Positive Sense	No connection
11	Slave	Slave
12	Master / Inhibit 2 (MSTR/INH2)	Master / Inhibit 2 (MSTR/INH2)

PINS NOT IN USE

TR1	Leave unconnected
Master	Leave unconnected
Slave	Leave unconnected
Sync in	Connect to input common
Inhibit (INH1)	Leave unconnected
Inhibit (INH2)	Leave unconnected
Sync Out	Leave unconnected
Sense Lines	Must be connected to appropriate outputs

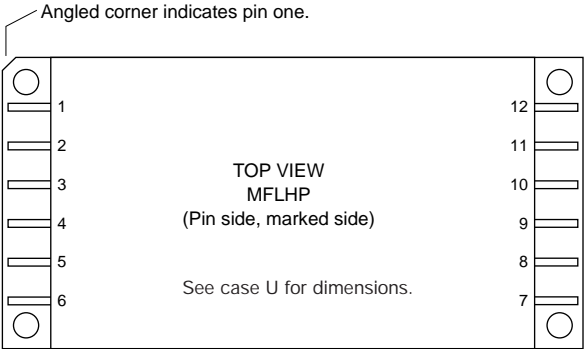

FIGURE 1: PIN OUT

MFLHP Single and Dual DC/DC Converters

28 VOLT INPUT – 100 WATT

SINGLE OUTPUT MODELS CONNECTION DIAGRAMS - SENSE AND PARALLEL

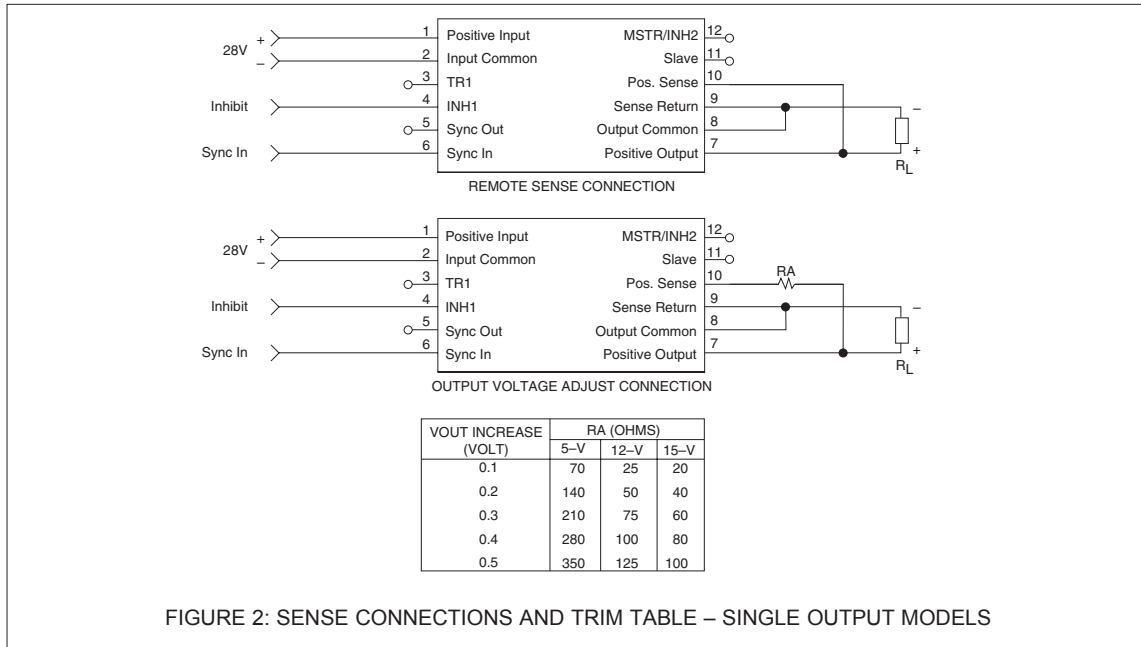

FIGURE 2: SENSE CONNECTIONS AND TRIM TABLE – SINGLE OUTPUT MODELS

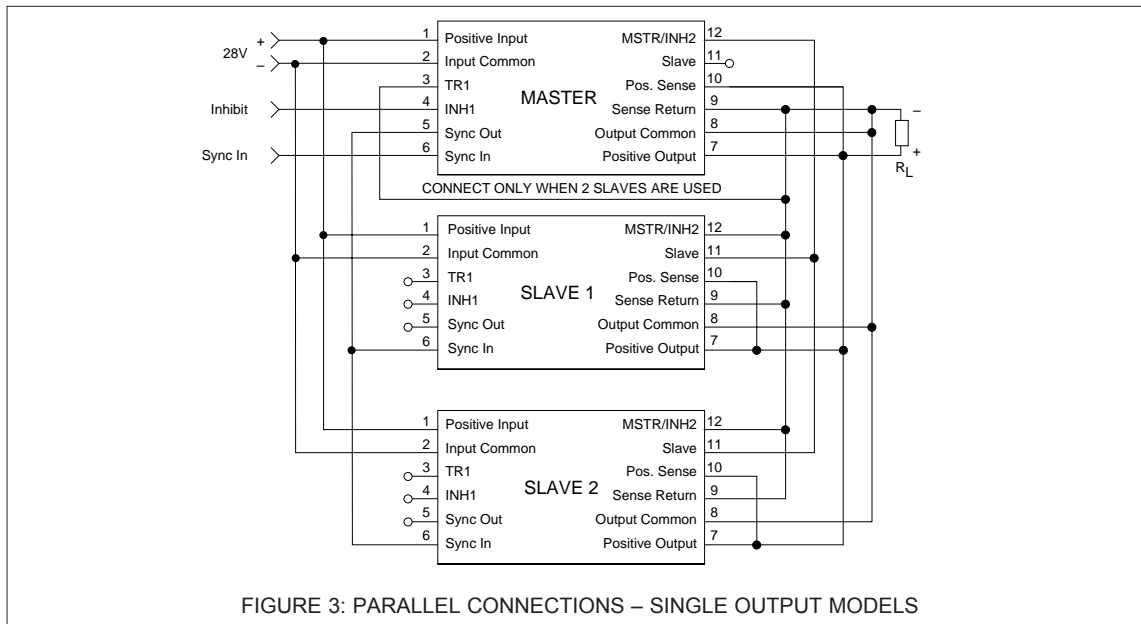
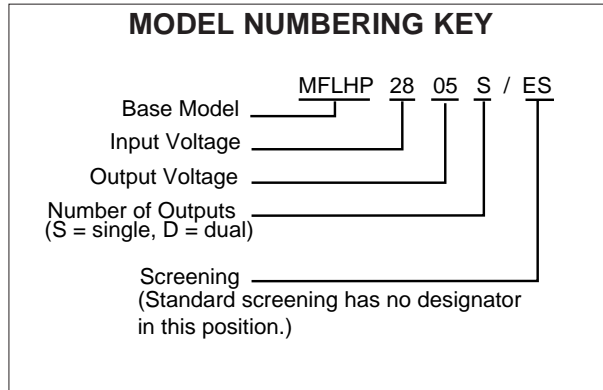

FIGURE 3: PARALLEL CONNECTIONS – SINGLE OUTPUT MODELS

MFLHP Single and Dual DC/DC Converters

28 VOLT INPUT – 100 WATT



MODEL SELECTION

MFLHP28 /
Base model *V_{out} value* *number of outputs* *screening*

Choose one from each of the following rows:

V_{out} value for singles and duals: 5, 12, 15

Number of outputs S (single) or D (dual)

Screening standard screening, leave blank /ES (ES screening)

MFLHP Single and Dual DC/DC Converters

28 VOLT INPUT – 100 WATT

Electrical Characteristics: -55°C to +100°C Tc, 28 VDC Vin, 100% load, free run, unless otherwise specified.

SINGLE OUTPUT MODELS		MFLHP2805S			MFLHP2812S			MFLHP2815S			UNITS
PARAMETER	CONDITIONS	MIN	TYP	MAX	MIN	TYP	MAX	MIN	TYP	MAX	
OUTPUT VOLTAGE	TC = 25°C	4.95	5.00	5.05	11.88	12.00	12.12	14.85	15.00	15.15	VDC
OUTPUT CURRENT	V _{IN} = 19 TO 40 VDC	0	—	16	0	—	7.5	0	—	6.67	A
OUTPUT POWER	V _{IN} = 19 TO 40 VDC	0	—	80	0	—	90	0	—	100	W
OUTPUT RIPPLE 10 kHz - 2 MHz	TC = 25°C	—	15	35	—	30	75	—	30	85	mV p-p
	TC = -55°C TO +100°C	—	30	75	—	45	125	—	45	150	
LINE REGULATION	V _{IN} = 19 TO 40 VDC	—	0	20	—	0	20	—	0	20	mV
LOAD REGULATION	NO LOAD TO FULL	—	0	20	—	0	20	—	0	20	mV
INPUT VOLTAGE NO LOAD TO FULL	CONTINUOUS	19	28	40	19	28	40	19	28	40	VDC
	TRANSIENT ² 50 msec. ¹	—	—	80	—	—	80	—	—	80	V
INPUT CURRENT	NO LOAD	—	70	120	—	50	120	—	50	120	mA
	INHIBITED-INH1	—	9	14	—	9	14	—	9	14	
	INHIBITED-INH2	—	35	70	—	35	70	—	35	70	
INPUT RIPPLE CURRENT	10 kHz - 10 MHz	—	15	50	—	15	50	—	15	50	mA p-p
EFFICIENCY	TC = 25°C	78	80	—	83	86	—	84	87	—	%
LOAD FAULT TC = 25°C	POWER DISSIPATION SHORT CIRCUIT	—	15	20	—	15	20	—	15	20	W
	RECOVERY ¹	—	1.5	4	—	1.5	4	—	1.5	4	m sec
STEP LOAD RESPONSE	50% - 100% - 50% TRANSIENT	—	350	450	—	450	700	—	450	700	mV pk
	RECOVERY ³	—	1.5	3.0	—	1.5	3.0	—	1.5	3.0	m sec
STEP LINE RESPONSE	19 - 40 -19 VDC TRANSIENT ^{1, 4}	—	250	400	—	250	400	—	250	400	mV pk
	RECOVERY ^{1, 3}	—	200	300	—	200	300	—	200	300	μs
START-UP	DELAY	—	3.5	6	—	3.5	6	—	3.5	6	m sec
	OVERSHOOT ¹	—	0	25	—	0	50	—	0	50	mV pk

Notes:

1. Guaranteed by design, not tested.
2. Unit will shut down above approximately 45V but will be undamaged and will restart when voltage drops into normal range.

3. Recovery time is measured from application of the transient to point at which V_{out} is within 1% of final value.
4. Transition time ≥ 10 μs.

MFLHP Single and Dual DC/DC Converters

28 VOLT INPUT – 100 WATT

Electrical Characteristics: -50°C to +100°C Tc, 28 VDC Vin, 100% load, free run, unless otherwise specified.

DUAL OUTPUT MODELS ⁸		MFLHP2805D			MFLHP2812D			MFLHP2815D			UNITS		
PARAMETER	CONDITIONS	MIN	TYP	MAX	MIN	TYP	MAX	MIN	TYP	MAX			
OUTPUT VOLTAGE	TC = 25°C	+ V _{OUT}		4.95	5.00	5.05	11.88	12.00	12.12	14.85	15.00	15.15	VDC
		- V _{OUT}		4.92	5.00	5.08	11.82	12.00	12.18	14.77	15.00	15.23	
OUTPUT CURRENT ² V _{IN} = 19 TO 40 VDC	EACH OUTPUT		0	—	11.2	0	—	5.3	0	—	4.67	A	
	TOTAL OUTPUT		0	—	16.0	0	—	7.5	0	—	6.67		
OUTPUT POWER ² V _{IN} = 19 TO 40 VDC	EACH OUTPUT		0	—	56	0	—	63	0	—	70	W	
	TOTAL OUTPUT		0	—	80	0	—	90	0	—	100		
OUTPUT RIPPLE ± V _{OUT}	10 kHz - 2 MHz		—	25	125	—	50	150	—	50	200	mV p-p	
LINE REGULATION V _{IN} = 19 TO 40 VDC	+ V _{OUT}		—	0	50	—	0	50	—	0	50	mV	
	- V _{OUT}		—	25	100	—	25	100	—	25	100		
LOAD REGULATION NO LOAD TO FULL	+ V _{OUT}		—	0	50	—	10	100	—	10	100	mV	
	- V _{OUT}		—	25	100	—	50	200	—	50	200		
CROSS REGULATION TC = 25°C	SEE NOTE 3		—	6	8	—	2	4	—	2	4	%	
	SEE NOTE 4		—	7	8	—	2	4	—	2	4		
INPUT VOLTAGE NO LOAD TO FULL	CONTINUOUS		19	28	40	19	28	40	19	28	40	VDC	
	TRANSIENT 50 msec. ^{1, 5}		0	—	80	0	—	80	0	—	80	V	
INPUT CURRENT TC = 25°C	NO LOAD		—	50	120	—	50	100	—	50	100	mA	
	INHIBITED-INH1		—	9	14	—	9	14	—	9	14		
	INHIBITED-INH2		—	35	70	—	35	70	—	35	70		
INPUT RIPPLE CURRENT	10 kHz - 10 MHz		—	15	50	—	15	50	—	15	50	mA p-p	
EFFICIENCY TC = 25°C	BALANCED LOAD		78	80	—	83	86	—	84	87	—	%	
LOAD FAULT TC = 25°C	POWER DISSIPATION SHORT CIRCUIT		—	15	20	—	15	20	—	15	20	W	
	RECOVERY ¹		—	1.5	4.0	—	1.5	4.0	—	1.5	4.0	m sec	
STEP LOAD RESPONSE ± V _{OUT}	50% - 100% - 50% TRANSIENT		—	350	450	—	450	700	—	450	700	mV pk	
	RECOVERY ⁶		—	1.5	3.0	—	1.5	3.0	—	1.5	3.0	msec	
STEP LINE RESPONSE ± V _{OUT}	19 - 40 -19 VDC TRANSIENT ^{1, 7}		—	250	400	—	250	400	—	250	400	mV pk	
	RECOVERY ^{1, 6}		—	200	300	—	200	300	—	200	300	μs	
START-UP ⁸	DELAY		—	3.5	6	—	3.5	6	—	3.5	6	m sec	
	OVERSHOOT ¹		—	0	25	—	0	50	—	0	50	mV pk	

Notes:

- Guaranteed by design, not tested.
- Up to 70% of the total output power is available from either output providing the opposite output is simultaneously carrying 30% of the total power.
- Effect on negative V_{out} from 50%/50% loads to 30%/70% or 70%/30% loads.
- Effect on negative V_{out} from 50%/50% loads to 10% then 50% load on negative V_{out}.

- Unit will shut down above approximately 45V but will be undamaged and will restart when voltage drops into normal range.
- Recovery time is measured from application of the transient to point at which V_{out} is within 1% of final value.
- Transition time ≥ 10 μs.
- Parallel/current share operation is not characterized for dual output models.

MFLHP Single and Dual DC/DC Converters

28 VOLT INPUT – 100 WATT

Typical Performance Curves: 25°C Tc, 28 VDC Vin, 100% load, free run, unless otherwise specified.

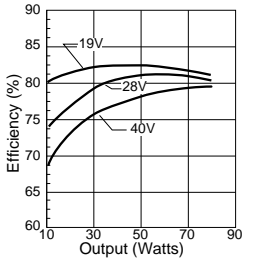

MFLHP2805S & MFLHP2805D Efficiency

FIGURE 4

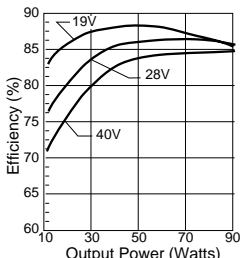

MFLHP2812S & MFLHP2812D Efficiency

FIGURE 5

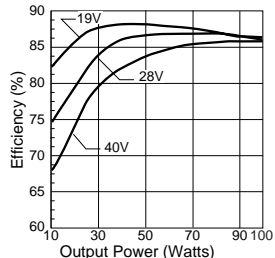

MFLHP2815S & MFLHP2815D Efficiency

FIGURE 6

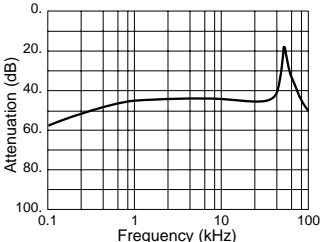

MFLHP Series Audio Rejection

FIGURE 7

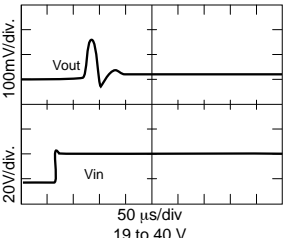

MFLHP2805S Step Line Response

FIGURE 8

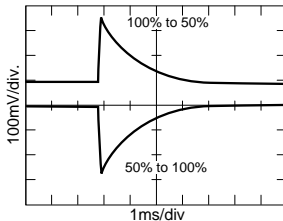

MFLHP2805S Step Load Response

FIGURE 9

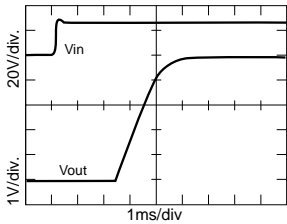

MFLHP2805S Turn On Response

FIGURE 10

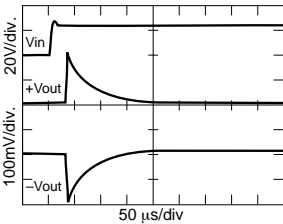

MFLHP2815D Step Line Response

FIGURE 11

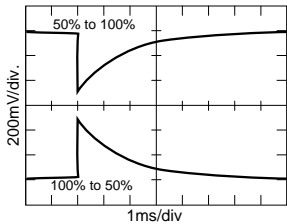

MFLHP2815D Step Load Response

FIGURE 12

MFLHP Single and Dual DC/DC Converters

28 VOLT INPUT – 100 WATT

Typical Performance Curves: 25°C Tc, 28 VDC Vin, 100% load, free run, unless otherwise specified.

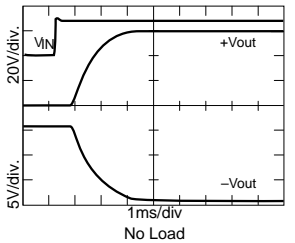

FIGURE 13

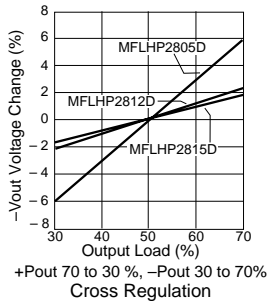

FIGURE 14

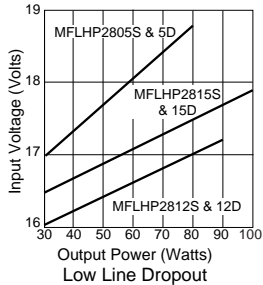

FIGURE 15

MFLHP Single and Dual DC/DC Converter Cases

28 VOLT INPUT – 100 WATT

TOP VIEW CASE U Flanged case, short-leaded

*Case U does not require designator in Case Option position of model number.

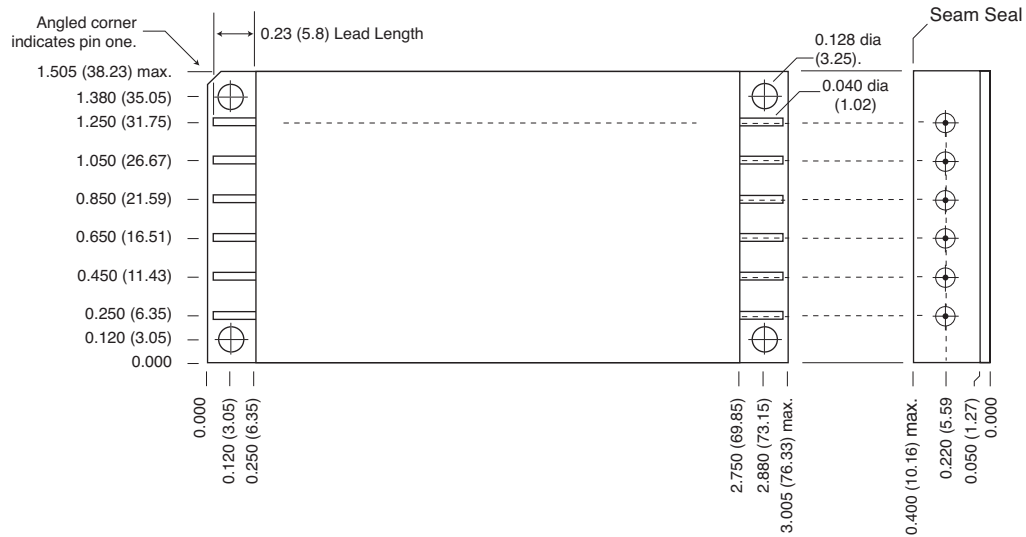

Case dimensions in inches (mm)

Tolerance ± 0.005 (0.13) for three decimal places
 ± 0.01 (0.3) for two decimal places
 unless otherwise specified

CAUTION

Heat from reflow or wave soldering may damage the device.
 Solder pins individually with heat application not exceeding 300°C for 10 seconds per pin

Materials

Header Cold Rolled Steel/Nickel/Gold
 Cover Kovar/Nickel
 Pins #52 alloy/Nickel/Gold; compression glass seal

Case U, Rev C, 20060302

Please refer to the numerical dimensions for accuracy. All information is believed to be accurate, but no responsibility is assumed for errors or omissions. Interpoint reserves the right to make changes in products or specifications without notice.

Copyright © 1999-2006 Interpoint Corp. All rights reserved.

FIGURE 16: CASE U

MFLHP Single and Dual DC/DC Converters

28 VOLT INPUT – 100 WATT

100°C NON-QML PRODUCTS, MIL-PRF-38534 ENVIRONMENTAL SCREENING

TEST PERFORMED	100°C STANDARD NON-QML ¹	100°C /ES NON-QML ¹
Pre-cap Inspection Method 2017, 2032	yes	yes
Temperature Cycle (10 times) Method 1010, Cond. B, -55°C to 125°C, ambient	no	yes
Constant Acceleration Method 2001, 500 g	no	yes
Burn-in 96 hours, typical case temperature 100°C case ²	no	yes
Final Electrical Test MIL-PRF-38534, Group A Subgroups 1 and 4: +25°C case	yes	yes
Hermeticity test Fine Leak, Method 1014, Cond. A Gross Leak, Method 1014, Cond. C Gross Leak, Dip (1 x 10 ⁻³)	no no yes	yes yes no
Final visual inspection Method 2009	yes	yes

Test methods are referenced to MIL-STD-883 as determined by MIL-PRF-38534.

Notes:

1. Non-QML products do not meet all of the requirements of MIL-PRF-38534
2. Burn-in is still air with an ambient temperature designed to bring the case temperature to 100°C