

Silicon PNP Power Transistors

2SA473

DESCRIPTION

- With TO-220 package
- Complement to type 2SC1173
- Collector current : $I_C = -3A$
- Collector dissipation: $P_C = 10W @ T_C = 25^\circ C$

APPLICATIONS

- Low frequency power amplifier
- Power regulator

PINNING

PIN	DESCRIPTION
1	Emitter
2	Collector; connected to mounting base
3	Base

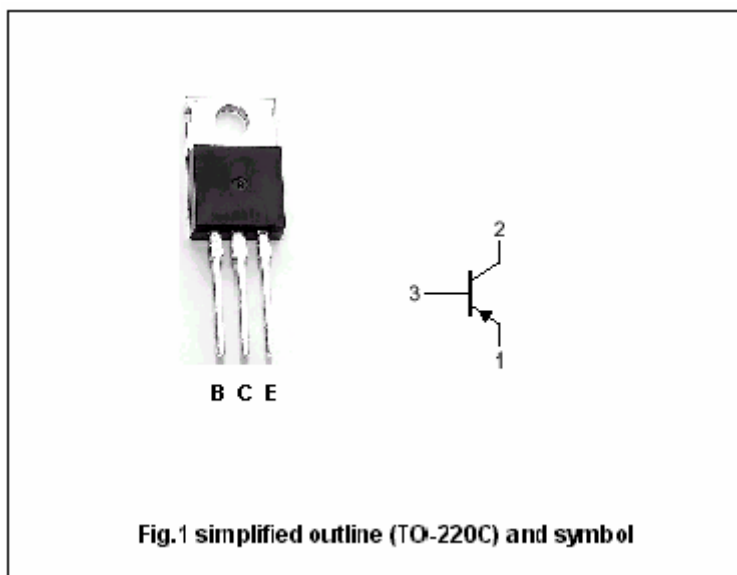
Absolute maximum ratings ($T_a = 25^\circ C$)

SYMBOL	PARAMETER	CONDITIONS	VALUE	UNIT
V_{CBO}	Collector-base voltage	Open emitter	-30	V
V_{CEO}	Collector-emitter voltage	Open base	-30	V
V_{EBO}	Emitter-base voltage	Open collector	-5	V
I_C	Collector current (DC)		-3	A
P_C	Collector power dissipation	$T_C = 25^\circ C$	10	W
T_j	Junction temperature		150	$^\circ C$
T_{stg}	Storage temperature		-55~150	$^\circ C$

Silicon PNP Power Transistors

2SA473

CHARACTERISTICS

T_j=25°C unless otherwise specified

SYMBOL	PARAMETER	CONDITIONS	MIN	TYP.	MAX	UNIT
V _{(BR)CEO}	Collector-emitter breakdown voltage	I _C =-10mA ; I _B =0	-30			V
V _{(BR)CBO}	Collector-base breakdown voltage	I _C =-0.5mA ; I _E =0	-30			V
V _{(BR)EBO}	Emitter-base breakdown voltage	I _E =-1mA ; I _C =0	-5			V
V _{CEsat}	Collector-emitter saturation voltage	I _C =-2A; I _B =-0.2A			-0.8	V
V _{BE}	Base-emitter voltage	I _C =-0.5A ; V _{CE} =-2V			-1.0	V
I _{CBO}	Collector cut-off current	V _{CB} =-20V; I _E =0			-1.0	μ A
I _{EBO}	Emitter cut-off current	V _{EB} =-5V; I _C =0			-1.0	μ A
h _{FE-1}	DC current gain	I _C =-0.5A ; V _{CE} =-2V	70		240	
h _{FE-2}	DC current gain	I _C =-2.5A ; V _{CE} =-2V	25			
C _{OB}	Output capacitance	I _E =0; V _{CB} =-10V; f=1MHz		40		pF
f _T	Transition frequency	I _C =-0.5A ; V _{CE} =-2V		100		MHz

◆ h_{FE-1} classifications

O	Y
70-140	120-240

Silicon PNP Power Transistors

2SA473

PACKAGE OUTLINE

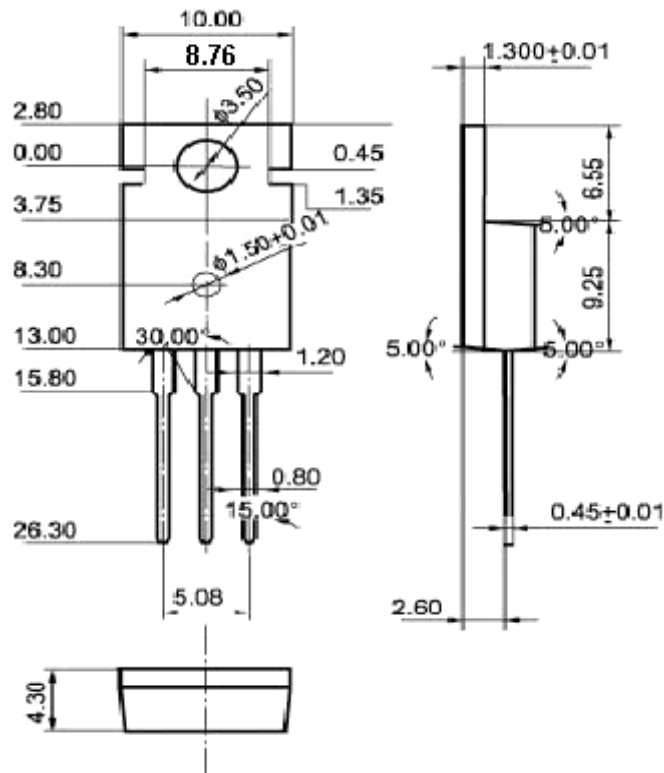

Fig.2 outline dimensions (unindicated tolerance: ± 0.10 mm)

Silicon PNP Power Transistors

2SA473

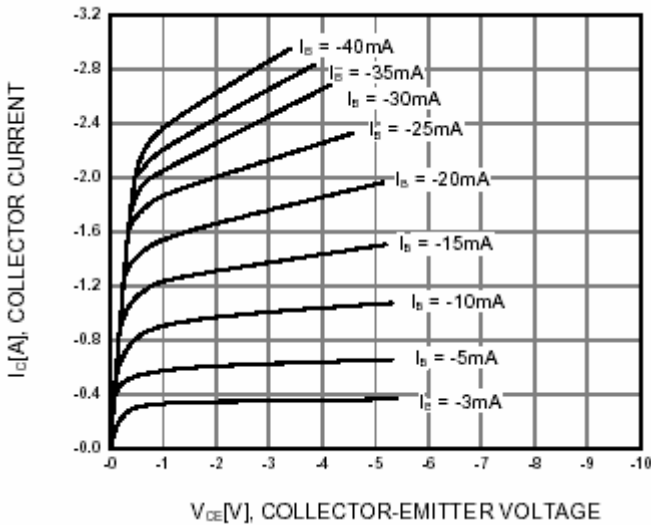

Fig.3 Static Characteristic

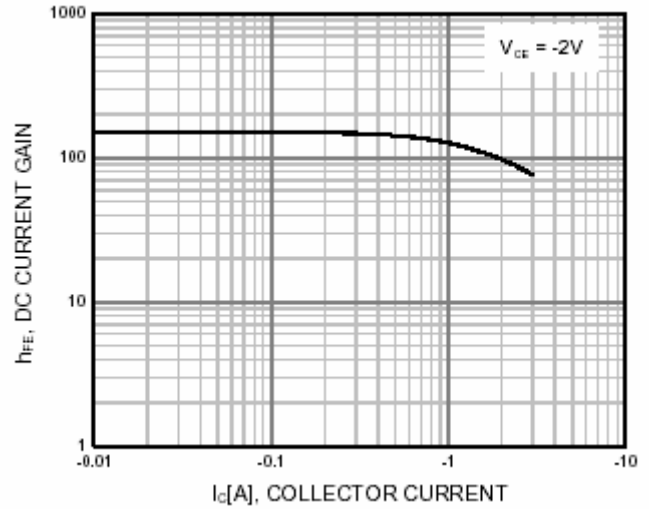

Fig.4 DC current Gain

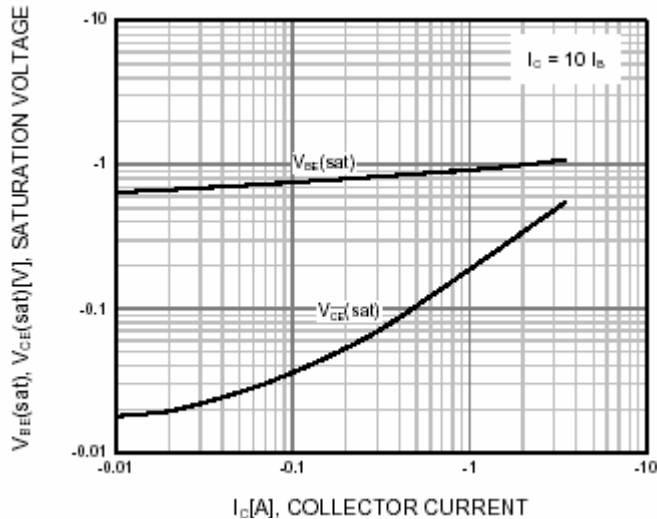

Fig.5 Base-Emitter Saturation Voltage
Collector-Emitter Saturation Voltage

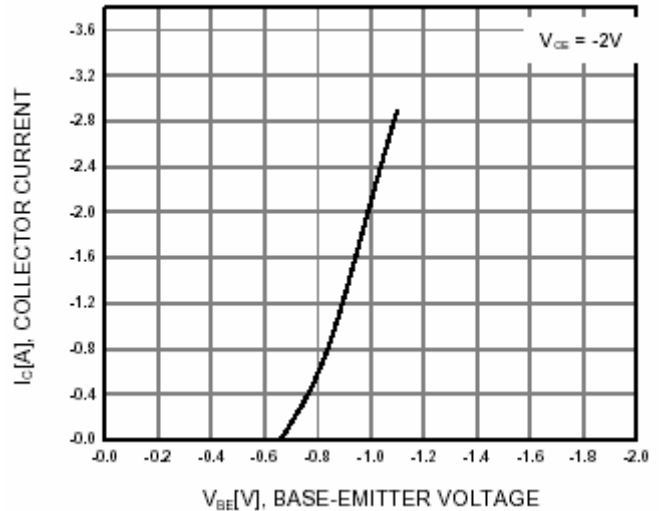

Fig.6 Base-Emitter On Voltage

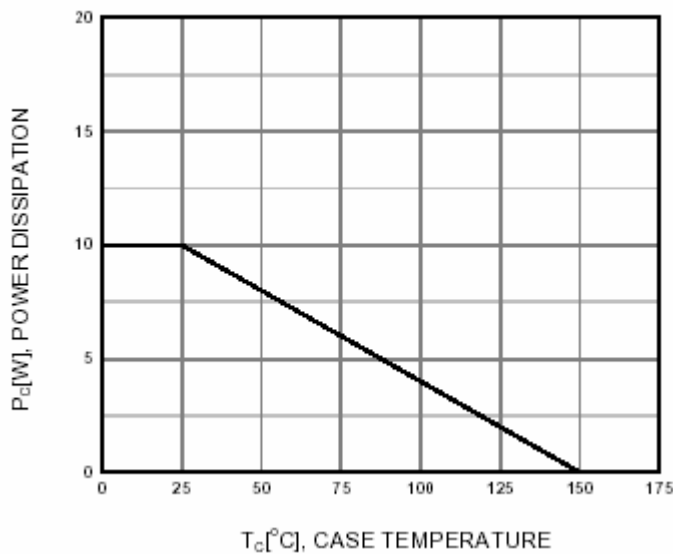

Fig.7 Power Derating

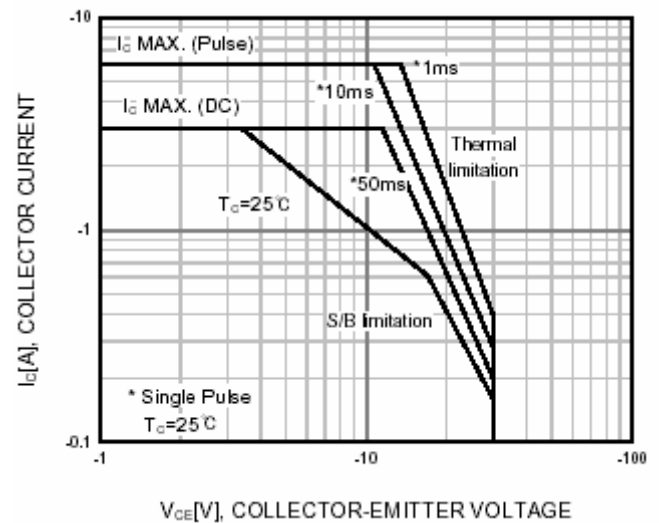

Fig.8 Safe Operating Area