

General Description

This planar stripe MOSFET has better characteristics, such as fast switching time, low on resistance, low gate charge and excellent avalanche characteristics. It is mainly suitable for switch mode power supplies.

FEATURES

- $V_{DSS}=650V$, $I_D=4A$
- Drain-Source ON Resistance
: $R_{DS(ON)}=3.0\ \Omega$ @ $V_{GS} = 10V$
- $Qg(\text{typ.})=20nC$

MAXIMUM RATING (Tc=25°C)

CHARACTERISTIC	SYMBOL	RATING		UNIT	
		KHB4D0N65P	KHB4D0N65F		
Drain-Source Voltage	V_{DSS}	650		V	
Gate-Source Voltage	V_{GSS}	± 30		V	
Drain Current	@T _c =25°C	I_D	4.0	4.0*	A
	Pulsed (Note1)	I_{DP}	16	16*	
Single Pulsed Avalanche Energy (Note 2)	E_{AS}	260		mJ	
Repetitive Avalanche Energy (Note 1)	E_{AR}	10.6		mJ	
Peak Diode Recovery dv/dt (Note 3)	dv/dt	4.5		V/ns	
Drain Power Dissipation	T _c =25°C	P_D	106	36	W
	Derate above 25°C		0.85	0.29	
Maximum Junction Temperature	T_j	150		°C	
Storage Temperature Range	T_{stg}	-55~150		°C	
Thermal Characteristics					
Thermal Resistance, Junction-to-Case	R_{thJC}	1.18	3.47	°C/W	
Thermal Resistance, Junction-to-Ambient	R_{thJA}	62.5	62.5	°C/W	

* : Drain current limited by maximum junction temperature.

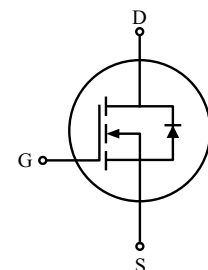
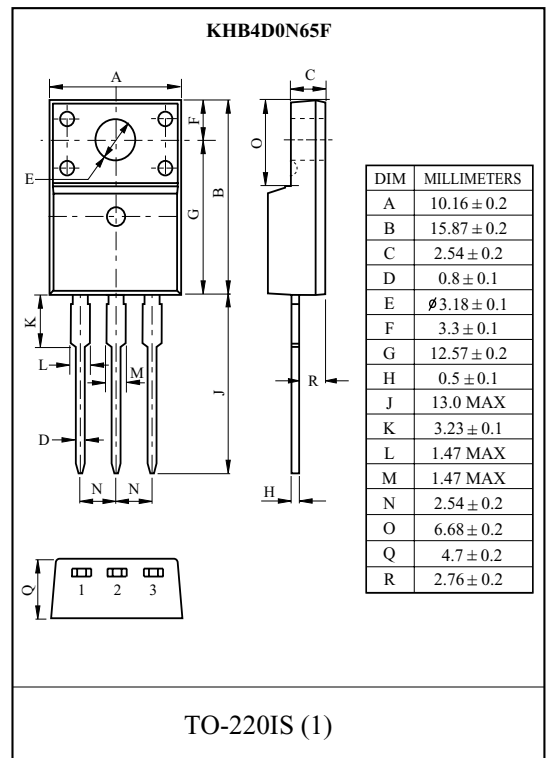
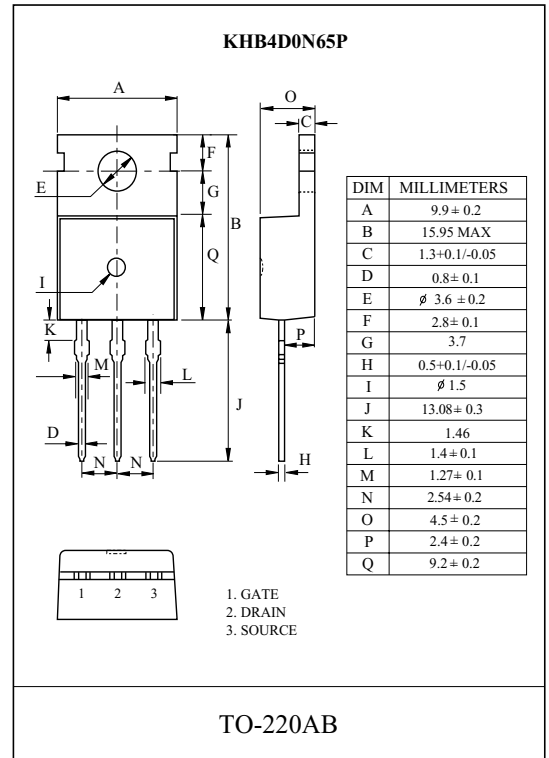

KHB4D0N65P/F

ELECTRICAL CHARACTERISTICS (Tc=25 °C)

CHARACTERISTIC	SYMBOL	TEST CONDITION	MIN.	TYP.	MAX.	UNIT
Static						
Drain-Source Breakdown Voltage	BV_{DSS}	$I_D=250\mu A, V_{GS}=0V$	650	-	-	V
Breakdown Voltage Temperature Coefficient	$\Delta BV_{DSS}/\Delta T_j$	$I_D=250\mu A$, Referenced to 25 °C	-	0.95	-	V/°C
Gate Threshold Voltage	V_{th}	$V_{DS}=V_{GS}, I_D=250\mu A$	2.0	-	4.0	V
Drain Cut-off Current	I_{DSS}	$V_{DS}=650V, V_{GS}=0V$,	-	-	10	μA
Gate Leakage Current	I_{GSS}	$V_{GS}=\pm 30V, V_{DS}=0V$	-	-	± 100	nA
Drain-Source ON Resistance	$R_{DS(ON)}$	$V_{GS}=10V, I_D=2.0A$	-	2.4	3.0	Ω
Forward Transconductance	g_{FS}	$V_{DS}=50V, I_D=2.0A$ (Note4)	-	3.8	-	S
Dynamic						
Total Gate Charge	Q_g	$V_{DS}=520V, I_D=4.0A$ $V_{GS}=10V$ (Note4, 5)	-	20	25	nC
Gate-Source Charge	Q_{gs}		-	4.0	-	
Gate-Drain Charge	Q_{gd}		-	7.5	-	
Turn-on Delay time	$t_{d(on)}$	$V_{DD}=325V, R_G=25\Omega$ $I_D=4.0A$ (Note4, 5)	-	29.5	69	ns
Turn-on Rise time	t_r		-	63.4	136.7	
Turn-off Delay time	$t_{d(off)}$		-	63.2	136.4	
Turn-off Fall time	t_f		-	30	70	
Input Capacitance	C_{iss}	$V_{DS}=25V, V_{GS}=0V, f=1.0MHz$	-	645	838	pF
Output Capacitance	C_{oss}		-	60	78	
Reverse Transfer Capacitance	C_{rss}		-	7.4	9.6	
Source-Drain Diode Ratings						
Continuous Source Current	I_S	$V_{GS}<V_{th}$	-	-	4.0	A
Pulsed Source Current	I_{SP}		-	-	16	
Diode Forward Voltage	V_{SD}	$I_S=4.0A, V_{GS}=0V$	-	-	1.4	V
Reverse Recovery Time	t_{rr}	$I_S=4.0A, V_{GS}=0V$, $dI_S/dt=100A/\mu s$ (Note 4)	-	350	-	ns
Reverse Recovery Charge	Q_{rr}		-	2.7	-	μC

Note 1) Repetivity rating : Pulse width limited by junction temperature.

Note 2) $L=30mH, I_S=4A, V_{DD}=50V, R_G=25\Omega$, Starting $T_j=25^\circ C$.

Note 3) $I_S \leq 4.0A, dI/dt \leq 200A/\mu s, V_{DD} \leq BV_{DSS}$, Starting $T_j=25^\circ C$.

Note 4) Pulse Test : Pulse width $\leq 300\mu s$, Duty Cycle $\leq 2\%$.

Note 5) Essentially independent of operating temperature.

KHB4D0N65P/F

$I_D - V_{DS}$

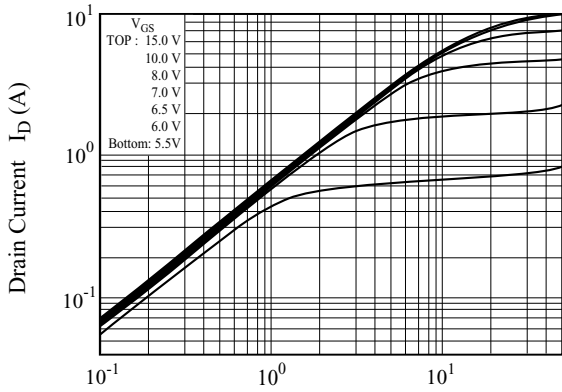

Drain - Source Voltage V_{DS} (V)

$I_D - V_{GS}$

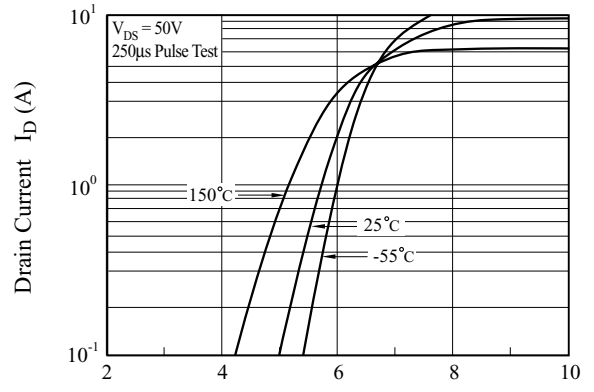

Gate - Source Voltage V_{GS} (V)

$BV_{DSS} - T_j$

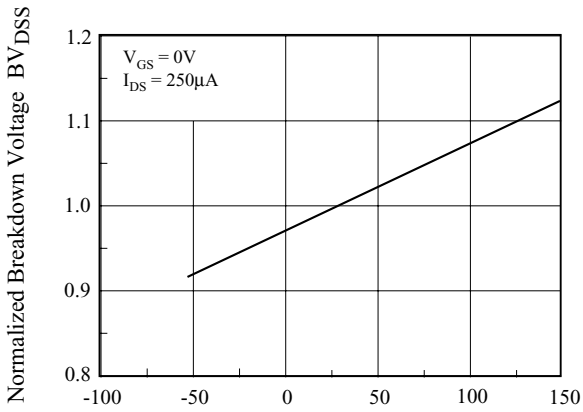

Junction Temperature T_j ($^{\circ}C$)

$R_{DS(ON)} - I_D$

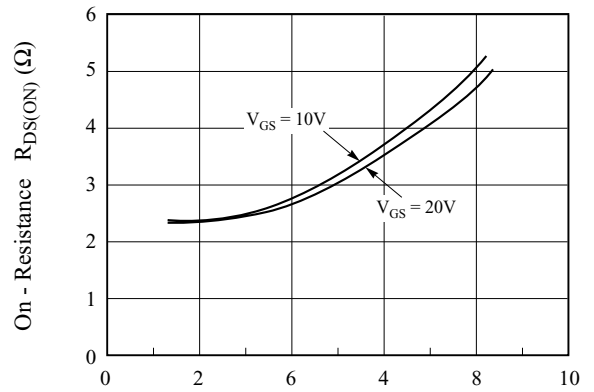

Drain Current I_D (A)

$I_S - V_{SD}$

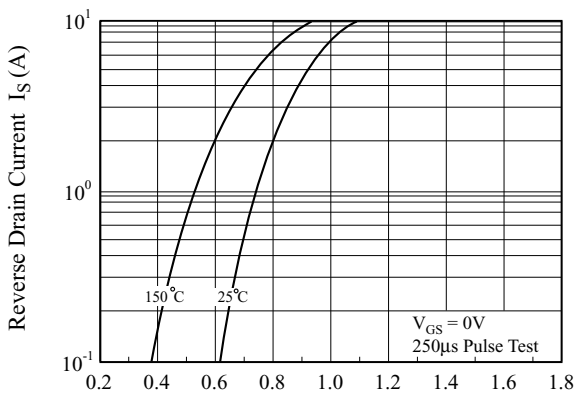

Source - Drain Voltage V_{SD} (V)

$R_{DS(ON)} - T_j$

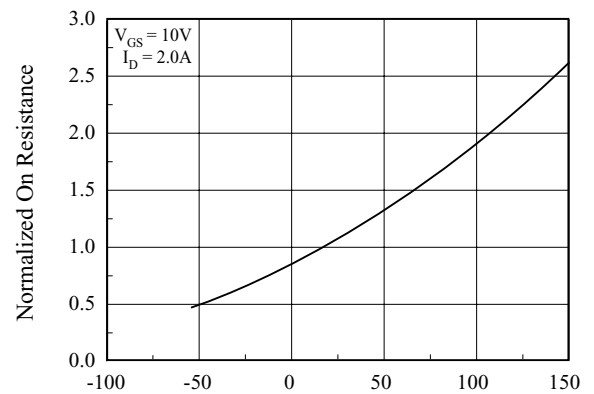

Junction Temperature T_j ($^{\circ}C$)

KHB4D0N65P/F

C - V_{DS}

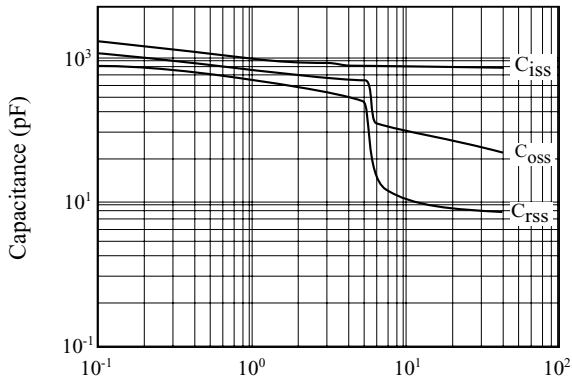

Drain - Source Voltage V_{DS} (V)

Q_g- V_{GS}

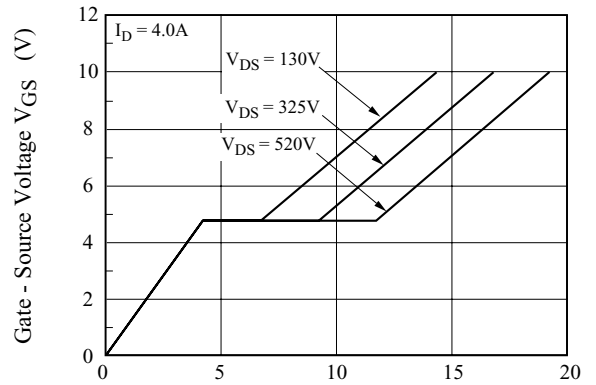

Gate - Charge Q_g (nC)

Safe Operation Area

(KHB4D0N65P)

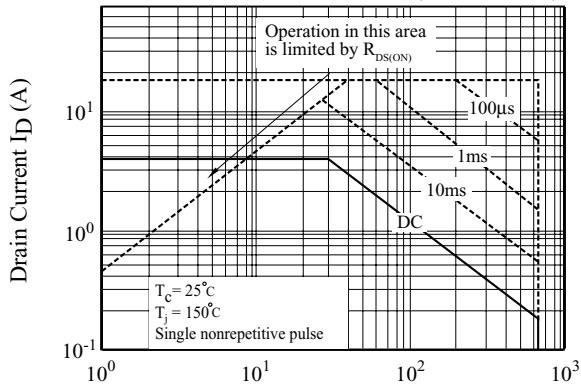

Drain - Source Voltage V_{DS} (V)

Safe Operation Area

(KHB4D0N651)

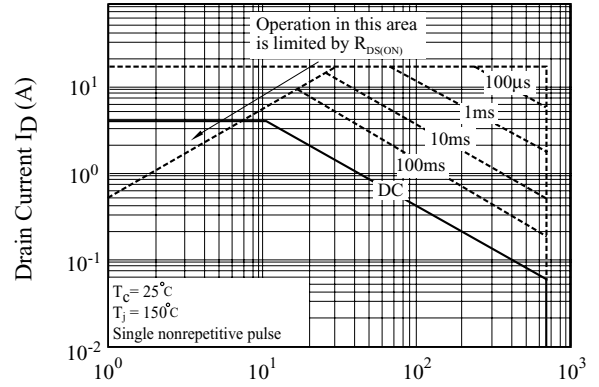

Drain - Source Voltage V_{DS} (V)

I_D - T_j

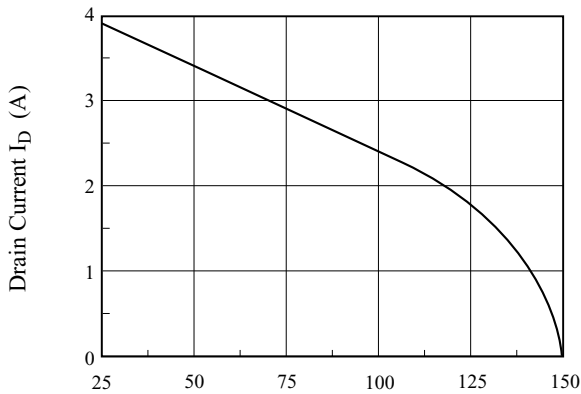

Junction Temperature T_j (°C)

KHB4D0N65P/F

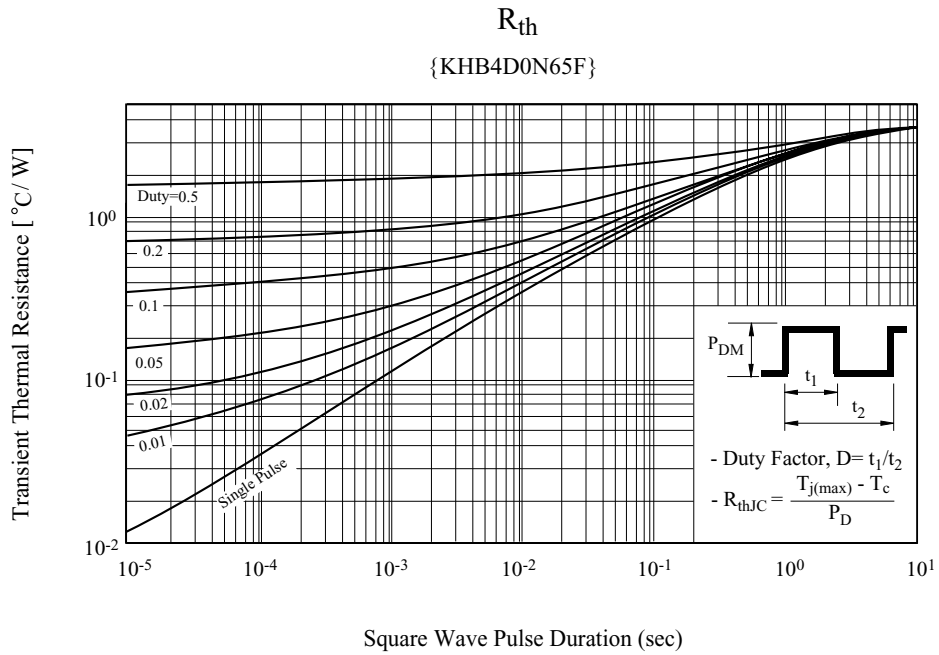
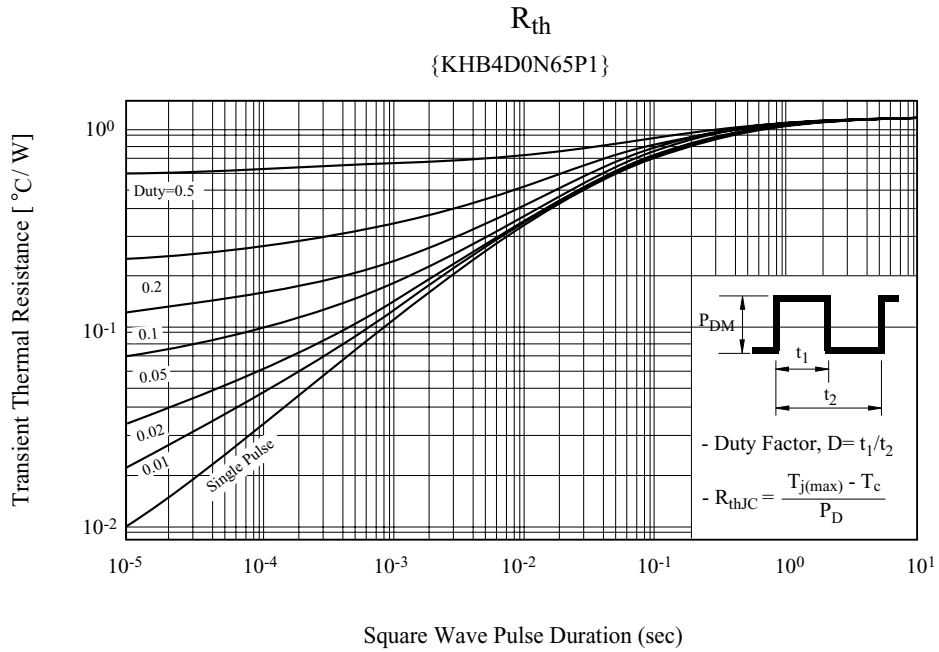

KHB4D0N65P/F

- Gate Charge

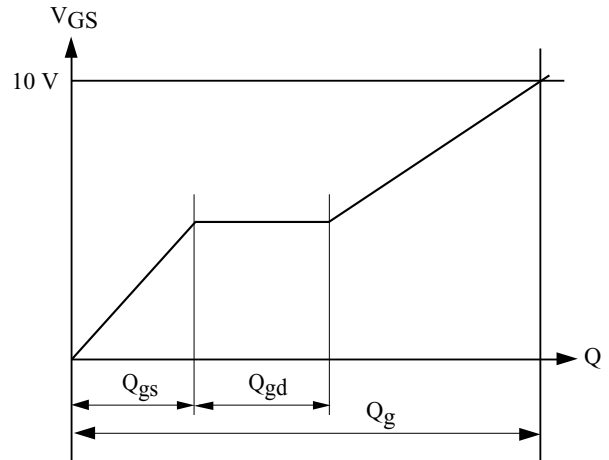
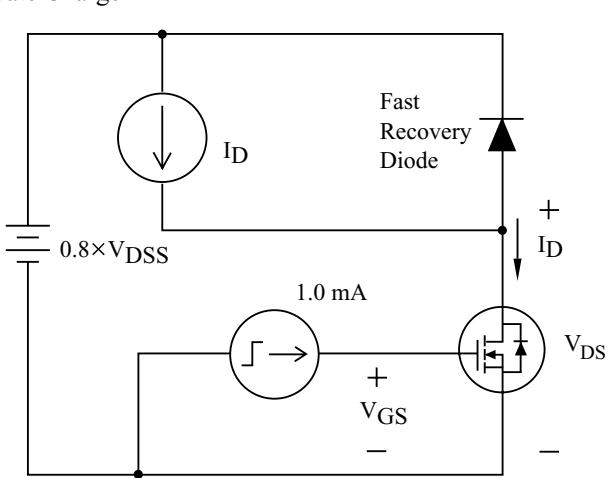

- Single Pulsed Avalanche Energy

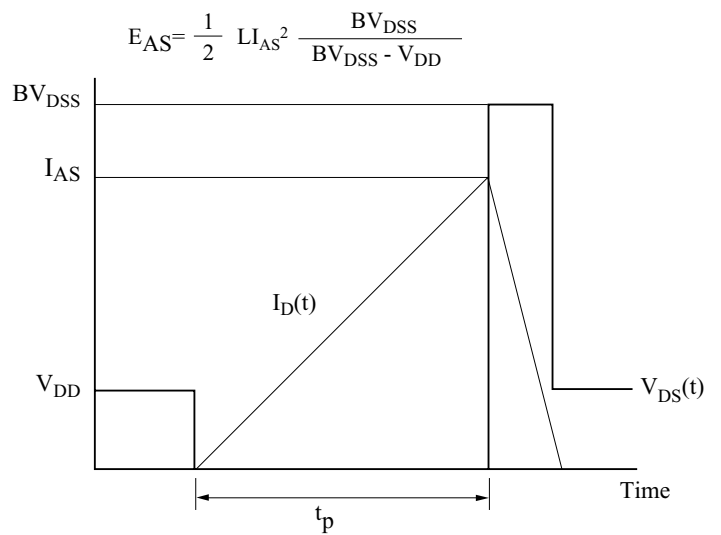
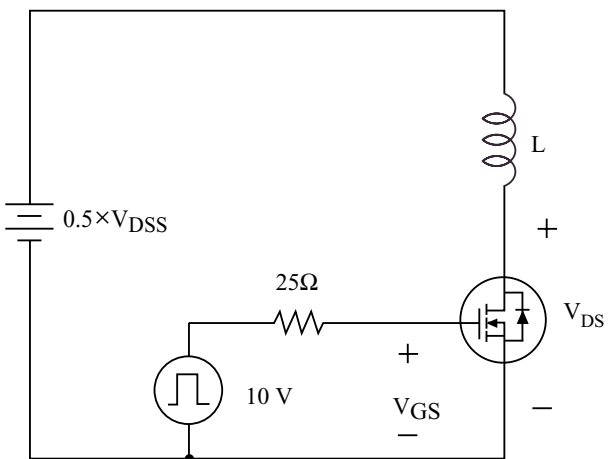

KHB4D0N65P/F

- Resistive Load Switching

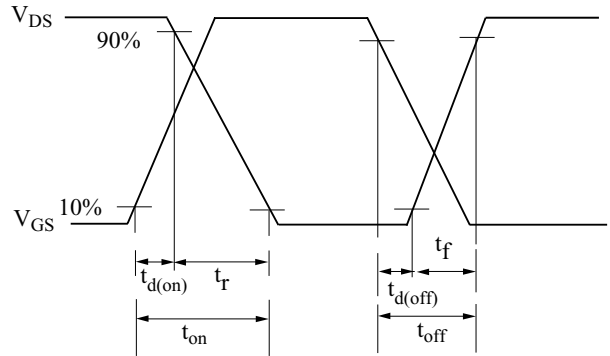
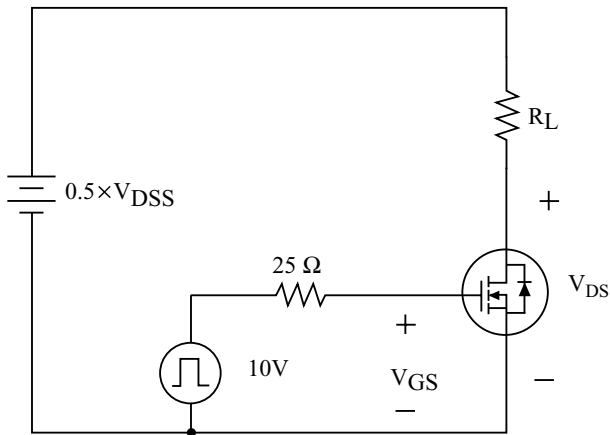

- Source - Drain Diode Reverse Recovery and dv/dt

