

TECHNICAL DESCRIPTION

FEATURES

- 1.9 - 2.3 GHz
- LOW LOSS
- LOW VSWR
- HIGH POWER
- HIGH DIRECTIVITY
- SURFACE MOUNT
- TAPE & REEL



The Multi-Mix® CSDZ-SH series provides a 10 dB coupler with low insertion loss, low VSWR, and high directivity. Accurate coupling factors make them ideal for applications involving power amplifiers, signal distribution and processing.

CSDZ-SH Directional Couplers are fusion bonded multilayer stripline assemblies. The fusion bonding process yields a homogeneous monolithic dielectric structure with reliability, ruggedness, and electrical performance that is superior to conventional adhesive bonding techniques.

GENERAL SPECIFICATIONS

FREQUENCY RANGE GHz		MEAN COUPLING	INSERTION LOSS (dB MAX)	VSWR (MAX)	FREQUENCY SENSITIVITY (dB MAX)
1.9 - 2.3		10.1 ± 0.5 dB	0.14	1.17:1	± 0.10
DIRECTIVITY (dB, MIN)	INPUT POWER	SIZE (INCHES)	WEIGHT (OZ./GRAMS)	RF INTERFACE	OPERATING TEMPERATURE
22	150 W	0.56 x 0.20 x 0.064	0.02 / 0.6	Surface Mount	-55° - +95° C

PACKAGE OUTLINE / TAPE & REEL ORIENTATION

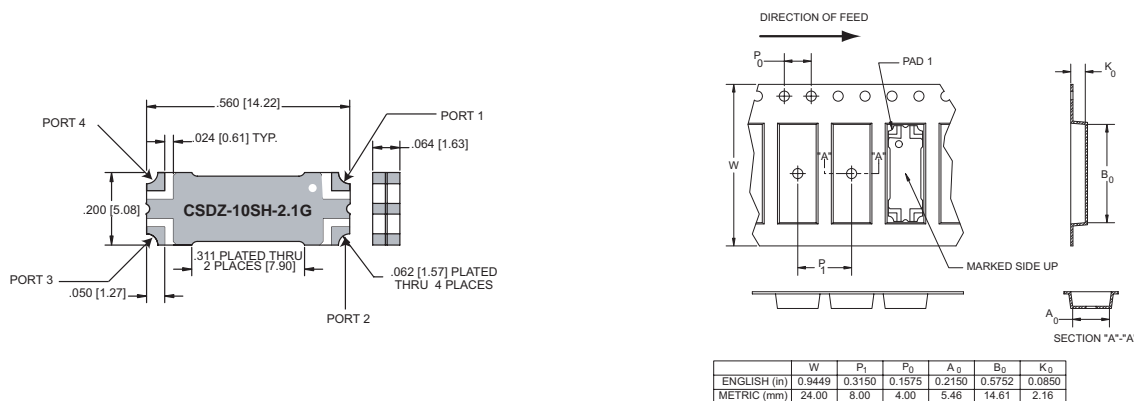

THE MULTI-MIX MICROTECHNOLOGY® GROUP IS ISO 9001:2000 REGISTERED



U.S. Patent 6,099,677 and other Patents Pending.

TYPICAL PERFORMANCE

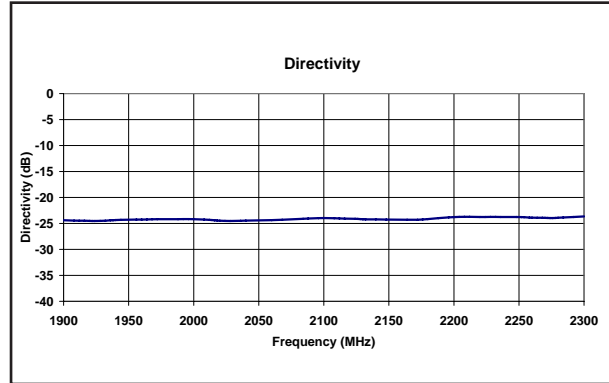
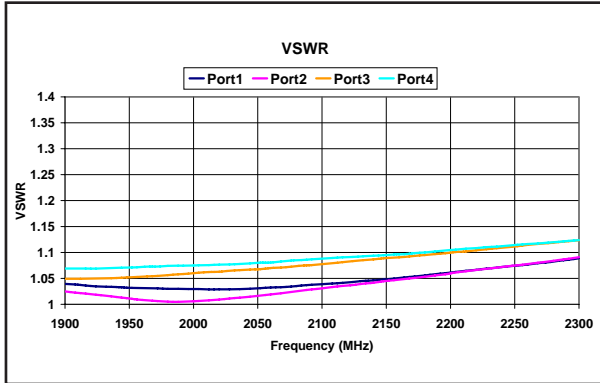
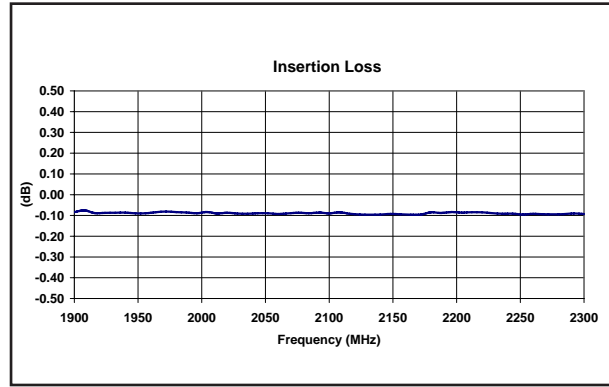
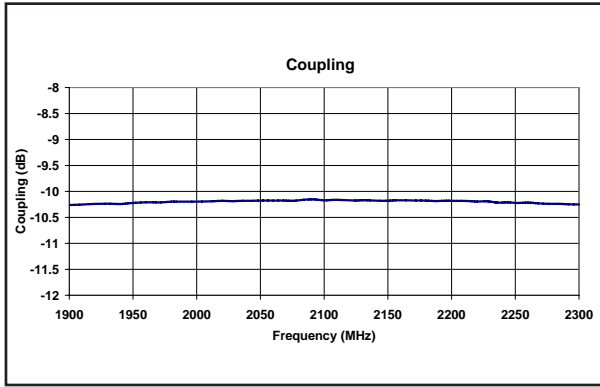

MOUNTING CONFIGURATION

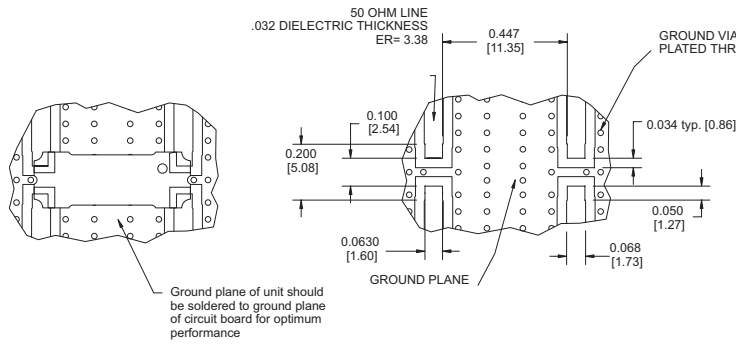

TRUTH TABLE

	1	2	3	4
1	Input	Coupled	Isolated	Out
2	Coupled	In	Out	Isolated
3	Isolated	Out	Input	Coupled
4	Out	Isolated	Coupled	Input