

Features

- 1.2 INCH CHARACTER HEIGHT.
- LOW CURRENT OPERATION.
- HIGH CONTRAST AND LIGHT OUTPUT.
- EASY MOUNTING ON P.C. BOARDS OR SOCKETS.
- CATEGORIZED FOR LUMINOUS INTENSITY.
- MECHANICALLY RUGGED.
- STANDARD : GRAY FACE, WHITE SEGMENT.
- RoHS COMPLIANT.

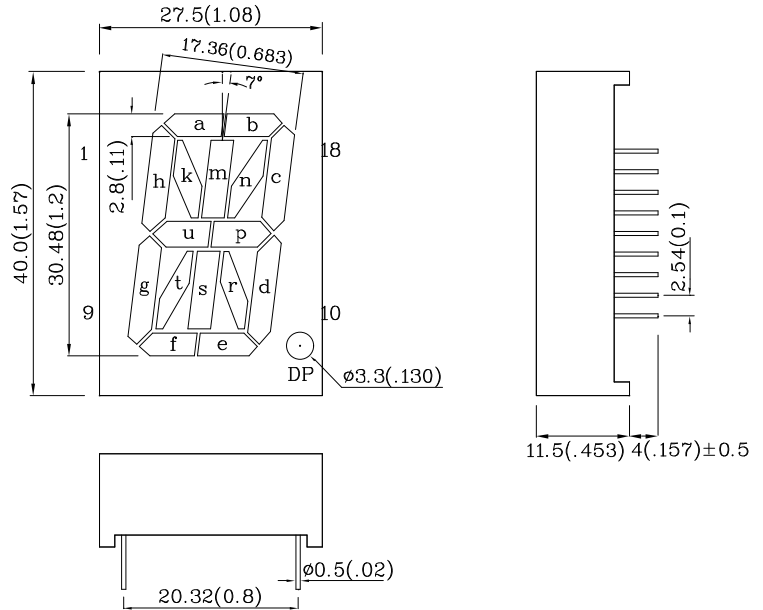
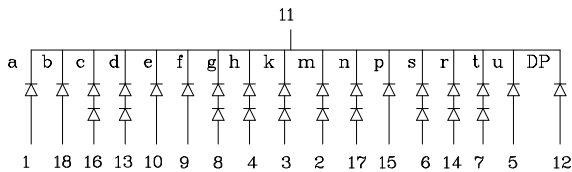

Notes:

1. All dimensions are in millimeters (inches).
2. Tolerance is $\pm 0.25(0.01)$ " unless otherwise noted.
3. Specifications are subject to change without notice.

Absolute Maximum Ratings (TA=25°C)		UY (GaAsP/ GaP)	Unit
Reverse Voltage	c,d,g,h,k,m,n, s,r,t	VR	10
	a,b,e,f,p,u and DP		5
DC Forward Current	c,d,g,h,k,m,n, s,r,t	IF	30
	a,b,e,f,p,u and DP		
Forward Current (Peak) 1/10 Duty Cycle 0.1ms Pulse Width	c,d,g,h,k,m,n, s,r,t	iFS	140
	a,b,e,f,p,u and DP		
Power Dissipation	c,d,g,h,k,m,n, s,r,t	PT	150
	a,b,e,f,p,u and DP		75
Operating Temperature		TA	-40 ~ +85
Storage Temperature		Tstg	-40 ~ +85
Lead Solder Temperature [2mm Below Package Base]		260°C For 3~5 Seconds	

Operating Characteristics (TA=25°C)		UY (GaAsP/ GaP)	Unit
Forward Voltage (Typ.) (IF=10mA)	c,d,g,h,k,m,n ,s,r,t	VF	3.9
	a,b,e,f,p,u and DP		1.95
Forward Voltage (Max.) (IF=10mA)	c,d,g,h,k,m,n ,s,r,t	VF	5
	a,b,e,f,p,u and DP		2.5
Reverse Current (Max.) (VR=10V(5V))	c,d,g,h,k,m,n ,s,r,t	IR	10
	a,b,e,f,p,u and DP		uA
Wavelength of Peak Emission (Typ.) (IF=10mA)		λP	590
Wavelength of Dominant Emission (Typ.) (IF=10mA)		λD	588
Spectral Line Full Width At Half- Maximum (Typ.)(IF=10mA)		$\Delta\lambda$	35
Capacitance (Typ.) (VF=0V, f=1MHz)		C	20

Part Number	Emitting Color	Emitting Material	Luminous Intensity (IF=10mA) ucd		Wavelength nm λ P	Description
			min.	typ.		
AUY30C	Yellow	GaAsP/GaP	1200	4690	590	Common Cathode, Rt. Hand Decimal

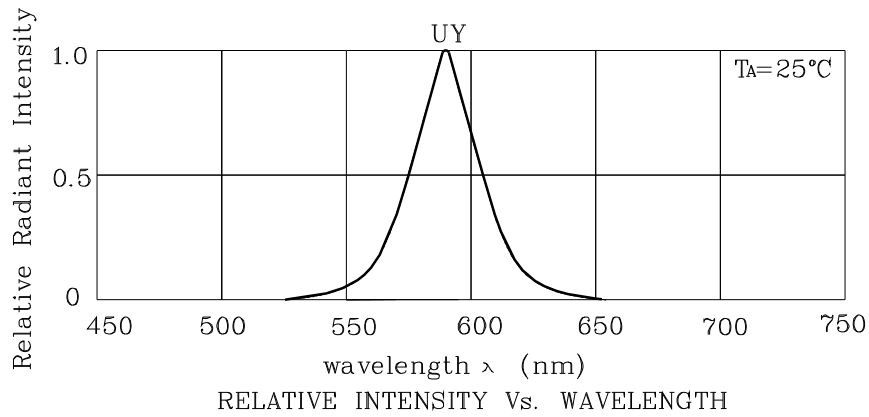

❖ UY

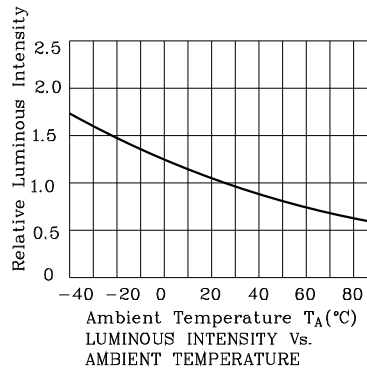
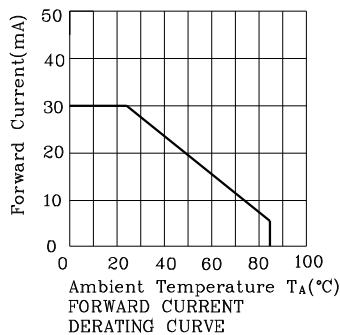
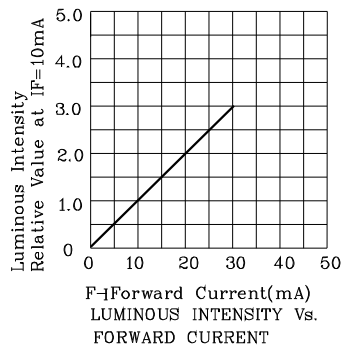
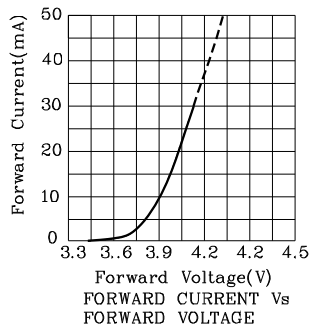

Note: the curves are on the segment c,d,g,h,k,m,n,s,r and t.

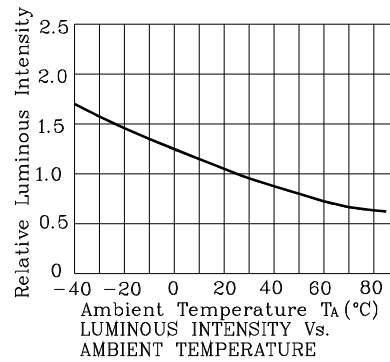
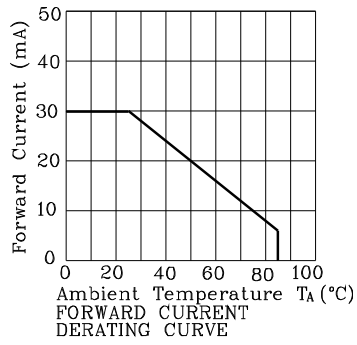
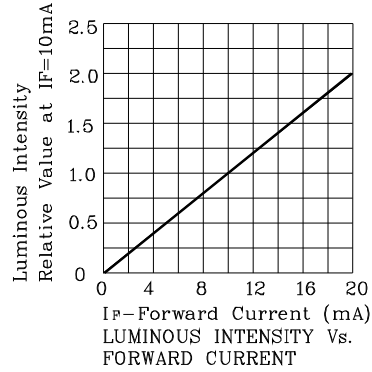
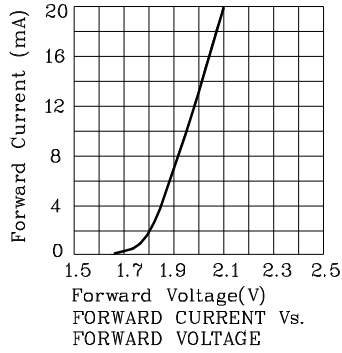

Note:the curves are on the segment a,b,e,f,p,u and DP.

Wave Soldering Profile For Lead-free Through-hole LED.

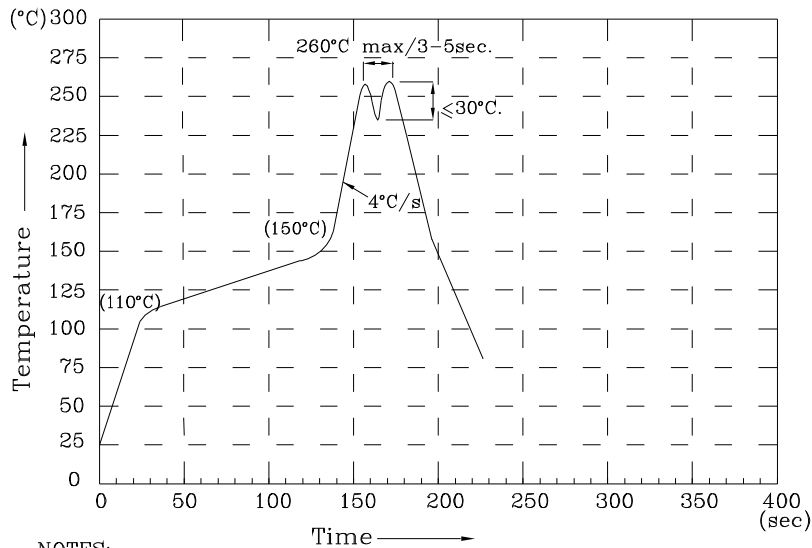

NOTES:

- 1.Recommend the wave temperature 245°C~260°C.The maximum soldering temperature should be less than 260°C.
- 2.Do not apply stress on epoxy resins when temperature is over 85 degree°C.
- 3.The soldering profile apply to the lead free soldering (Sn/Cu/Ag alloy).
- 4.No more than once.

Remarks:

If special sorting is required (e.g. binning based on forward voltage, luminous intensity / luminous flux or wavelength), the typical accuracy of the sorting process is as follows:

1. Wavelength: +/-1nm
2. Luminous Intensity / Luminous Flux: +/-15%
3. Forward Voltage: +/-0.1V

Note: Accuracy may depend on the sorting parameters.

PACKING & LABEL SPECIFICATIONS

AUY30C

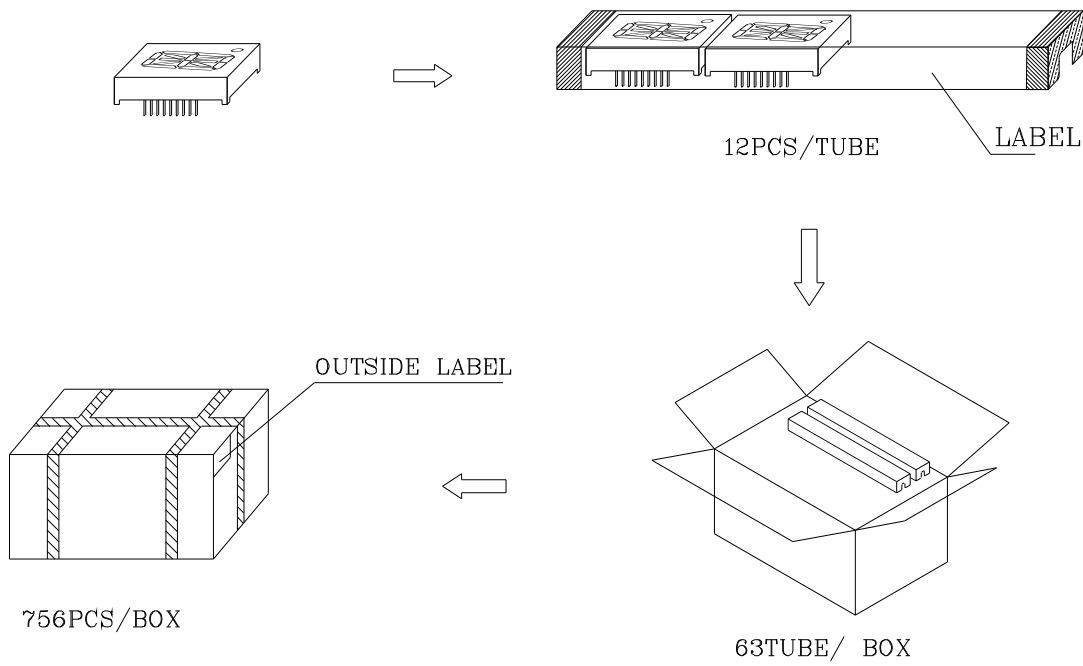

Inside LABEL Paste On The IC-tube

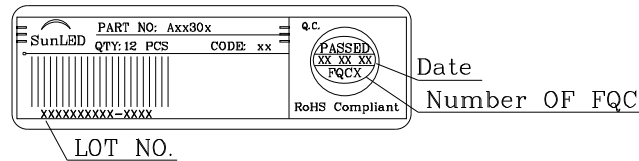

Outside LABEL Paste On The Box

