

## Silicon NPN Power Transistors

2SC4140

**DESCRIPTION**

- With TO-3PN package
- High voltage
- High speed switching

**APPLICATIONS**

- For switching regulator and general purpose applications

**PINNING**

PIN	DESCRIPTION
1	Base
2	Collector;connected to mounting base
3	Emitter

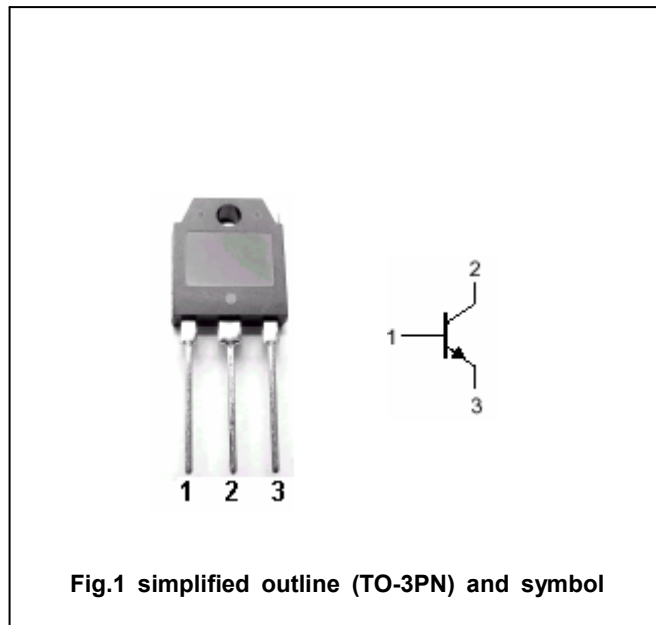

Fig.1 simplified outline (TO-3PN) and symbol

**Absolute maximum ratings(Ta=□)**

SYMBOL	PARAMETER	CONDITIONS	VALUE	UNIT
$V_{CBO}$	Collector-base voltage	Open emitter	500	V
$V_{CEO}$	Collector-emitter voltage	Open base	400	V
$V_{EBO}$	Emitter-base voltage	Open collector	10	V
$I_C$	Collector current		18	A
$I_{CP}$	Collector current-pulse		36	A
$I_B$	Base current		6	A
$P_C$	Collector power dissipation	$T_C=25^\circ$	130	W
$T_j$	Junction temperature		150	□
$T_{stg}$	Storage temperature		-55~150	□

## Silicon NPN Power Transistors

## 2SC4140

## CHARACTERISTICS

T<sub>j</sub>=25°C unless otherwise specified

SYMBOL	PARAMETER	CONDITIONS	MIN	TYP.	MAX	UNIT
V <sub>(BR)CEO</sub>	Collector-emitter breakdown voltage	I <sub>C</sub> =25mA ; I <sub>B</sub> =0	400			V
V <sub>CEsat</sub>	Collector-emitter saturation voltage	I <sub>C</sub> =10A; I <sub>B</sub> =2A			0.5	V
V <sub>BEsat</sub>	Base-emitter saturation voltage	I <sub>C</sub> =10A; I <sub>B</sub> =2A			1.3	V
I <sub>CBO</sub>	Collector cut-off current	V <sub>CB</sub> =500V ; I <sub>E</sub> =0			100	μA
I <sub>EBO</sub>	Emitter cut-off current	V <sub>EB</sub> =10V; I <sub>C</sub> =0			100	μA
h <sub>FE</sub>	DC current gain	I <sub>C</sub> =10A ; V <sub>CE</sub> =4V	10		30	
f <sub>T</sub>	Transition frequency	I <sub>E</sub> =-2A ; V <sub>CE</sub> =12V		10		MHz
C <sub>OB</sub>	Collector output capacitance	f=1MHz ; V <sub>CB</sub> =10V		165		pF

## Switching times

t <sub>on</sub>	Turn-on time	I <sub>C</sub> =10A; I <sub>B1</sub> =1A; I <sub>B2</sub> =-2A; R <sub>L</sub> =20Ω V <sub>CC</sub> =200V			1.0	μs
t <sub>stg</sub>	Storage time				3.0	μs
t <sub>f</sub>	Fall time				0.5	μs

Silicon NPN Power Transistors

2SC4140

PACKAGE OUTLINE

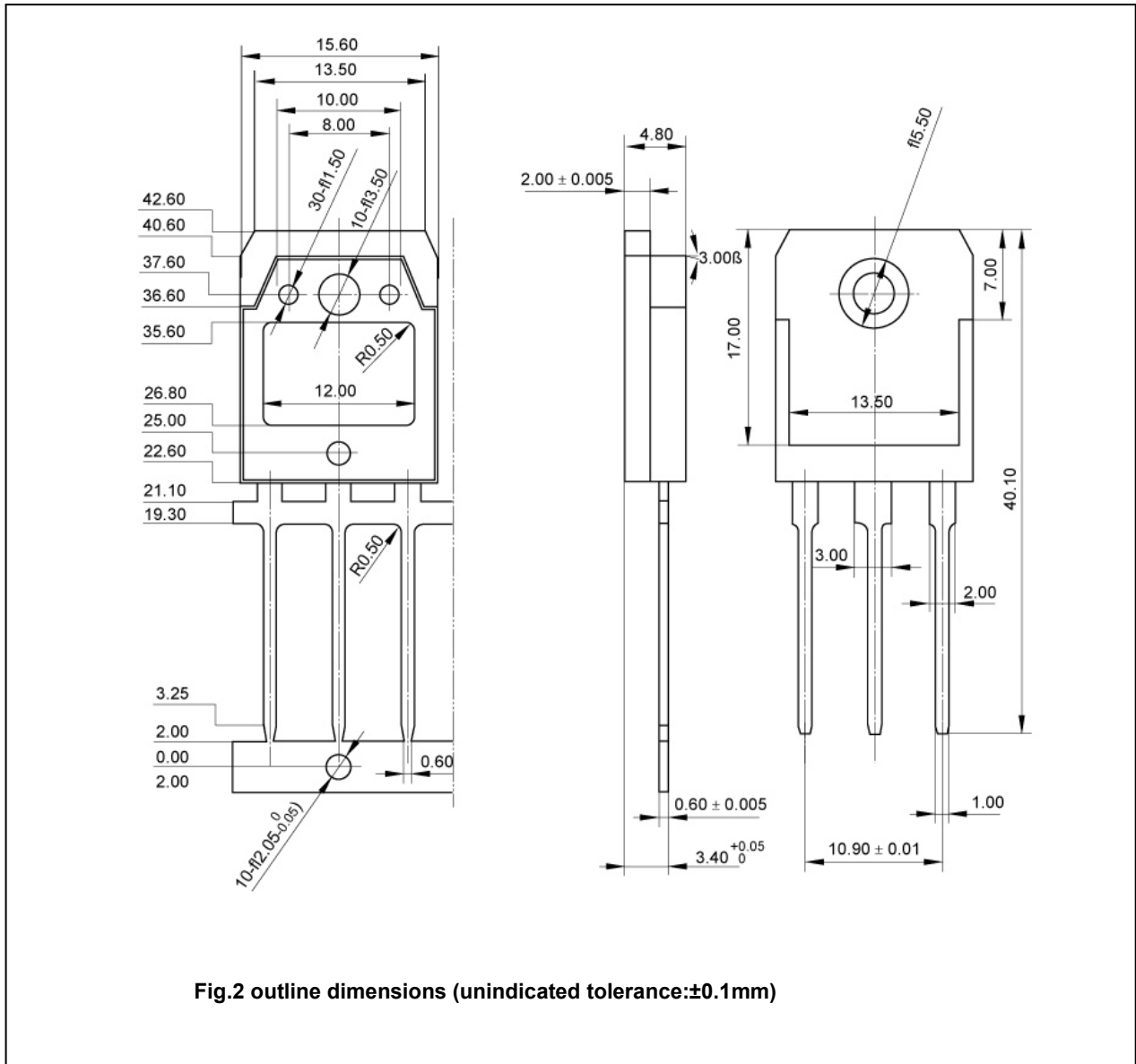

Fig.2 outline dimensions (unindicated tolerance:  $\pm 0.1$  mm)

Silicon NPN Power Transistors

2SC4140

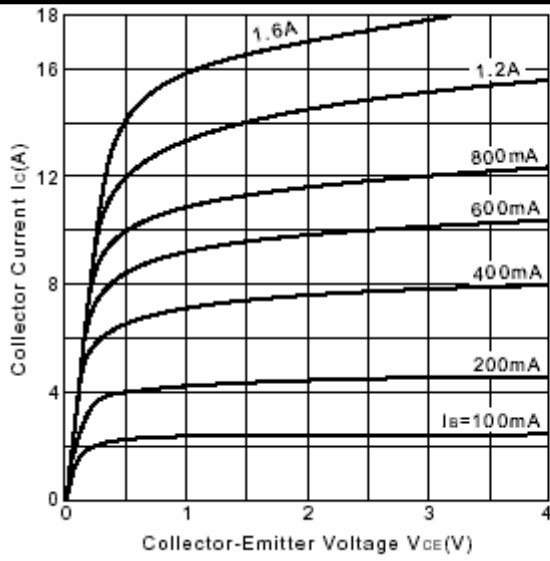

Fig.3 Static Characteristic

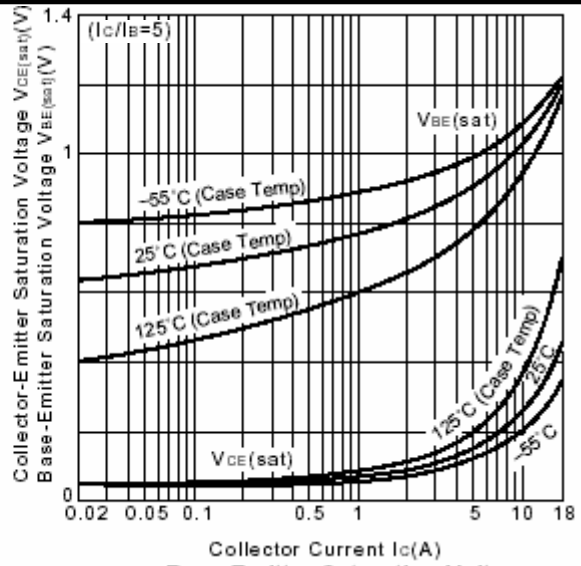

Fig.4 Base-Emitter Saturation Voltage  
Collector-Emitter Saturation Voltage

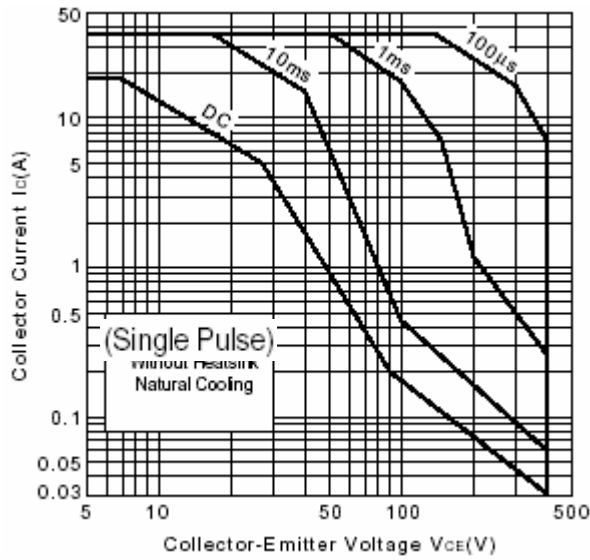

Fig.5 Safe Operating Area

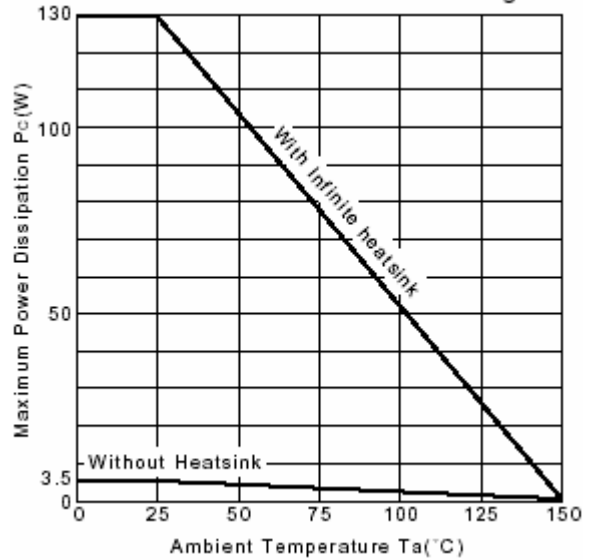

Fig.6 Pc-Ta Derating

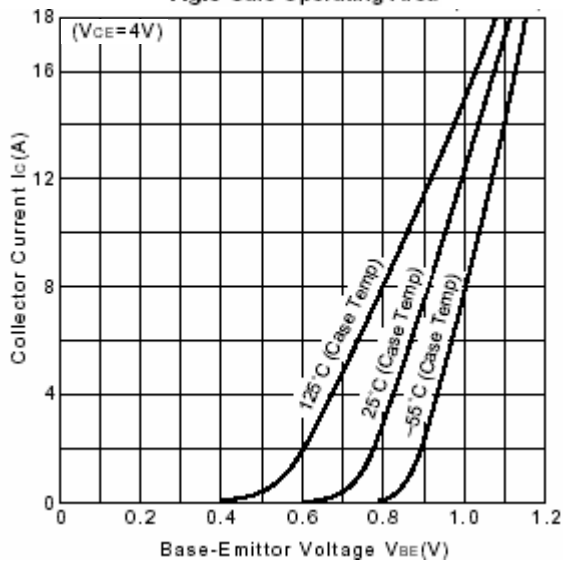

Fig.7  $I_c - V_{BE}$

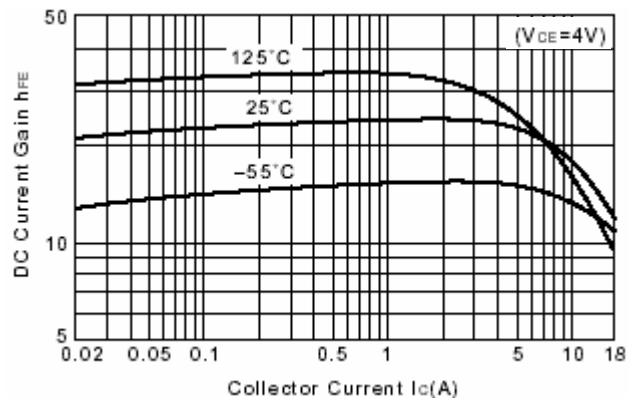

Fig.8 DC current Gain