

ATF-36163

1.5 – 18 GHz Surface Mount Pseudomorphic HEMT



Data Sheet

Description

The Avago ATF-36163 is a low-noise Pseudomorphic High Electron Mobility Transistor (PHEMT), in the SOT-363 (SC-70) package. When optimally matched for minimum noise figure, it will provide a noise figure of 1 dB at 12 GHz and 0.6 dB at 4 GHz.

Additionally, the ATF-36163 has low noise-resistance, which reduces the sensitivity of noise performance to variations in input impedance match. This feature makes the design of broad band low noise amplifiers much easier. The performance of the ATF-36163 makes this device the ideal choice for use in the 2nd or 3rd stage of low noise cascades. The repeatable performance and consistency make it appropriate for use in Ku-band Direct Broadcast Satellite (DBS) TV systems, C-band TV Receive Only (TVRO) LNAs, Multichannel Multipoint Distribution Systems (MMDS), X-band Radar detector and other low noise amplifiers operating in the 1.5 – 18 GHz frequency range.

This GaAs PHEMT device has a nominal 0.2 micron gate length with a total gate periphery (width) of 200 microns. Proven gold-based metallization system and nitride passivation assure rugged, reliable devices.

Surface Mount Package SOT-363 (SC-70)

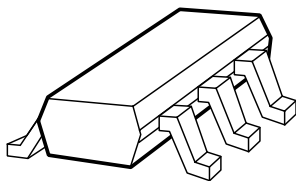

Features

- Lead-free Option Available
- Low Minimum Noise Figure:
 - 1 dB Typical at 12 GHz
 - 0.6 dB Typical at 4 GHz
- Associated Gain:
 - 9.4 dB Typical at 12 GHz
 - 15.8 dB Typical at 4 GHz
- Maximum Available Gain:
 - 11 dB Typical at 12 GHz
 - 17 dB Typical at 4 GHz
- Low Cost Surface Mount Small Plastic Package
- Tape-and-Reel Packaging Option Available

Applications

- 12 GHz DBS Downconverters
- 4 GHz TVRO Downconverters
- S or L Band Low Noise Amplifiers

Pin Connections and Package Marking

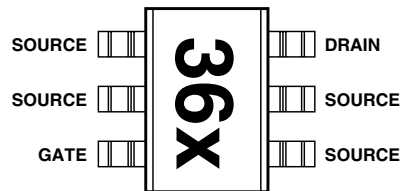

Note: Top View. Package marking provides orientation and identification.

"36" = Device code
"X" = Data code character



Attention: Observe precautions for handling electrostatic sensitive devices.
ESD Machine Model (Class A)
Refer to Avago Application Note A004R:
Electrostatic Discharge Damage and Control.

ATF-36163 Absolute Maximum Ratings^[1]

Symbol	Parameter	Units	Absolute Maximum
V _{DS}	Drain - Source Voltage	V	+3
V _{GS}	Gate - Source Voltage	V	-3
V _{GD}	Gate Drain Voltage	V	-3.5
I _D	Drain Current	mA	I _{dss}
P _T	Total Power Dissipation	mW	180
P _{in max}	RF Input Power	dBm	+10
T _{CH}	Channel Temperature	°C	150
T _{STG}	Storage Temperature	°C	-65 to 150

Thermal Resistance:

$$\theta_{ch-c} = 160^{\circ}\text{C/W}$$

Note:

1. Operation of this device above any one of these parameters may cause permanent damage.

ATF-36163 Electrical Specifications T_C = 25°C, Z_O = 50 Ω, V_{ds} = 1.5 V, I_{ds} = 10 mA, (unless otherwise noted).

Symbol	Parameters and Test Conditions	Units	Min.	Typ.	Max.
NF	Noise Figure ^[1] f = 12.0 GHz	dB		1.2	1.4 ^[1]
G	Gain at NF ^[1] f = 12.0 GHz	dB	9	10	
g _m	Transconductance V _{DS} = 1.5 V, V _{GS} = 0 V	mS	50	60	
I _{dss}	Saturated Drain Current V _{DS} = 1.5 V, V _{GS} = 0 V	mA	15	25	40
V _{p 10%}	Pinchoff Voltage V _{DS} = 1.5 V, I _{DS} = 10% of I _{dss}	V	-1.0	-0.35	-0.15
BV _{GDO}	Gate Drain Breakdown Voltage I _G = 30 μA	V			-3.5

Note:

1. Measured in a test circuit tuned for a typical device.

ATF-36163 Typical Parameters T_C = 25°C, Z_O = 50 Ω, V_{ds} = 2 V, I_{ds} = 15 mA, (unless otherwise noted).

Symbol	Parameters and Test Conditions	Units	Typ.
F _{min}	Minimum Noise Figure (Γ _{source} = Γ _{opt}) f = 4 GHz	dB	0.6
		f = 12 GHz	1.0
G _a	Associated Gain f = 4 GHz	dB	15.8
		f = 12 GHz	9.4
G _{max}	Maximum Available Gain ^[1] f = 4 GHz	dB	17.2
		f = 12 GHz	10.9
P _{1dB}	Output Power at 1 dB Gain Compression under the power matched condition f = 4 GHz	dBm	5
		f = 12 GHz	5
V _{GS}	Gate to Source Voltage for I _{DS} = 15 mA V _{DS} = 2.0 V	V	-0.2

Note:

1. G_{max} = MAG for K > 1 and G_{max} = MSG for K ≤ 1, which is shown on the S-parameters tables.

ATF-36163 Typical Scattering Parameters, Common Source, $Z_0 = 50 \Omega$, $V_{DS} = 1.5 \text{ V}$, $I_D = 10 \text{ mA}$

Freq. GHz	S_{11}			S_{21}			S_{12}			S_{22}		K	$G_{max}^{[1]}$ dB
	Mag.	Ang.	dB	Mag.	Ang.	dB	Mag.	Ang.	Mag.	Ang.			
0.5	0.99	-11	12.85	4.39	168	-37.72	0.01	79	0.51	-9	0.11	25.24	
1	0.98	-22	12.70	4.31	158	-31.70	0.03	71	0.50	-18	0.17	22.26	
2	0.96	-42	12.48	4.21	138	-26.02	0.05	55	0.48	-36	0.24	19.28	
3	0.93	-61	12.37	4.15	118	-22.73	0.07	40	0.45	-53	0.33	17.56	
4	0.87	-83	12.30	4.12	97	-20.45	0.10	23	0.40	-71	0.43	16.38	
5	0.81	-106	12.16	4.06	76	-18.71	0.12	6	0.34	-92	0.51	15.43	
6	0.75	-131	11.94	3.95	55	-17.52	0.13	-12	0.27	-116	0.58	14.73	
7	0.67	-158	11.47	3.75	33	-16.77	0.15	-30	0.18	-144	0.69	14.12	
8	0.61	176	11.01	3.55	12	-16.36	0.15	-45	0.10	174	0.79	13.69	
9	0.57	143	10.47	3.34	-10	-15.97	0.16	-61	0.12	93	0.85	13.22	
10	0.57	108	9.66	3.04	-32	-15.92	0.16	-77	0.22	53	0.91	12.80	
11	0.59	76	8.53	2.67	-54	-16.48	0.15	-93	0.33	28	0.99	12.50	
12	0.63	50	7.39	2.34	-74	-17.14	0.14	-106	0.41	9	1.07	10.65	
13	0.67	26	6.10	2.02	-93	-18.27	0.12	-119	0.49	-8	1.18	9.64	
14	0.72	6	4.81	1.74	-111	-19.74	0.10	-129	0.56	-22	1.30	8.99	
15	0.78	-11	3.49	1.50	-128	-21.41	0.09	-138	0.63	-33	1.38	8.81	
16	0.82	-24	2.20	1.29	-146	-23.10	0.07	-144	0.67	-43	1.44	8.70	
17	0.87	-38	0.59	1.07	-164	-25.04	0.06	-151	0.73	-53	1.46	8.79	
18	0.90	-52	-1.63	0.83	178	-29.12	0.04	-159	0.78	-65	1.80	8.58	

Note:

1. G_{max} = MAG for $K > 1$ and G_{max} = MSG for $K \leq 1$.

ATF-36163 Typical Noise Parameters

Common Source, $Z_0 = 50 \Omega$, $V_{DS} = 1.5 \text{ V}$, $I_D = 10 \text{ mA}$

Freq. GHz	F_{min} dB	G_a dB	Γ_{opt}		R_n/Z_0 -
			Mag.	Ang.	
2	0.48	18.77	0.78	28	0.38
3	0.53	16.75	0.75	41	0.32
4	0.57	15.17	0.68	55	0.26
5	0.61	14.14	0.60	71	0.20
6	0.66	13.23	0.55	88	0.15
7	0.71	12.06	0.48	105	0.12
8	0.77	11.22	0.38	119	0.10
9	0.83	10.50	0.32	138	0.07
10	0.89	10.02	0.23	170	0.07
11	0.97	9.44	0.18	-141	0.09
12	1.05	8.92	0.20	-92	0.13
13	1.14	8.45	0.26	-46	0.21
14	1.24	8.12	0.36	-16	0.32
15	1.37	8.08	0.48	4	0.44
16	1.51	8.11	0.59	19	0.60
17	1.68	7.97	0.64	34	0.79
18	1.89	7.59	0.70	51	1.15

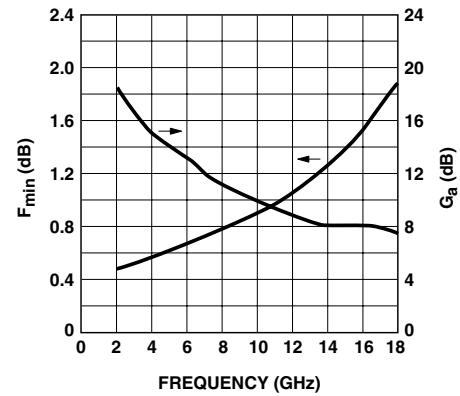

Figure 1. ATF-36163 Minimum Noise Figure and Associated Gain vs. Frequency for $V_{DS} = 1.5 \text{ V}$, $I_D = 10 \text{ mA}$.

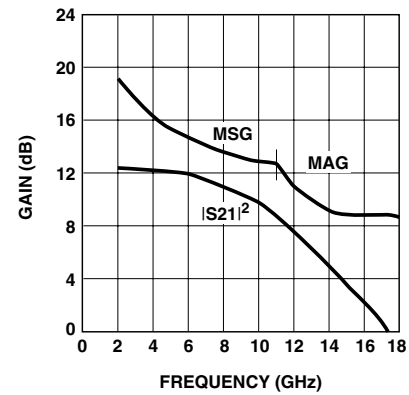

Figure 2. Maximum Available Gain, Maximum Stable Gain & Insertion Power Gain vs. Frequency for $V_{DS} = 1.5 \text{ V}$, $I_D = 10 \text{ mA}$.

ATF-36163 Typical Scattering Parameters, Common Source, $Z_0 = 50 \Omega$, $V_{DS} = 1.5 \text{ V}$, $I_D = 15 \text{ mA}$

Freq. GHz	S_{11}			S_{21}			S_{12}			S_{22}			K	$G_{max}^{[1]}$ dB
	Mag.	Ang.	dB	Mag.	Ang.	dB	Mag.	Ang.	Mag.	Ang.	Mag.	Ang.		
0.5	0.99	-12	13.56	4.76	168	-38.42	0.01	79	0.45	-9	0.12	25.82		
1	0.98	-22	13.40	4.68	157	-32.40	0.02	71	0.45	-18	0.18	22.86		
2	0.96	-43	13.16	4.55	137	-26.56	0.05	56	0.43	-36	0.26	19.87		
3	0.92	-63	13.00	4.47	116	-23.22	0.07	40	0.40	-52	0.35	18.13		
4	0.86	-85	12.87	4.40	96	-21.01	0.09	24	0.35	-70	0.46	16.94		
5	0.80	-108	12.68	4.30	75	-19.25	0.11	7	0.28	-92	0.55	15.98		
6	0.74	-133	12.38	4.16	53	-18.13	0.12	-11	0.21	-116	0.62	15.25		
7	0.66	-160	11.85	3.91	31	-17.39	0.14	-28	0.13	-146	0.74	14.62		
8	0.59	173	11.33	3.68	11	-16.95	0.14	-42	0.06	156	0.84	14.14		
9	0.56	141	10.74	3.44	-11	-16.54	0.15	-58	0.12	73	0.90	13.63		
10	0.56	106	9.89	3.12	-33	-16.42	0.15	-73	0.23	44	0.95	13.16		
11	0.59	74	8.74	2.74	-54	-16.83	0.14	-88	0.34	23	1.03	11.78		
12	0.63	49	7.59	2.40	-74	-17.39	0.14	-102	0.42	6	1.10	10.62		
13	0.68	25	6.29	2.06	-93	-18.42	0.12	-115	0.50	-10	1.19	9.72		
14	0.73	5	5.01	1.78	-110	-19.74	0.10	-124	0.57	-23	1.29	9.15		
15	0.79	-12	3.70	1.53	-127	-21.31	0.09	-133	0.64	-34	1.35	8.99		
16	0.83	-25	2.43	1.32	-144	-22.85	0.07	-139	0.68	-44	1.39	8.93		
17	0.87	-38	0.84	1.10	-163	-24.73	0.06	-148	0.73	-54	1.39	9.06		
18	0.91	-53	-1.33	0.86	180	-28.87	0.04	-155	0.78	-66	1.67	8.92		

Note:

1. $G_{max} = \text{MAG}$ for $K > 1$ and $G_{max} = \text{MSG}$ for $K \leq 1$.

ATF-36163 Typical Noise Parameters

Common Source, $Z_0 = 50 \Omega$, $V_{DS} = 1.5 \text{ V}$, $I_D = 15 \text{ mA}$

Freq. GHz	F_{min} dB	G_a dB	Γ_{opt}		R_n/Z_0 -
			Mag.	Ang.	
2	0.49	18.87	0.84	28	0.38
3	0.54	17.20	0.74	42	0.31
4	0.58	15.75	0.66	57	0.25
5	0.63	14.49	0.59	72	0.19
6	0.68	13.61	0.54	90	0.15
7	0.73	12.36	0.46	106	0.11
8	0.79	11.54	0.37	121	0.09
9	0.85	10.82	0.30	140	0.08
10	0.91	10.32	0.21	174	0.08
11	0.99	9.73	0.17	-133	0.10
12	1.07	9.22	0.20	-83	0.14
13	1.17	8.68	0.26	-40	0.22
14	1.27	8.41	0.38	-12	0.34
15	1.40	8.36	0.49	7	0.46
16	1.54	8.37	0.60	21	0.64
17	1.72	8.10	0.62	35	0.85
18	1.93	8.00	0.71	52	1.18

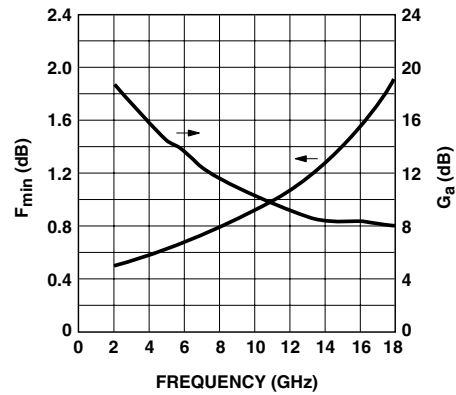

Figure 3. ATF-36163 Minimum Noise Figure and Associated Gain vs. Frequency for $V_{DS} = 1.5 \text{ V}$, $I_D = 15 \text{ mA}$.

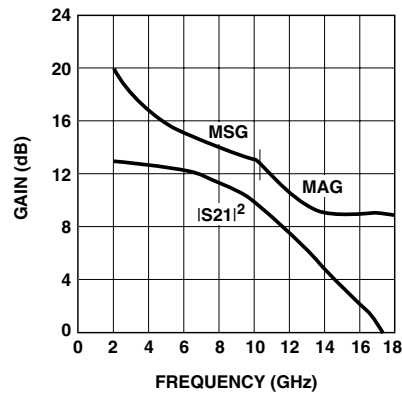

Figure 4. Maximum Available Gain, Maximum Stable Gain & Insertion Power Gain vs. Frequency for $V_{DS} = 1.5 \text{ V}$, $I_D = 15 \text{ mA}$.

ATF-36163 Typical Scattering Parameters, Common Source, $Z_0 = 50 \Omega$, $V_{DS} = 2.0 V$, $I_D = 10 mA$

Freq. GHz	S_{11}			S_{21}			S_{12}		S_{22}		K -	Gmax ^[1] dB
	Mag.	Ang.	dB	Mag.	Ang.	dB	Mag.	Ang.	Mag.	Ang.		
0.5	0.99	-11	13.06	4.50	168	-37.72	0.01	79	0.55	-9	0.11	25.46
1	0.99	-22	12.90	4.42	158	-32.04	0.03	71	0.55	-18	0.16	22.46
2	0.96	-42	12.69	4.31	138	-26.38	0.05	56	0.53	-35	0.24	19.50
3	0.93	-62	12.57	4.25	118	-22.97	0.07	40	0.50	-52	0.32	17.77
4	0.87	-83	12.51	4.22	97	-20.72	0.09	23	0.44	-70	0.42	16.61
5	0.81	-106	12.38	4.16	76	-18.94	0.11	6	0.38	-90	0.51	15.67
6	0.75	-131	12.15	4.05	55	-17.79	0.13	-12	0.31	-112	0.58	14.98
7	0.67	-157	11.70	3.84	33	-17.08	0.14	-30	0.21	-137	0.69	14.38
8	0.60	176	11.25	3.65	13	-16.65	0.15	-44	0.13	-168	0.79	13.96
9	0.57	144	10.73	3.44	-10	-16.25	0.15	-60	0.10	115	0.85	13.50
10	0.56	109	9.95	3.14	-32	-16.25	0.15	-76	0.18	61	0.91	13.10
11	0.58	77	8.86	2.77	-53	-16.77	0.15	-91	0.29	32	1.00	12.52
12	0.62	50	7.75	2.44	-73	-17.39	0.14	-104	0.37	12	1.08	10.82
13	0.67	26	6.49	2.11	-93	-18.56	0.12	-117	0.46	-5	1.19	9.85
14	0.72	6	5.24	1.83	-110	-19.91	0.10	-126	0.53	-19	1.31	9.24
15	0.78	-10	3.96	1.58	-128	-21.51	0.08	-134	0.60	-30	1.38	9.07
16	0.82	-24	2.68	1.36	-146	-23.10	0.07	-139	0.65	-40	1.42	9.03
17	0.87	-37	1.08	1.13	-165	-24.88	0.06	-147	0.71	-50	1.38	9.28
18	0.91	-52	-1.16	0.88	177	-28.64	0.04	-153	0.78	-63	1.63	9.06

Note:

1. $G_{max} = MAG$ for $K > 1$ and $G_{max} = MSG$ for $K \leq 1$.

ATF-36163 Typical Noise Parameters

Common Source, $Z_0 = 50 \Omega$, $V_{DS} = 2.0 V$, $I_D = 10 mA$

Freq. GHz	F_{min} dB	G_a dB	Γ_{opt}		R_n/Z_0 -
			Mag.	Ang.	
2	0.46	18.60	0.84	28	0.38
3	0.50	16.75	0.76	41	0.31
4	0.54	15.55	0.67	56	0.25
5	0.59	14.20	0.61	70	0.20
6	0.63	13.37	0.55	88	0.15
7	0.68	12.12	0.49	103	0.12
8	0.74	11.35	0.39	118	0.10
9	0.80	10.59	0.33	135	0.07
10	0.86	10.11	0.23	165	0.07
11	0.94	9.57	0.17	-145	0.09
12	1.02	9.08	0.18	-93	0.12
13	1.11	8.59	0.24	-47	0.19
14	1.22	8.30	0.34	-16	0.30
15	1.35	8.29	0.47	5	0.42
16	1.51	8.32	0.58	19	0.57
17	1.69	8.07	0.60	34	0.76
18	1.92	7.68	0.66	50	1.10

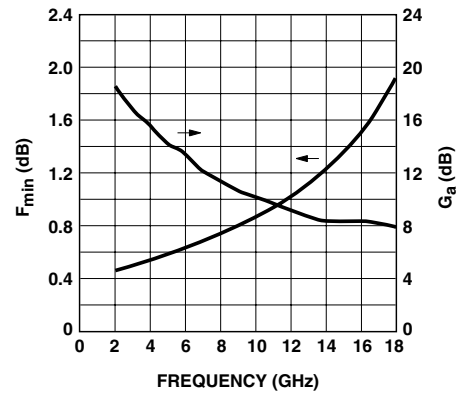

Figure 5. ATF-36163 Minimum Noise Figure and Associated Gain vs. Frequency for $V_{DS} = 2.0 V$, $I_D = 10 mA$.

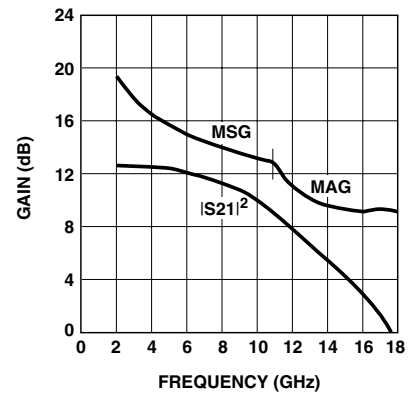

Figure 6. Maximum Available Gain, Maximum Stable Gain & Insertion Power Gain vs. Frequency for $V_{DS} = 2.0 V$, $I_D = 10 mA$.

ATF-36163 Typical Scattering Parameters, Common Source, $Z_0 = 50 \Omega$, $V_{DS} = 2 V$, $I_D = 15 \text{ mA}$

Freq. GHz	S_{11}			S_{21}			S_{12}			S_{22}		K	Gmax ^[1] dB
	Mag.	Ang.	dB	Mag.	Ang.	dB	Mag.	Ang.	Mag.	Ang.			
0.5	0.99	-12	13.85	4.93	168	-38.42	0.01	79	0.51	-9	0.12	26.10	
1	0.98	-22	13.70	4.84	157	-32.40	0.02	71	0.50	-18	0.17	23.11	
2	0.96	-43	13.45	4.70	137	-26.74	0.05	56	0.48	-35	0.26	20.13	
3	0.92	-63	13.29	4.62	117	-23.48	0.07	40	0.45	-52	0.35	18.40	
4	0.86	-85	13.16	4.55	96	-21.31	0.09	24	0.40	-69	0.46	17.22	
5	0.79	-108	12.96	4.45	75	-19.58	0.11	7	0.33	-90	0.55	16.26	
6	0.73	-133	12.67	4.30	53	-18.42	0.12	-10	0.26	-112	0.62	15.54	
7	0.65	-160	12.13	4.04	32	-17.72	0.13	-28	0.17	-136	0.75	14.93	
8	0.59	173	11.63	3.81	11	-17.27	0.14	-42	0.09	-171	0.84	14.46	
9	0.55	141	11.06	3.57	-11	-16.83	0.14	-57	0.09	93	0.90	13.95	
10	0.56	107	10.23	3.25	-32	-16.77	0.15	-72	0.19	51	0.96	13.50	
11	0.58	75	9.11	2.86	-53	-17.14	0.14	-87	0.30	27	1.04	11.93	
12	0.63	49	8.00	2.51	-73	-17.72	0.13	-99	0.38	9	1.11	10.85	
13	0.68	26	6.75	2.17	-92	-18.71	0.12	-112	0.47	-7	1.20	10.00	
14	0.73	6	5.49	1.88	-110	-20.00	0.10	-121	0.54	-20	1.30	9.45	
15	0.78	-11	4.22	1.63	-127	-21.41	0.09	-129	0.61	-31	1.35	9.30	
16	0.83	-24	2.99	1.41	-145	-22.73	0.07	-135	0.66	-41	1.36	9.31	
17	0.88	-38	1.42	1.18	-164	-24.44	0.06	-143	0.72	-51	1.31	9.56	
18	0.91	-52	-0.79	0.91	178	-27.96	0.04	-149	0.78	-63	1.50	9.44	

Note:

1. $G_{max} = \text{MAG}$ for $K > 1$ and $G_{max} = \text{MSG}$ for $K \leq 1$.

ATF-36163 Typical Noise Parameters

Common Source, $Z_0 = 50 \Omega$, $V_{DS} = 2.0 V$, $I_D = 15 \text{ mA}$

Freq. GHz	F_{min} dB	G_a dB	Γ_{opt}		R_n/Z_0 -
			Mag.	Ang.	
2	0.48	18.97	0.83	28	0.37
3	0.52	17.27	0.74	41	0.31
4	0.56	15.75	0.67	56	0.25
5	0.61	14.54	0.60	71	0.19
6	0.65	13.68	0.55	89	0.15
7	0.70	12.47	0.46	104	0.11
8	0.76	11.66	0.37	118	0.09
9	0.82	10.94	0.31	136	0.08
10	0.88	10.44	0.21	168	0.07
11	0.95	9.88	0.15	-137	0.09
12	1.03	9.38	0.18	-85	0.13
13	1.12	8.90	0.25	-41	0.21
14	1.23	8.63	0.36	-13	0.32
15	1.35	8.59	0.48	7	0.44
16	1.49	8.63	0.58	20	0.60
17	1.65	8.68	0.65	34	0.79
18	1.86	8.32	0.70	51	1.10

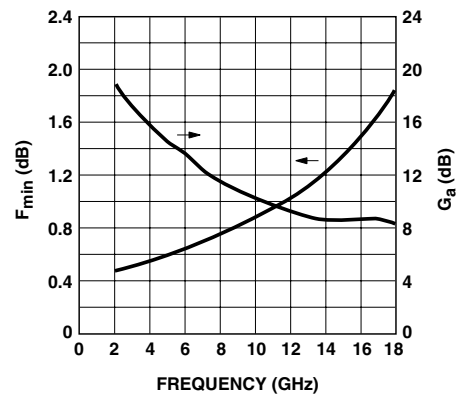

Figure 7. ATF-36163 Minimum Noise Figure and Associated Gain vs. Frequency for $V_{DS} = 2 V$, $I_D = 15 \text{ mA}$.

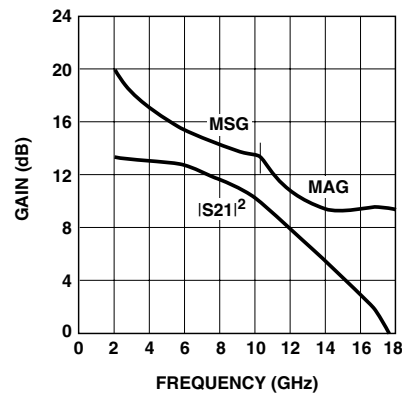

Figure 8. Maximum Available Gain, Maximum Stable Gain & Insertion Power Gain vs. Frequency for $V_{DS} = 2 V$, $I_D = 15 \text{ mA}$.

ATF-36163 Typical "Off" Scattering Parameters, Common Source, $Z_0 = 50 \Omega$, $V_{DS} = 0 V$, $V_{GS} = 0 V$

Freq. GHz	S_{11}			S_{21}			S_{12}		S_{22}	
	Mag.	Ang.	dB	Mag.	Ang.	dB	Mag.	Ang.	Mag.	Ang.
0.5	0.998	-10	-46.02	0.01	80	-46.02	0.01	86	0.703	170
1	0.993	-20	-39.17	0.01	81	-39.17	0.01	83	0.701	160
2	0.99	-37	-32.77	0.02	75	-32.77	0.02	76	0.70	139
3	0.98	-55	-28.64	0.04	67	-28.64	0.04	68	0.71	119
4	0.96	-74	-25.35	0.05	56	-25.19	0.06	57	0.73	99
5	0.94	-95	-22.62	0.07	42	-22.50	0.08	42	0.74	81
6	0.92	-118	-20.45	0.10	27	-20.45	0.10	27	0.75	63
7	0.89	-142	-18.79	0.12	11	-18.71	0.12	11	0.77	46
8	0.86	-168	-17.02	0.14	-6	-17.02	0.14	-5	0.78	30
9	0.84	162	-15.70	0.16	-24	-15.70	0.16	-24	0.81	16
10	0.83	128	-14.85	0.18	-44	-14.85	0.18	-44	0.83	3
11	0.83	94	-14.66	0.19	-64	-14.66	0.19	-64	0.84	-10
12	0.85	64	-14.85	0.18	-83	-14.85	0.18	-83	0.85	-22
13	0.86	36	-15.76	0.16	-101	-15.76	0.16	-101	0.87	-34
14	0.87	12	-17.14	0.14	-116	-17.08	0.14	-115	0.89	-44
15	0.90	-8	-18.71	0.12	-129	-18.71	0.12	-129	0.89	-53
16	0.93	-24	-20.45	0.10	-140	-20.45	0.10	-140	0.90	-62
17	0.93	-39	-23.35	0.07	-154	-23.10	0.07	-152	0.90	-71
18	0.93	-53	-27.96	0.04	-161	-28.18	0.04	-161	0.90	-81

ATF-36163 Typical "Off" Scattering Parameters, Common Source, $Z_0 = 50 \Omega$, $V_{DS} = 2.0 V$, $V_{GS} = -1.5 V$

Freq. GHz	S_{11}			S_{21}			S_{12}		S_{22}	
	Mag.	Ang.	dB	Mag.	Ang.	dB	Mag.	Ang.	Mag.	Ang.
0.5	0.97	-8	-34.89	0.02	82	-34.89	0.02	81	0.999	-7
1	0.98	-16	-28.87	0.04	74	-28.87	0.04	73	0.998	-14
2	0.99	-30	-22.85	0.07	59	-22.97	0.07	59	0.995	-29
3	0.98	-43	-19.33	0.11	44	-19.33	0.11	44	0.98	-43
4	0.97	-57	-16.71	0.15	29	-16.71	0.15	30	0.97	-57
5	0.96	-72	-14.42	0.19	14	-14.47	0.19	14	0.95	-74
6	0.94	-87	-12.62	0.23	-2	-12.65	0.23	-2	0.94	-91
7	0.92	-103	-10.90	0.29	-20	-10.96	0.28	-20	0.92	-107
8	0.89	-119	-9.60	0.33	-37	-9.63	0.33	-37	0.89	-125
9	0.85	-136	-8.09	0.39	-56	-8.09	0.39	-56	0.83	-148
10	0.79	-158	-6.73	0.46	-79	-6.73	0.46	-79	0.79	-174
11	0.74	177	-5.85	0.51	-106	-5.87	0.51	-106	0.75	156
12	0.72	149	-5.71	0.52	-136	-5.71	0.52	-136	0.73	123
13	0.71	114	-6.54	0.47	-170	-6.52	0.47	-170	0.74	86
14	0.75	74	-8.95	0.36	155	-8.92	0.36	156	0.79	50
15	0.82	35	-12.80	0.23	123	-12.69	0.23	123	0.85	18
16	0.89	5	-18.49	0.12	94	-18.20	0.12	95	0.90	-8
17	0.91	-21	-24.88	0.06	79	-24.44	0.06	84	0.91	-30
18	0.92	-42	-27.54	0.04	70	-27.96	0.04	69	0.90	-50

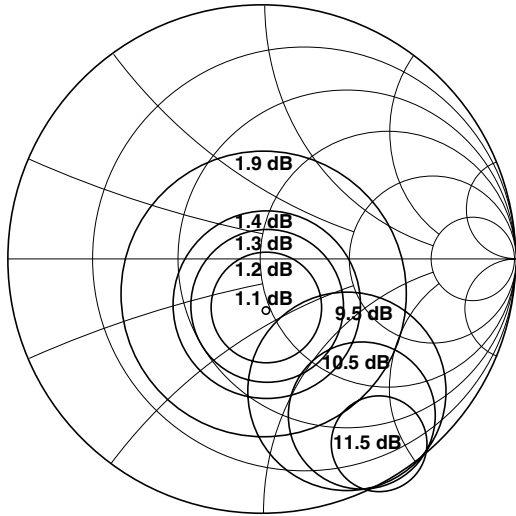

Figure 9. Smith Chart with Noise Figure and Available Gain Circles at 12 GHz, $V_{DS} = 1.5$ V, $I_D = 10$ mA.

Phase Reference Planes

The positions of the reference planes used to measure S-Parameters and to specify Γ_{opt} for the Noise Parameters are shown in Figure 10. As seen in the illustration, the reference planes are located at the extremities of the package leads.

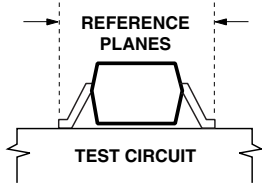

Figure 10. Reference Planes.

SOT-363 PCB Layout

A PCB pad layout for the miniature SOT-363 (SC-70) package used by the ATF-36163 is shown in Figure 11 (dimensions are in inches). This layout provides ample allowance for package placement by automated assembly equipment. The layout is shown with a nominal SOT-363 package footprint superimposed on the PCB.

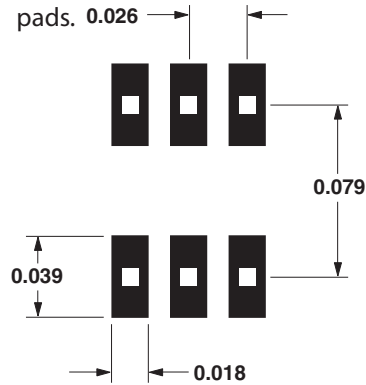
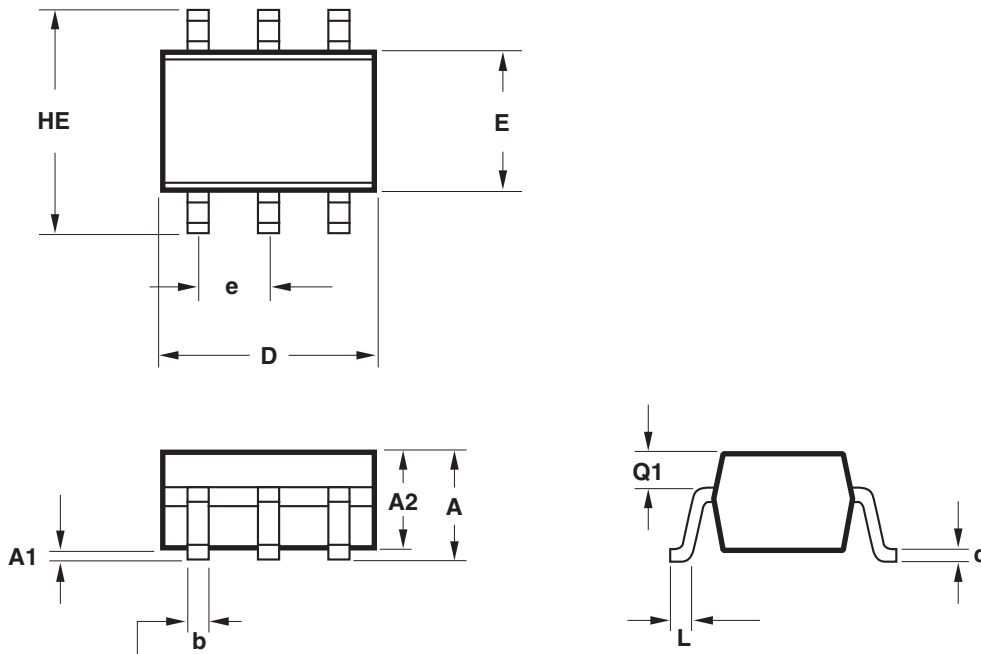

Figure 11. Recommended PCB Pad Layout for Avago's SC70 6L/SOT-363 Products (Dimensions in Inches).

Package Dimensions

SC-70 6L/SOT-363



SYMBOL	DIMENSIONS (mm)	
	MIN.	MAX.
E	1.15	1.35
D	1.80	2.25
HE	1.80	2.40
A	0.80	1.10
A2	0.80	1.00
A1	0.00	0.10
Q1	0.10	0.40
e	0.650 BCS	
b	0.15	0.30
c	0.10	0.20
L	0.10	0.30

NOTES:

1. All dimensions are in mm.
2. Dimensions are inclusive of plating.
3. Dimensions are exclusive of mold flash & metal burr.
4. All specifications comply to EIAJ SC70.
5. Die is facing up for mold and facing down for trim/form, ie: reverse trim/form.
6. Package surface to be mirror finish.

Part Number Ordering Information

Part Number	No. of Devices	Container
ATF-36163-TR1G	3000	7" Reel
ATF-36163-TR2G	10000	13" Reel
ATF-36163-BLKG	100	antistatic bag

Device Orientation

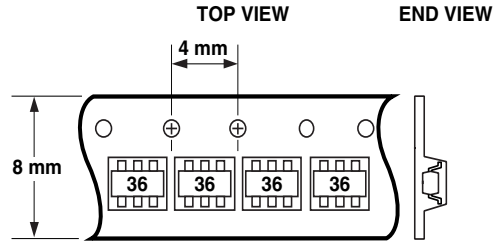
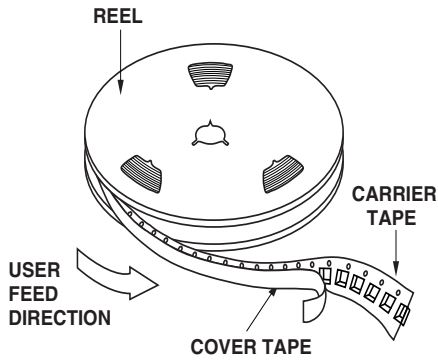

Tape Dimensions and Product Orientation For Outline 63

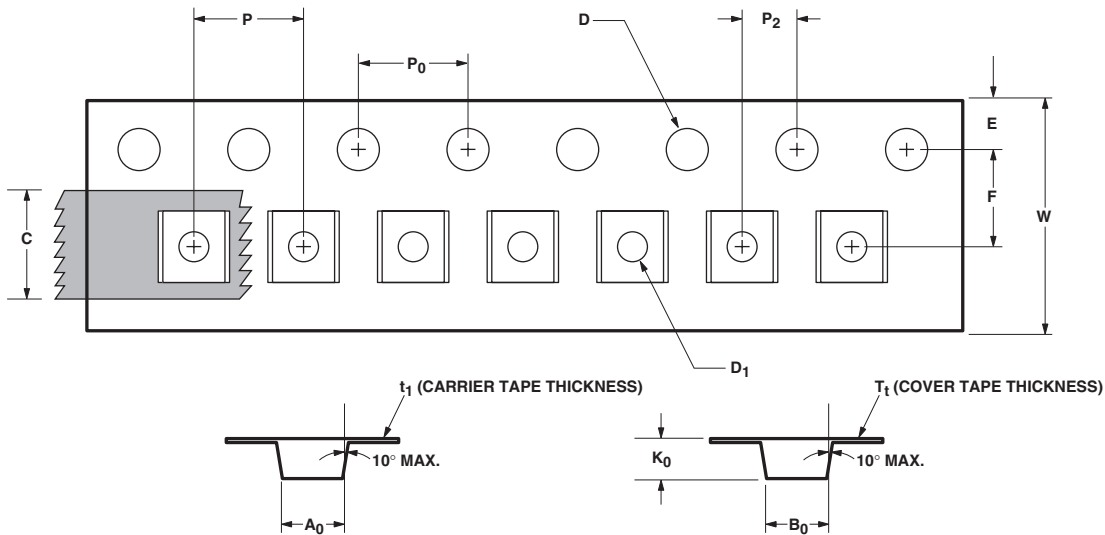

	DESCRIPTION	SYMBOL	SIZE (mm)	SIZE (INCHES)
CAVITY	LENGTH	A ₀	2.40 ± 0.10	0.094 ± 0.004
	WIDTH	B ₀	2.40 ± 0.10	0.094 ± 0.004
	DEPTH	K ₀	1.20 ± 0.10	0.047 ± 0.004
	PITCH	P	4.00 ± 0.10	0.157 ± 0.004
	BOTTOM HOLE DIAMETER	D ₁	1.00 ± 0.25	0.039 ± 0.010
PERFORATION	DIAMETER	D	1.55 ± 0.10	0.061 ± 0.002
	PITCH	P ₀	4.00 ± 0.10	0.157 ± 0.004
	POSITION	E	1.75 ± 0.10	0.069 ± 0.004
CARRIER TAPE	WIDTH	W	8.00 ± 0.30 - 0.10	0.315 ± 0.012
	THICKNESS	t ₁	0.254 ± 0.02	0.0100 ± 0.0008
COVER TAPE	WIDTH	C	5.40 ± 0.10	0.205 ± 0.004
	TAPE THICKNESS	T _t	0.062 ± 0.001	0.0025 ± 0.0004
DISTANCE	CAVITY TO PERFORATION (WIDTH DIRECTION)	F	3.50 ± 0.05	0.138 ± 0.002
	CAVITY TO PERFORATION (LENGTH DIRECTION)	P ₂	2.00 ± 0.05	0.079 ± 0.002

For product information and a complete list of distributors, please go to our web site: www.avagotech.com

Avago, Avago Technologies, and the A logo are trademarks of Avago Technologies in the United States and other countries. Data subject to change. Copyright © 2005-2008 Avago Technologies. All rights reserved. Obsoletes 5989-1915EN AV02-1441EN - July 29, 2008

Avago
TECHNOLOGIES