

MIHW3000 Series

5-6W, Ultra-High Isolation DIP, Single & Dual Output DC/DC Converters



Key Features



- Efficiency up to 80%
- 2:1 Wide Input Range
- 5600VDC Isolation
- Complies With EN55022 Class A
with external coupling capacitor $C_{io}=1\text{ nF} < \text{Class B}$
- Low Leakage Current
- Low Isolation Capacitance
- All I/O Clearance and Creepage Distance 2.0 mm Min.
- Temperature Performance -40°C to $+55^{\circ}\text{C}$
- MTBF > 700,000 Hours
- UL60950-1 Safety Approval

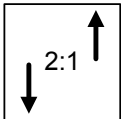

Wide Range



EN55022

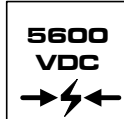

I/O Isolation

Minmax's MIHW3000-Series power modules are specially designed to provide ultra-high levels of isolation 5600VDC in a 24-pin DIP package. Operating input voltage ranges of 9-18VDC, 18-36VDC and 36-75VDC which provide precisely regulated output voltages of 5V, 12V, $\pm 12\text{V}$ and $\pm 15\text{VDC}$.

The -40°C to $+55^{\circ}\text{C}$ operating temperature range makes it ideal for data communication equipments, mobile battery driven equipments, distributed power systems, telecommunication equipments, mixed analog/digital subsystems, process/machine control equipments, computer peripheral systems and industrial robot systems.

The modules have a maximum power rating of 6W and a typical full-load efficiency of 80%, continuous short circuit, EN55022 Class A conducted noise compliance minimize design-in time, cost and eliminate the need for external filtering. Conducted and radiated emissions < A with external coupling capacitor $C_{io}=1\text{ nF} < \text{B}$.

Absolute Maximum Ratings

Parameter	Min.	Max.	Unit	
Input Surge Voltage (1000 mS)	12VDC Input Models	-0.7	25	VDC
	24VDC Input Models	-0.7	50	VDC
	48VDC Input Models	-0.7	100	VDC
Lead Temperature (1.5mm from case for 10 Sec.)	---	260	$^{\circ}\text{C}$	
Internal Power Dissipation	---	2,500	mW	

Exceeding the absolute maximum ratings of the unit could cause damage. These are not continuous operating ratings.

Environmental Specifications

Parameter	Conditions	Min.	Max.	Unit
Operating Temperature	Ambient	-40	+55	$^{\circ}\text{C}$
Operating Temperature	Case	-40	+95	$^{\circ}\text{C}$
Storage Temperature		-40	+125	$^{\circ}\text{C}$
Humidity		---	95	%
Cooling	Free-Air Convection			
Conducted EMI	EN55022 Class A			

Model Selection Guide

Model Number	Input Voltage	Output Voltage	Output Current		Input Current		Reflected Ripple Current	Efficiency
			Max.	Min.	@Max. Load	@No Load		@Max. Load
	VDC	VDC	mA	mA	mA (Typ.)	mA (Typ.)	mA (Typ.)	% (Typ.)
MIHW3022	12 (9 ~ 18)	5	1000	200	570	30	60	75
MIHW3023		12	500	100	641			78
MIHW3026		±12	±250	±50	641			78
MIHW3027		±15	±200	±40	641			78
MIHW3032	24 (18 ~ 36)	5	1000	200	278	20	30	77
MIHW3033		12	500	100	313			80
MIHW3036		±12	±250	±50	313			80
MIHW3037		±15	±200	±40	313			80
MIHW3042	48 (36 ~ 75)	5	1000	200	139	10	15	77
MIHW3043		12	500	100	156			80
MIHW3046		±12	±250	±50	156			80
MIHW3047		±15	±200	±40	156			80

Capacitive Load

Models by Vout	5V	12V	±12V #	±15V #	Unit
Maximum Capacitive Load	1000	470	220	220	µF

For each output

Input Fuse Selection Guide

12V Input Models	24V Input Models	48V Input Models
1200mA Slow – Blow Type	600mA Slow – Blow Type	300mA Slow – Blow Type

Input Specifications

Parameter	Model	Min.	Typ.	Max.	Unit
Start Voltage	12V Input Models	7	8	9	VDC
	24V Input Models	13	15	18	
	48V Input Models	30	33	36	
Under Voltage Shutdown	12V Input Models	---	---	8.5	
	24V Input Models	---	---	16	
	48V Input Models	---	---	34	
Short Circuit Input Power	All Models	---	---	3000	mW
Input Filter		Pi Filter			

Output Specifications

Parameter	Conditions	Min.	Typ.	Max.	Unit
Output Voltage Accuracy		---	± 0.5	± 1.0	%
Output Voltage Balance	Dual Output, Balanced Loads	---	± 0.5	± 2.0	%
Line Regulation	$V_{in} = \text{Min. to Max.}$	---	± 0.3	± 0.5	%
Load Regulation	$I_o = 100\% \text{ to } 25\%$	---	± 0.5	± 1.0	%
Ripple & Noise (20MHz)	5V Output Models	---	75	100	mV P-P
	Other Output Models	---	100	150	mV P-P
Ripple & Noise (20MHz)	Over Line, Load & Temp.	---	---	180	mV P-P
Ripple & Noise (20MHz)		---	---	25	mV rms
Over Load		120	---	---	%
Transient Recovery Time	25% Load Step Change	---	300	500	μS
Transient Response Deviation		---	± 3	± 6	%
Temperature Coefficient		---	± 0.02	± 0.05	%/°C
Output Short Circuit	Continuous				

General Specifications

Parameter	Conditions	Min.	Typ.	Max.	Unit
Isolation Voltage Rated	60 Seconds	5600	---	---	VDC
Isolation Voltage Test	Flash Tested for 1 Second	6000	---	---	VDC
Leakage Current	240VAC, 60Hz	---	---	2	μA
Isolation Resistance	500VDC	1000	---	---	M Ω
Isolation Capacitance	100KHz, 1V	---	7	13	pF
Switching Frequency		---	150	---	KHz
MTBF	MIL-HDBK-217F @ 25°C, Ground Benign	700	---	---	K Hours

Notes :

1. Specifications typical at $T_a = +25^\circ\text{C}$, resistive load, nominal input voltage, rated output current unless otherwise noted.
2. Transient recovery time is measured to within 1% error band for a step change in output load of 75% to 100%.
3. Ripple & Noise measurement bandwidth is 0–20 MHz.
4. These power converters require a minimum output loading to maintain specified regulation.
5. Operation under no-load conditions will not damage these modules; however, they may not meet all specifications listed.
6. All DC/DC converters should be externally fused at the front end for protection.
7. Other input and output voltage may be available, please contact factory.
8. Specifications subject to change without notice.

Block Diagram

Single Output

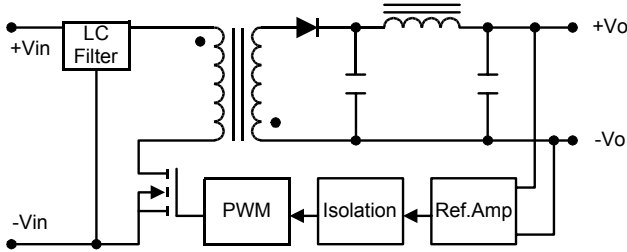

Dual Output

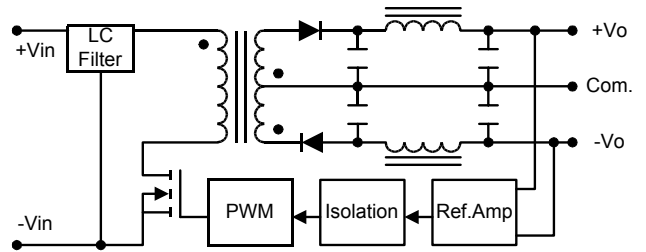

Input Voltage Transient Rating

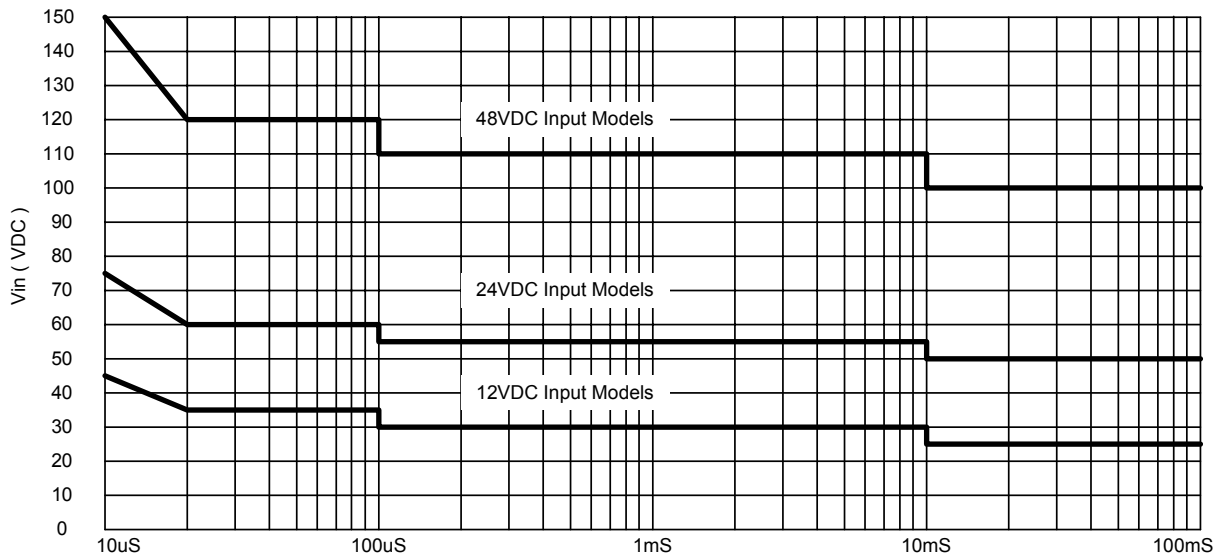

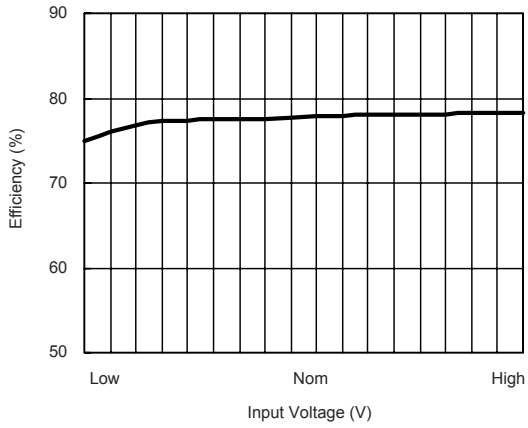

Efficiency vs Input Voltage (Single Output)

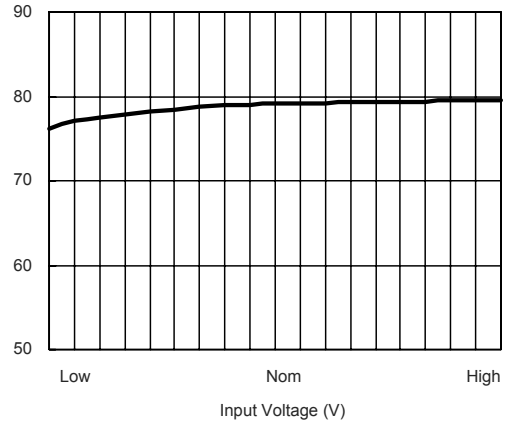

Efficiency vs Input Voltage (Dual Output)

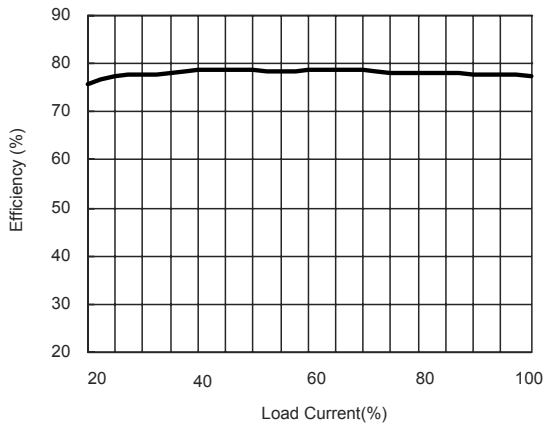

Efficiency vs Output Load (Single Output)

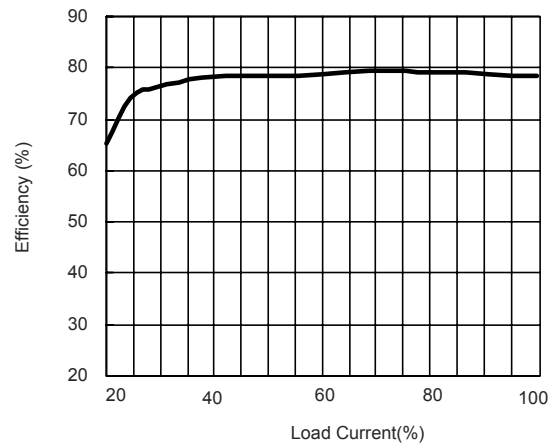

Efficiency vs Output Load (Dual Output)

Test Configurations

Input Reflected-Ripple Current Test Setup

Input reflected-ripple current is measured with an inductor L_{in} (4.7uH) and C_{in} (220uF, ESR < 1.0Ω at 100 kHz) to simulated source impedance.

Capacitor C_{in} , offsets possible battery impedance.

Current ripple is measured at the input terminals of the module, measurement bandwidth is 0–500KHz.

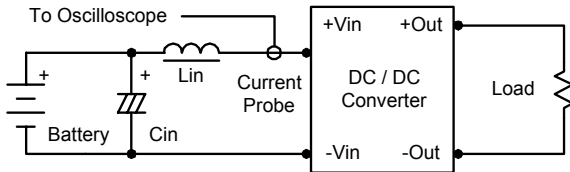

Peak-to-Peak Output Noise Measurement Test

Use a C_{out} 0.47uF ceramic capacitor.

Scope measurement should be made by using a BNC socket, measurement bandwidth is 0–20 MHz. Position the load between 50 mm and 75 mm from the DC/DC Converter.

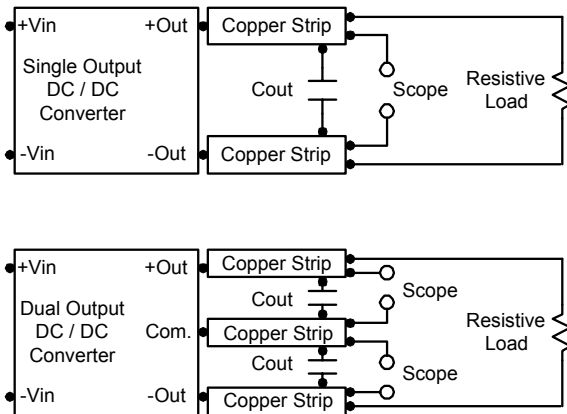

Design & Feature Considerations

Maximum Capacitive Load

The MIHW3000 series has limitation of maximum connected capacitance on the output.

The power module may operate in current limiting mode during start-up, affecting the ramp-up and the startup time.

Connect capacitors at the point of load for best performance.

The maximum capacitance can be found in the data sheet.

Input Source Impedance

The power module should be connected to a low ac-impedance input source. Highly inductive source impedances can affect the stability of the power module.

In applications where power is supplied over long lines and output loading is high, it may be necessary to use a capacitor on the input to insure startup.

By using a good quality low Equivalent Series Resistance (ESR < 1.0Ω at 100 kHz) capacitor of a 10uF for the 12V input devices and a 4.7uF for the 24V input devices and a 2.2uF for the 48V devices, capacitor mounted close to the power module helps ensure stability of the unit.

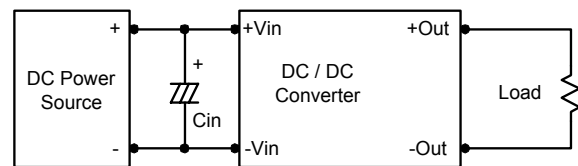

Output Ripple Reduction

A good quality low ESR capacitor placed as close as practicable across the load will give the best ripple and noise performance.

To reduce output ripple, it is recommended that 3.3uF capacitors are used on output.

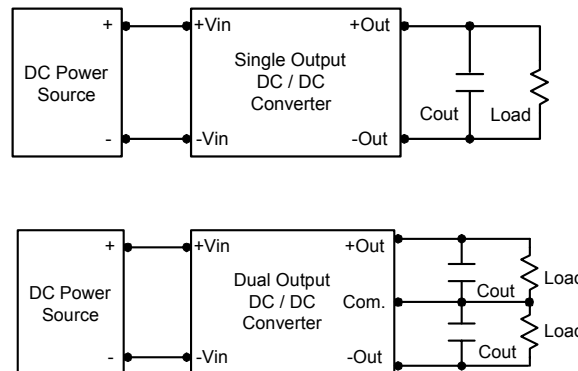

MIHW3000 Series

Thermal Considerations

Many conditions affect the thermal performance of the power module, such as orientation, airflow over the module, and board spacing. To avoid exceeding the maximum temperature rating of the components inside the power module, the case temperature must be kept below 95°C.

The derating curves were determined from measurements obtained in an experimental apparatus.

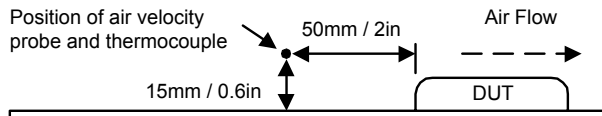

Electromagnetic emission EN 55022 < A

Conducted and radiated emissions < A
with external coupling capacitor $C_{io}=1$ nF < B

Mechanical Dimensions

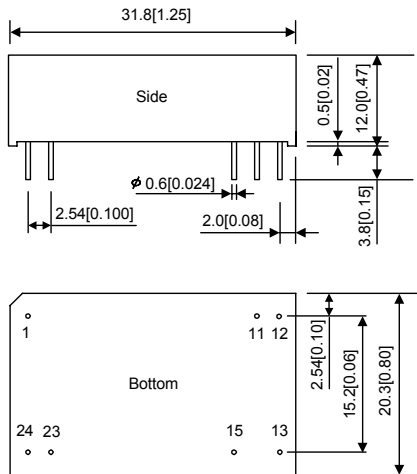

Physical Characteristics

- Case Size** : 31.8×20.3×12.0 mm
1.25×0.8×0.47 inches
- Case Material** : Non-Conductive Black Plastic
- Weight** : 18g
- Flammability** : UL94V-0

Tolerance	Millimeters	Inches
	X.X±0.25	X.XX±0.01
	X.XX±0.13	X.XXX±0.005
Pin	±0.05	±0.002

Pin Connections

Pin	Single Output	Dual Output
1	+Vin	+Vin
11	No Pin	Common
12	-Vout	No Pin
13	+Vout	-Vout
15	No Pin	+Vout
23	-Vin	-Vin
24	-Vin	-Vin