

# MHF+ Single, Dual and Triple DC/DC Converters

## 28 VOLT INPUT – 15 WATT

### FEATURES

- –55° to +125°C operation
- 16 to 40 VDC input (16 to 48 VDC triple)
- Fully isolated
- Optocoupler feedback
- Fixed frequency 550 kHz typical
  - 450 kHz triple models
- Topology
  - Single and dual: Single Ended Forward
  - Triple: Current Mode Flyback
- Transient protection
  - Single and dual: 50 V/50 ms
  - Triple: 80 V/120 ms
- Inhibit and sync functions
- Indefinite short circuit protection
- Undervoltage lockout
- Up to 84% efficiency, 28 W/in<sup>3</sup>
  - Up to 76% efficiency triple models



### MODELS

#### VDC OUTPUT

SINGLE	DUAL	TRIPLE
3.3	±5	+5 & ±12
5	±12	+5 & ±15
5.2	±15	
12		
15		
28		

### MHF+ SERIES™ SINGLE & DUAL DC/DC CONVERTERS

The MHF+ Single and Dual Series™ of high frequency DC/DC converters offers a wide input voltage range of 16 to 40 volts and up to 15 watts of output power. The units are capable of withstanding short term transients up to 50 volts. The package is a hermetically sealed, welded metal case. Flanged and non-flanged models are available.

### CONVERTER DESIGN

The MHF+ converters are switching regulators that use a quasi-square wave, single-ended forward converter design with a constant switching frequency of 550 kHz. Isolation between input and output circuits is provided with a transformer in the forward path and a temperature compensated optical link in the feedback control loop.

For the MHF+ dual output models, good cross regulation is maintained by tightly coupled output magnetics. Up to 90% of the total output power (80% on 2805D) is available from either output, providing the opposite output is simultaneously carrying 10% of the total output power (20% on 2805D models). Predictable current limit is accomplished by directly monitoring the output load current and providing a constant current output above the overload point.

### HIGHER POWER DENSITY

The MHF+ Series offers a new standard of performance for small size and high power density. At just 0.33 inch high and a total footprint of 1.7 in<sup>2</sup>, this low profile package offers a total power density of up to 28 watts per cubic inch.

### LOW NOISE, HIGH AUDIO REJECTION

The MHF+ converters' feed-forward compensation system provides excellent dynamic response and noise rejection. Audio rejection is typically 50 dB. Typical output voltage response for a 50% to 100% step load transient is as low as 1.3% with a 150 msec recovery time. Input ripple current is typically 35 mA p-p with output ripple voltage typically 30 mV p-p.

### INHIBIT FUNCTION

MHF+ converters provide an inhibit terminal that can be used to disable internal switching, resulting in no output and very low quiescent input current. The converter is inhibited when a TTL compatible low ( $\leq 0.8$  – output disabled) is applied to the inhibit pin. The unit is enabled when the pin, which is internally connected to a pull-up resistor, is left unconnected or is connected to an open-collector gate. The open circuit output voltage associated with the inhibit pin is 8.5 to 12 V. In the inhibit mode, a maximum of 4 mA must be sunk from the inhibit pin.

# MHF+ Single, Dual and Triple DC/DC Converters

## 28 VOLT INPUT – 15 WATT

### SYNCHRONIZATION

A synchronization feature is included with the MHF+ Series that allows the user to match the switching frequency of the converter to the frequency of the system clock. An external synchronization feature is included that allows the user to adjust the nominally 550 kHz operating frequency to any frequency within the range of 500 kHz to 600 kHz. This is initiated by applying a TTL compatible input of the desired frequency to pin 5.

### SHORT CIRCUIT PROTECTION

MHF+ Series converters provide short circuit protection by restricting the output current to approximately 115% of the full load output current. The output current is sensed in the secondary stage to provide highly predictable and accurate current limiting, and to eliminate foldback characteristics.

### UNDERVOLTAGE LOCKOUT

Undervoltage lockout prevents the units from operating below approximately 14 VDC input voltage to keep system current levels smooth, especially during initialization or re-start operations.

### MHF+ SERIES™ TRIPLE DC/DC CONVERTERS

MHF+ Series™ Triple DC/DC converters provide a wide input voltage range of 16 to 48 VDC delivering 15 watts of total output power with output voltages of +5 and  $\pm 12$  or +5 and  $\pm 15$  VDC. The main output, +5 VDC, will supply up to 7.5 watts and the auxiliaries will supply up to 7.5 watts of combined power. Full power operation at -55° C to +125° C plus the ability to withstand transients of up to 80 V for up to 120 milliseconds make these converters an ideal choice for your high reliability systems.

### CONVERTER DESIGN

MHF+ Triple Series of DC/DC converters incorporate dual-phase, phase-shifted technology with a continuous flyback topology. This design eliminates a minimum load requirement on the main output and eliminates cross regulation effects between the main output voltage and the auxiliary output voltages. The phase-shifted design offers a further benefit in reduced input and output ripple.

### INHIBIT FUNCTION

An open collector, TTL compatible, inhibit terminal (pin 1) provides shut-down and start-up control. Applying a logic level low (<0.8 V), referenced to input common, will disable the output of the converter. When inhibited input current is reduced to 5 mA or less and there is no generation of switching noise. The inhibit terminal typically sinks 3 mA when the converter is inhibited.

Leaving the terminal open or pulling it high will enable the converter. Use an open collector interface for logic high voltages of up to 11 volts. (Refer to Figure 2 for a connection diagram.) An open collector interface is not required if the logic high is in excess of the open circuit voltage of the inhibit terminal, 11 volts, but less than 40 volts.

### SOFT START FEATURE

The soft-start feature provides a controlled 20 milliseconds turn-on to minimize inrush current and reduce overshoot at initial start-up or when inhibit is released.

### SYNCHRONIZATION

To synchronize the converter's switching frequency to a system clock apply the clock signal to the sync terminal (pin 7). When multiple converters are powered from a single power source, asynchronous (free run) operation will result in lower peak noise for common spectral peaks, but synchronous operation will eliminate any possibility of interference frequencies in the low audio band. Source impedance of the signal should be less than 100 ohms and the transition time should be less than 100 nanoseconds. The capacitively coupled sync input will synchronize on a differential signal of as low as 4 volts to as high as 5 V. If the sync function is not used, the terminal should be left open.

### SHORT CIRCUIT PROTECTION

Internal current limiting circuitry protects all three outputs against short circuits. When output power exceeds approximately 130% of maximum output power, the output currents are limited. In addition, separate current limiting circuitry protects each output individually resulting in normal operation of either the main or the auxiliaries, whichever is not in a shorted condition.

### PACKAGING

MHF+ Triple converters are packaged in hermetically sealed metal cases. MHF+ Triple converters can be purchased in a flanged or non-flanged case. The flanged option provides increased heat dissipation and also provides greater stability when mechanically secured.

# MHF+ Single, Dual and Triple DC/DC Converters

28 VOLT INPUT – 15 WATT

## SIMPLIFIED SCHEMATIC DIAGRAMS

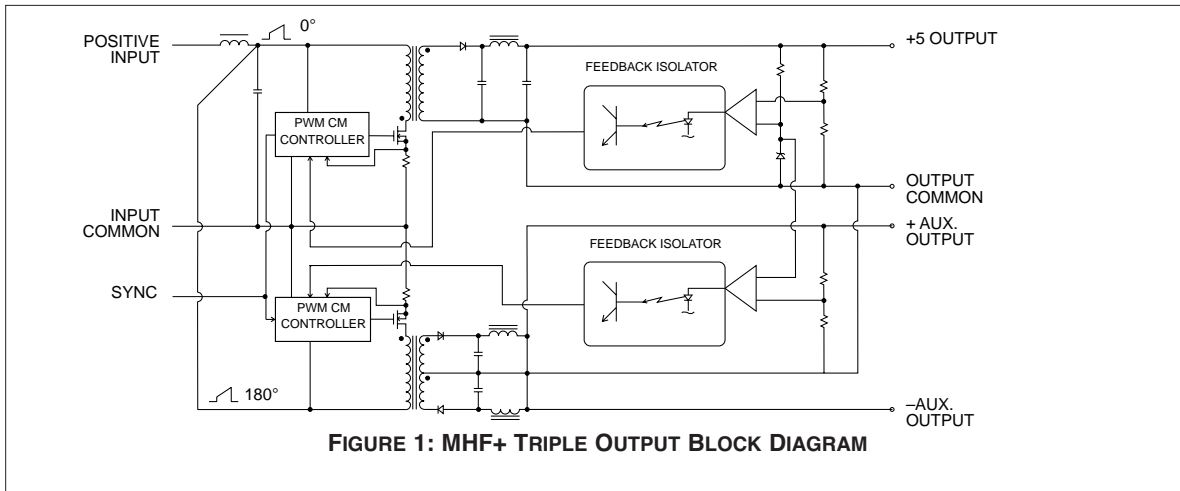
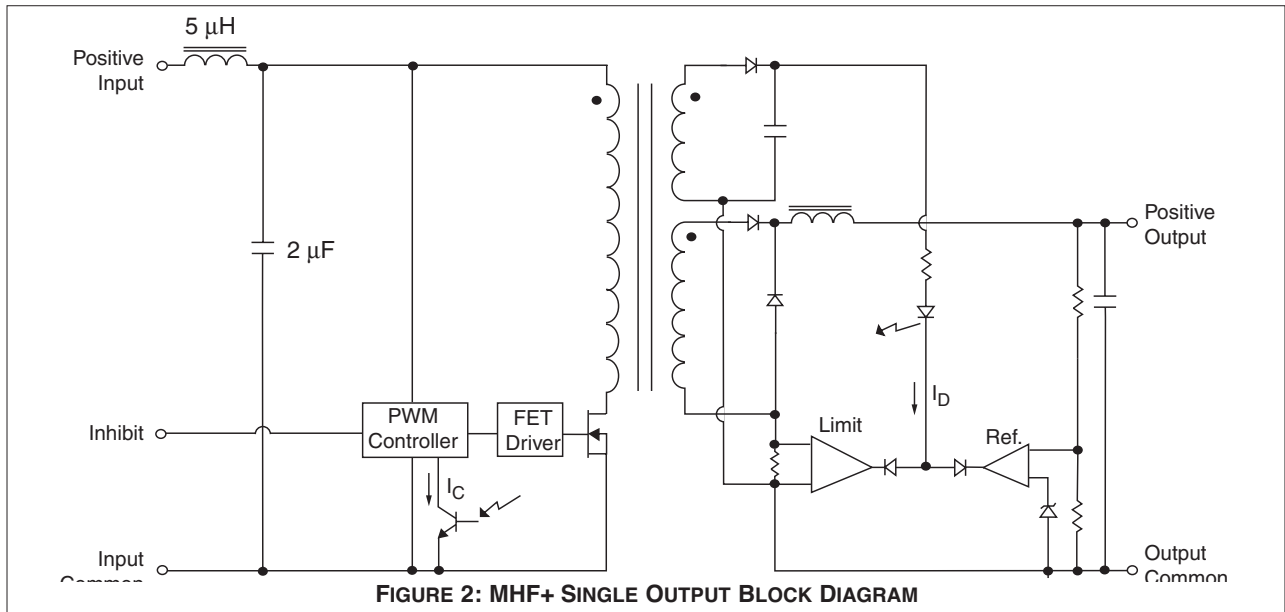

# MHF+ Single, Dual and Triple DC/DC Converters

## 28 VOLT INPUT – 15 WATT

### CONNECTION DIAGRAMS

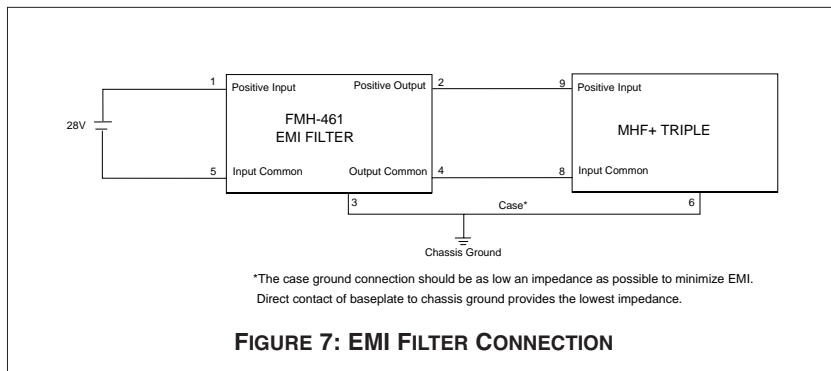
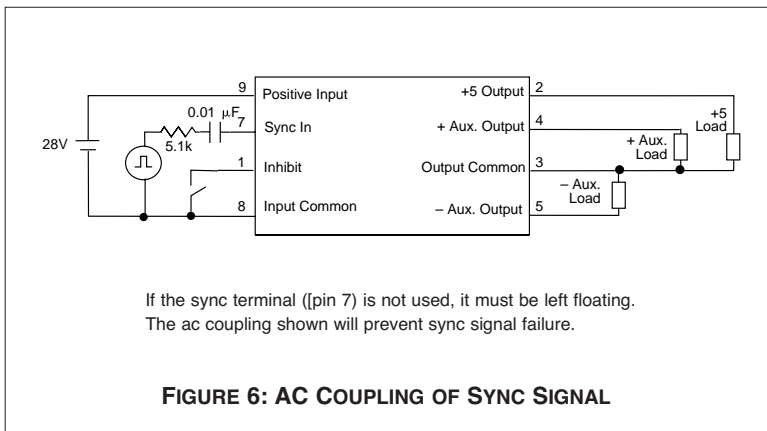
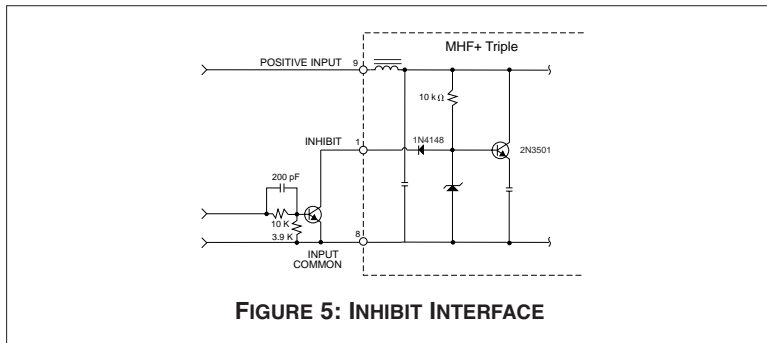

# MHF+ Single, Dual and Triple DC/DC Converters

## 28 VOLT INPUT – 15 WATT

### OPERATING CONDITIONS AND CHARACTERISTICS

#### Input Voltage Range

##### Single and dual models:

- 16 to 40 VDC continuous
- 50 V for up to 50 msec transient

##### Triple models:

- 16 to 48 VDC continuous
- 80 V for up to 120 msec

#### Output Power

- 12 to 15 watts depending on model

#### Power Dissipation (Pd)

- 6 watts single and dual, 12 watts triple

#### Lead Soldering Temperature (10 sec per pin)

- 300°C

#### Storage Temperature Range (Case)

- -65°C to +150°C

#### Case Operating Temperature (Tc)

- -55°C to +125°C full power
- -55°C to +135°C absolute

#### Derating Output Power/Current

- Linearly from 100% at 125°C to 0% at 135°C

#### Output Voltage Temperature Coefficient

- 100 ppm/°C typical
- 150 ppm/°C maximum

#### Input to Output Capacitance

- 60 pF typical

#### Current Limit

- 115% of full load typical (130% typical triple)

#### Isolation

- 100 megohm minimum at 500 V

#### Audio Rejection

- 50 dB typical

#### Conversion Frequency (55°C to +125°C Tc)

- Free run 550 kHz typical (375 minimum, 500 kHz maximum triple)
- External sync range 480 kHz min, 620 kHz max (400 to 600 kHz triple)

#### Inhibit Pin Voltage (unit enabled)

- 8.5 to 12 V, 10 V typical

#### Undervoltage Lockout

- 14 V input typical

### SYNC AND INHIBIT

#### Sync In (500 to 600 kHz single and dual, 400 to 600 kHz triple)

- Duty cycle 40% to 60%
- Logic low 0.8 V max
- Logic high 4 V min, 5 V max
- If not used, connect to input common (on triple models, leave unconnected)
- Referenced to input common

#### Sync Out - Referenced to input common

#### Inhibit: TTL Open Collector

- Logic low (output disabled)
  - Logic low voltage  $\leq 0.8$  V max
  - Inhibit pin current 4.0 mA max (3.0 typ, 5.0 max triple models)
- Referenced to input common
- Logic high (output enabled)
  - Open collector or unconnected (single and dual)
  - Unconnected or 11 to 40 V (triple)

### MECHANICAL AND ENVIRONMENTAL

#### Size (maximum)

- Non flanged 1.460 x 1.130 x 0.330 (37.08 x 28.70 x 8.38 mm)
- Flanged 2.005 x 1.130 x 0.330 (50.93 x 28.70 x 8.38 mm)
- See cases E1, E2, G1 and G2 for dimensions.

#### Weight (maximum)

- Single and dual models: 30 grams typical
- Triple models: 32 grams typical

#### Screening

- Standard, ES or 883 (Class H). See "883, Class H, QML Products – Element Evaluation" and "883, Class H, QML Products – Environmental Screening" for more information.

# MHF+ Single, Dual and Triple DC/DC Converters

## 28 VOLT INPUT – 15 WATT

### PIN OUT

Pin	Single Output (Except MHF+2828S)	MHF+2828S	Dual Output	Triple Output
1	Inhibit	Inhibit	Inhibit	Inhibit
2	No connection	Positive Output	Positive Output	Main (+5 V) Output
3	Output Common	(See note 1, below)	Output Common	Output Common
4	Positive Output	Output Common	Negative Output	Pos. Aux. Output
5	Sync	Sync	Sync	Neg. Aux. Output
6	Case Ground	Case Ground	Case Ground	Case Ground
7	Input Common	Input Common	Input Common	Sync In
8	Positive Input	Positive Input	Positive Input	Input Common
9	—	—	—	Positive Input

1. Pin 3 of MHF+2828S will provide 14 Vout referenced to output common (pin 4).

### PINS NOT IN USE

Inhibit single, dual and triple models, pin 1  
 MHF+2828S, pin 3  
 Sync single and dual models, pin 5  
 Sync In triple models, pin 7

Leave unconnected  
 Leave unconnected  
 Connect to input common  
 Leave unconnected

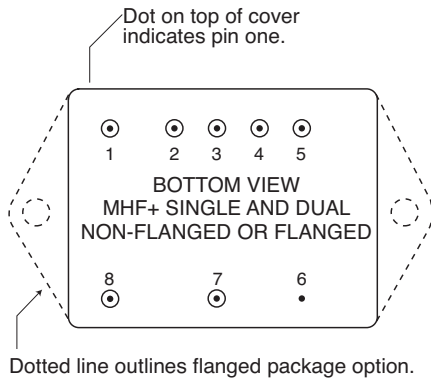

See cases E1 and E2 for dimensions.

FIGURE 3: MHF+ SINGLE AND DUAL PIN OUT

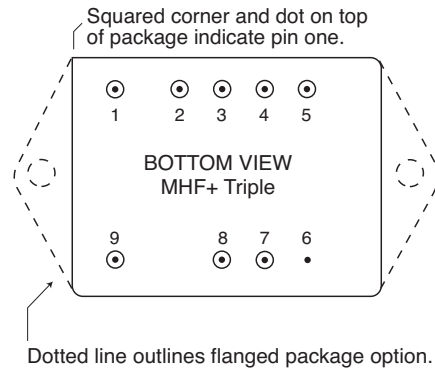

See cases E2 and G2 for dimensions.

FIGURE 4: MHF+ TRIPLE PIN OUT

# MHF+ Single, Dual and Triple DC/DC Converters

## 28 VOLT INPUT – 15 WATT

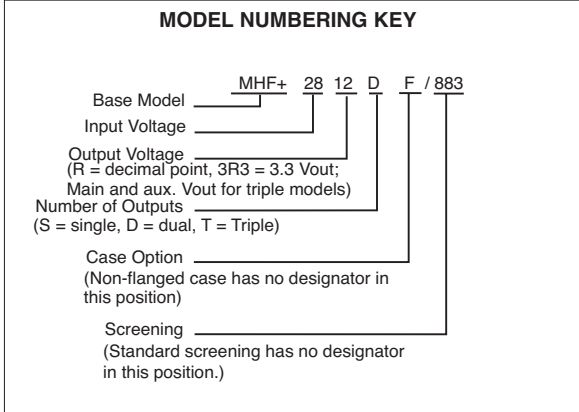

**SMD NUMBERS**

STANDARD MICROCIRCUIT DRAWING (SMD)	MHF+ SIMILAR PART
5962-0251001HXC	MHF+283R3S/883
5962-9213901HXC	MHF+2805S/883
5962-0325301HXC	MHF+285R2S/883
5962-9166401HXC	MHF+2812S/883
5962-9160101HXC	MHF+2815S/883
5962-9689801HXC	MHF+2828S/883
5962-955901HXC	MHF+2805D/883
5962-9214401HXC	MHF+2812D/883
5962-9161401HXC	MHF+2815D/883
5962-9560101HXC	MHF+28512T/883
5962-9560201HXC	MHF+28515T/883

Flanged SMDs have the suffix HZC instead of HXC.

For exact specifications for an SMD product, refer to the SMD drawing. SMDs can be downloaded from <http://www.dsccl.dla.mil/programs/smcr>

**Model Selection**

MHF+28  
Base model                                                          
Base model      Vout value      number of outputs      case option      screening

Choose one from each of the following rows

**Vout value**      singles: 3R3,5,5R2,12,15,28      duals: 5,12,15      triples\*: 512 or 515

---

*"R" = decimal point, 3R3 = 3.3VDC*

---

**Number of outputs**      S (single), D (dual) or T (triple)

---

**Case option**      non-flanged, leave blank      F - flanged

---

**Screening**      standard screening, leave blank      /ES (ES screening), /883 (Class H, QML)

---

\* for triple models "5" indicates the main voltage, "12" or "15" indicate the ± auxiliary voltages.

# MHF+ Single, Dual and Triple DC/DC Converters

## 28 VOLT INPUT – 15 WATT

Electrical Characteristics: 25°C Tc, 28 VDC Vin, 100% load, free run, unless otherwise specified.

SINGLE OUTPUT MODELS		MHF+283R3S			MHF+2805S			MHF+285R2S			UNITS
PARAMETER	CONDITION	MIN	TYP	MAX	MIN	TYP	MAX	MIN	TYP	MAX	
OUTPUT VOLTAGE		3.27	3.30	3.33	4.95	5.00	5.05	5.16	5.20	5.24	VDC
OUTPUT CURRENT	V <sub>IN</sub> = 16 to 40 VDC	0	—	2.4	0	—	2.4	0	—	2.4	A
OUTPUT POWER	V <sub>IN</sub> = 16 to 40 VDC	0	—	8	0	—	12	0	—	12.48	W
OUTPUT RIPPLE VOLTAGE	10 kHz - 2 MHz	—	30	80	—	30	80	—	30	50	mV p-p
	Tc = -55°C to +125°C	—	50	800	—	60	100	—	60	100	
LINE REGULATION	V <sub>in</sub> = 16 to 40 VDC	—	5	100	—	5	50	—	5	35	mV
LOAD REGULATION	NO LOAD TO FULL	—	20	50	—	20	50	—	20	35	mV
INPUT VOLTAGE	CONTINUOUS	16	28	40	16	28	40	16	28	40	VDC
NO LOAD TO FULL	TRANSIENT 50 ms	—	—	50	—	—	50	—	—	50	V
INPUT CURRENT	NO LOAD	—	25	40	—	25	40	—	25	42	mA
	INHIBITED	—	5	12	—	5	12	—	5	12	
INPUT RIPPLE CURRENT	10 kHz - 10 MHz	—	45	80	—	35	80	—	35	80	mApp
	Tc = -55°C to +125°C	—	—	120	—	—	100	—	—	120	
EFFICIENCY		70	75	—	75	77	—	75	77	—	%
LOAD FAULT <sup>1</sup>	SHORT CIRCUIT	—	—	—	—	—	—	—	—	—	W
	POWER DISSIPATION	—	5	8	—	3.5	6	—	3.5	6	
	RECOVERY <sup>2</sup>	—	7.5	30	—	7.5	30	—	7.5	30	ms
STEP LOAD RESP.	50% – 100% – 50%										mV pk
	TRANSIENT	-400	150	400	-400	150	400	-400	150	400	
	RECOVERY <sup>2</sup>	—	150	300	—	150	300	—	150	300	μs
STEP LINE RESP.	16 – 40 – 16 VDC										mV pk
	TRANSIENT <sup>3</sup>	-800	550	800	-800	550	800	-800	550	800	
	RECOVERY <sup>2</sup>	—	0.8	1.2	—	0.8	1.2	—	0.8	1.2	ms
START-UP	DELAY	—	10	25	—	10	25	—	10	25	ms
	OVERSHOOT <sup>4</sup>	—	200	300	—	100	600	—	100	600	mV pk
CAPACITIVE LOAD				300			300			300	μF

### Notes

1. Indefinite short circuit protection not guaranteed above 125°C (case)
2. Recovery time is measured from application of the transient to the point at which Vout is within regulation.
3. Input step transition time >10 μs.
4. Input step transition time <100 μs.



# MHF+ Single, Dual and Triple DC/DC Converters

## 28 VOLT INPUT – 15 WATT

Electrical Characteristics: 25°C Tc, 28 VDC Vin, 100% load, free run, unless otherwise specified.

SINGLE OUTPUT MODELS		MHF+2812S			MHF+2815S			MHF+2828S			UNITS
PARAMETER	CONDITION	MIN	TYP	MAX	MIN	TYP	MAX	MIN	TYP	MAX	
OUTPUT VOLTAGE		11.88	12.00	12.12	14.85	15.00	15.15	27.72	28.00	28.28	VDC
OUTPUT CURRENT	V <sub>IN</sub> = 16 to 40 VDC	0	—	1.25	0	—	1.00	0	—	0.54	A
OUTPUT POWER	V <sub>IN</sub> = 16 to 40 VDC	0	—	15	0	—	15	0	—	15	W
OUTPUT RIPPLE VOLTAGE	10 kHz - 2 MHz	—	30	80	—	30	80	—	60	120	mV p-p
	T <sub>c</sub> = -55°C to +125°C	—	50	120	—	50	120	—	100	180	
LINE REGULATION	V <sub>in</sub> = 16 to 40 VDC	—	5	50	—	5	50	—	50	150	mV
LOAD REGULATION	NO LOAD TO FULL	—	20	50	—	20	50	—	50	150	mV
INPUT VOLTAGE	CONTINUOUS	16	28	40	16	28	40	16	28	40	VDC
NO LOAD TO FULL	TRANSIENT 50 ms	—	—	50	—	—	50	—	—	50	V
INPUT CURRENT	NO LOAD	—	25	50	—	25	62	—	25	60	mA
	FULL LOAD	—	680	752	—	670	752	—	640	760	
	INHIBITED	—	5	12	—	5	12	—	5	12	
INPUT RIPPLE CURRENT	10 kHz - 10 MHz	—	35	80	—	35	80	—	35	80	mA pp
	T <sub>c</sub> = -55°C to +125°C	—	—	120	—	—	120	—	—	120	
EFFICIENCY		78	79	—	78	80	—	82	84	—	%
LOAD FAULT <sup>1</sup>	SHORT CIRCUIT										
	POWER DISSIPATION	—	3.5	6	—	3.5	6	—	3.5	6	W
	RECOVERY <sup>2</sup>	—	7.5	30	—	7.5	30	—	7.5	30	ms
STEP LOAD RESP.	50% – 100% – 50%										
	TRANSIENT	-500	150	500	-600	200	600	-800	600	800	mV pk
	RECOVERY <sup>2</sup>	—	150	300	—	150	300	—	200	400	μs
STEP LINE RESP.	16 – 40 – 40 VDC										
	TRANSIENT <sup>3</sup>	-800	550	800	-800	550	800	-1200	1100	1200	mV pk
	RECOVERY <sup>2</sup>	—	0.8	1.2	—	0.8	1.2	—	0.8	1.2	ms
START-UP	DELAY	0	10	25	0	10	25	0	10	25	ms
	OVERSHOOT <sup>4</sup>	0	200	1200	0	200	1500	0	200	280	mV pk

### Notes

- Indefinite short circuit protection not guaranteed above 125°C (case)
- Recovery time is measured from application of the transient to point at which V<sub>out</sub> is within regulation.
- Input step transition time >10 μs.
- Input step transition time <100 μs.

# MHF+ Single, Dual and Triple DC/DC Converters

## 28 VOLT INPUT – 15 WATT

Electrical Characteristics: 25°C Tc, 28 VDC Vin, 100% load, free run, unless otherwise specified.

DUAL OUTPUT MODELS		MHF+2805D			MHF+2812D			MHF+2815D			UNITS	
PARAMETER	CONDITIONS	MIN	TYP	MAX	MIN	TYP	MAX	MIN	TYP	MAX		
OUTPUT VOLTAGE	+V <sub>OUT</sub>	4.95	5.00	5.05	11.88	12.00	12.12	14.85	15.00	15.15	VDC	
	-V <sub>OUT</sub>	4.92	5.00	5.08	11.82	12.00	12.18	14.78	15.00	15.23		
OUTPUT CURRENT <sup>1</sup>	V <sub>IN</sub> = 16 to 40 VDC	—	±1.2	1.92	—	±0.625	1.125	—	±0.500	0.900	A	
OUTPUT POWER <sup>1</sup>	V <sub>IN</sub> = 16 to 40 VDC	—	—	12	—	—	15	—	—	15	W	
OUTPUT RIPPLE VOLTAGE ±V <sub>OUT</sub>	10 kHz - 2 MHz	—	30	80	—	30	80	—	30	80	mV p-p	
	Tc = -55°C to +125°C	—	60	120	—	60	120	—	50	120		
LINE REGULATION Vin = 16 to 40 VDC	BALANCED +V <sub>OUT</sub>	—	5	50	—	5	50	—	5	50	mV	
	LOAD -V <sub>OUT</sub>	—	—	80	—	—	100	—	—	100		
LOAD REGULATION	BALANCED +V <sub>OUT</sub>	—	20	50	—	20	50	—	20	50	mV	
	LOAD -V <sub>OUT</sub>	—	—	100	—	—	100	—	—	100		
CROSS REGULATION <sup>2</sup>	NEGATIVE V <sub>OUT</sub>	—	6	7.5	—	3	6	—	3	6	%	
INPUT VOLTAGE	CONTINUOUS	16	28	40	16	28	40	16	28	40	VDC	
NO LOAD TO FULL	TRANSIENT 50 msec	—	—	50	—	—	50	—	—	50	V	
INPUT CURRENT	NO LOAD	—	20	40	—	25	50	—	25	50	mA	
	FULL LOAD	—	540	600	—	645	754	—	638	754		
	INHIBITED	—	6	12	—	5	12	—	5	12		
INPUT RIPPLE CURRENT	10 kHz - 10 MHz	—	20	50	—	35	60	—	35	60	mA p-p	
	Tc = -55°C to +125°C	—	40	80	—	50	100	—	50	100		
EFFICIENCY		77	79	—	76	83	—	76	84	—	%	
LOAD FAULT	SHORT CIRCUIT <sup>3</sup>	—	—	—	—	—	—	—	—	—	W	
	POWER DISSIPATION	—	3	6	—	3	6	—	3	6		
	RECOVERY <sup>4</sup>	—	7.5	30	—	7.5	50	—	7.5	50		ms
STEP LOAD RESP. <sup>5</sup> BALANCED LOADS	50% – 100% – 50%	—	—	—	—	—	—	—	—	—	mV pk	
	TRANSIENT	+V <sub>OUT</sub>	-600	200	600	-600	300	600	-600	300		600
		-V <sub>OUT</sub>	-600	150	600	-600	100	600	-600	100		600
	RECOVERY <sup>4</sup>	—	150	500	—	200	400	—	200	500		μs
STEP LINE RESP. ± V <sub>OUT</sub>	16 – 40 – 40 VDC	—	—	—	—	—	—	—	—	—	mV pk	
	TRANSIENT <sup>6</sup>	-800	600	800	-750	550	750	-750	550	750		
	RECOVERY <sup>4</sup>	—	0.8	1.2	—	0.8	1.2	—	0.8	1.2		ms
START-UP	DELAY	—	12	20	—	12	25	—	12	25	ms	
	OVERSHOOT <sup>7</sup>	0	100	250	0	200	750	0	200	750	mV pk	

### Notes

- Up to 13.5 watts, 90% (9.6W, 80% for 2805D) of the total output power is available from either output providing the opposite output is simultaneously carrying 10% (20% for 2805D) of the total output power. Each output must carry a minimum of 10% (20% for 2805D) of the total output power in order to maintain regulation on the negative output.
- Effect on -Vout for the following conditions:  
+Po = 50% to 10% and -Po = 50%  
+Po = 50% and -Po = 50% to 10%
- Indefinite short circuit protection not guaranteed above 125°C (case)
- Recovery time is measured from application of the transient to point at which Vout is within regulation.
- Response of either output with the opposite output held at half of the total output power.
- Input step transition time >10 μs.
- Input step transition time <100 μs.

# MHF+ Single, Dual and Triple DC/DC Converters

## 28 VOLT INPUT – 15 WATT

Electrical Characteristics: 25°C Tc, 28 VDC Vin, 100% load, free run, unless otherwise specified.

TRIPLE OUTPUT MODELS		MHF+28512T			MHF+28515T			UNITS
PARAMETER	CONDITION	MIN	TYP	MAX	MIN	TYP	MAX	
OUTPUT VOLTAGE	MAIN	4.95	5.0	5.05	4.95	5.0	5.05	VDC
	+ AUXILIARY	11.64	12.0	12.36	14.55	15.0	15.45	
	- AUXILIARY	11.64	12.0	12.36	14.55	15.0	15.45	
OUTPUT CURRENT <sup>2</sup>	MAIN	0	—	1.5	0	—	1.5	A
	+ AUXILIARY	—	—	0.416	—	—	0.333	
	- AUXILIARY	—	—	0.416	—	—	0.333	
	TOTAL	—	—	2.125	—	—	2.0	
OUTPUT POWER <sup>3</sup>	MAIN	—	—	7.5	—	—	7.5	W
	+ AUXILIARY	—	—	5	—	—	5	
	- AUXILIARY	—	—	5	—	—	5	
	TOTAL	—	—	15	—	—	15	
OUTPUT RIPPLE VOLTAGE	10 kHz to 2 MHz MAIN	—	20	60	—	20	60	mV p-p
	10 kHz to 2 MHz ±AUXILIARY	—	30	90	—	30	112	
LINE REGULATION <sup>4</sup> VIN = MIN. TO MAX.	MAIN	—	25	75	—	25	75	mV
	±AUXILIARY	—	120	240	—	150	300	
LOAD REGULATION <sup>4, 5</sup>	MAIN	—	25	75	—	25	75	mV
	±AUXILIARY	—	120	240	—	150	300	
CROSS REGULATION <sup>6</sup>	- AUXILIARY	—	—	600	—	—	600	mV
INPUT VOLTAGE	CONTINUOUS	16	28	48	16	28	48	VDC
	TRANSIENT 120 ms <sup>1</sup>	—	—	80	—	—	80	V
INPUT CURRENT	NO LOAD -55 - +25°C	—	20	35	—	20	35	mA
	NO LOAD +125°C	—	30	45	—	30	45	
	INHIBITED <sup>4</sup>	—	3	5	—	3	5	
INPUT RIPPLE CURRENT	10 kHz to 10 MHz	—	20	50	—	20	50	mA p-p
EFFICIENCY		74	76	—	74	76	—	%
LOAD FAULT <sup>7</sup>	POWER DISSIPATION MAIN <sup>4</sup>	—	—	12	—	—	12	W
	±AUXILIARY	—	—	12	—	—	12	
STEP LOAD RESPONSE <sup>4, 8, 9</sup>	TRANSIENT MAIN	—	—	850	—	—	850	mV pk
	±AUXILIARY	—	—	950	—	—	950	
	RECOVERY MAIN	—	5	8	—	5	8	ms
	RECOVERY ±AUX.	—	2	3	—	2	3	
START-UP <sup>4</sup>	DELAY EACH OUTPUT	—	10	25	—	10	25	ms

### Notes

#### 1. Guaranteed, not tested

2. The sum of the 12 volt auxiliary output currents may not exceed 625 mA.

The sum of the 15 volt auxiliary output currents may not exceed 500 mA.

3. The sum of the auxiliary output power may not exceed 7.5 watts.

4. Case temperature -55°C to +125°C.

5. Load regulation for the +5 is specified at 0.0 to 1.5 A with the aux. both held at 3.76 W (313 mA for the ±12, 250 mA for the ±15). Load regulation for the aux. is specified as both aux. from 0.0 to 3.76 W (313 mA for ±12, 250 mA for ±15) at the same time with the +5 held at 1.5 A.

6. Cross regulation only occurs between the two auxiliaries and is measured on -aux. +5 is held constant at 1.0 A. Cross regulation is specified for two conditions:

Negative aux.= 3.76 W; positive aux.= 0.37 W to 3.76 W.

Negative aux. = 0.37 W to 3.76 W; positive aux. = 3.76 W.

7. Load fault = <0.05 Ω.

8. Transition time is 2 – 10 μs.

9. Time to settle to within 1% of Vout final value.

# MHF+ Single, Dual and Triple DC/DC Converters

## 28 VOLT INPUT – 15 WATT

Typical Performance Curves: 25°C Tc , 28 VDC Vin, 100% load, free run, unless otherwise specified.

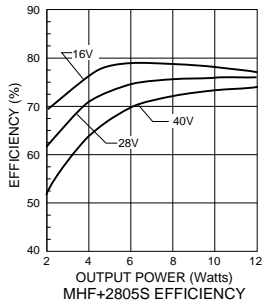

FIGURE 8

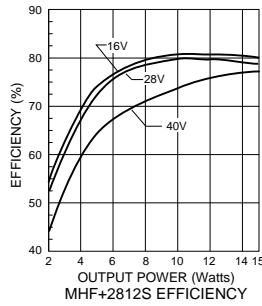

FIGURE 9

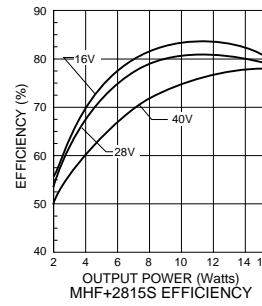

FIGURE 10

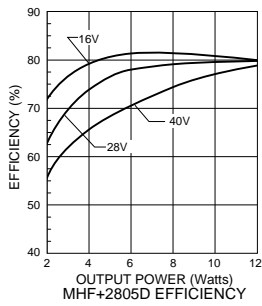

FIGURE 11

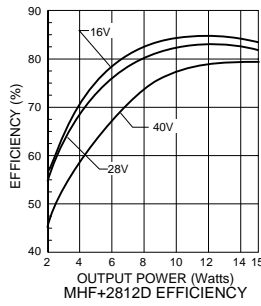

FIGURE 12

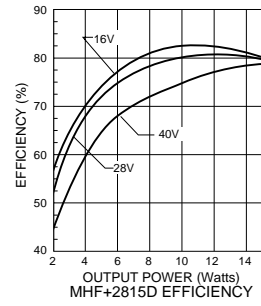

FIGURE 13

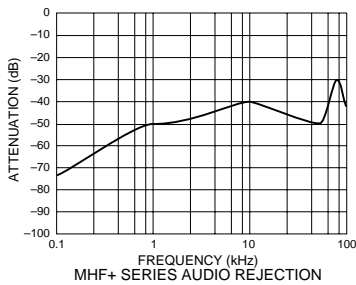

FIGURE 14

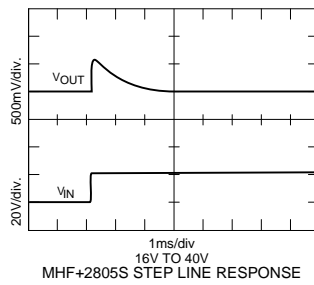

FIGURE 14

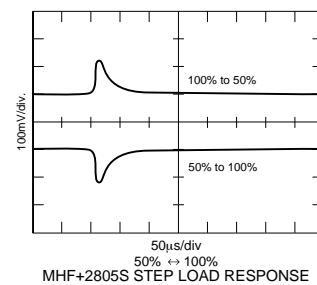

FIGURE 15

# MHF+ Single, Dual and Triple DC/DC Converters

## 28 VOLT INPUT – 15 WATT

Typical Performance Curves: 25°C Tc , 28 VDC Vin, 100% load, free run, unless otherwise specified.

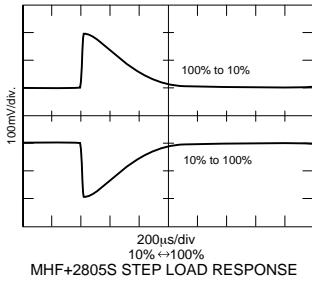

FIGURE 16

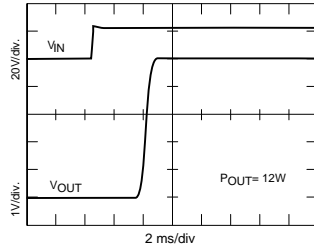

FIGURE 17

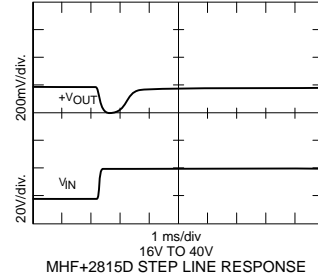

FIGURE 18

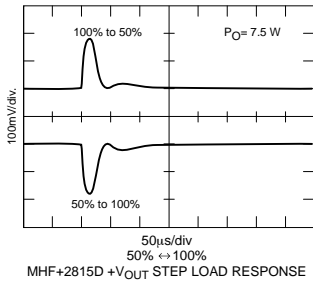

FIGURE 19

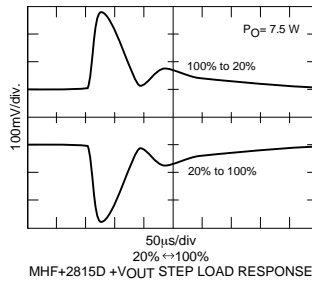

FIGURE 20

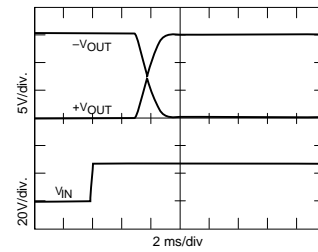

FIGURE 21

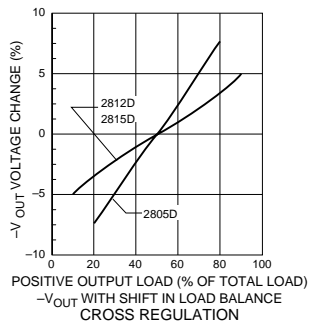

FIGURE 22

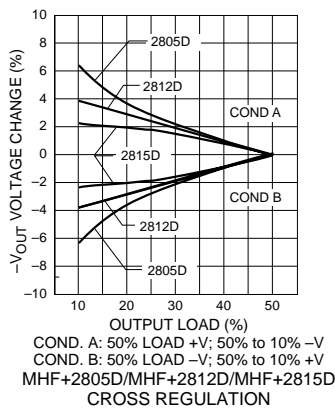

FIGURE 23

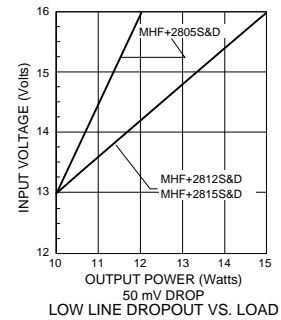

FIGURE 24

# MHF+ Single, Dual and Triple DC/DC Converters

## 28 VOLT INPUT – 15 WATT

Typical Performance Curves: 25°C Tc , 28 VDC Vin, 100% load, free run, unless otherwise specified.

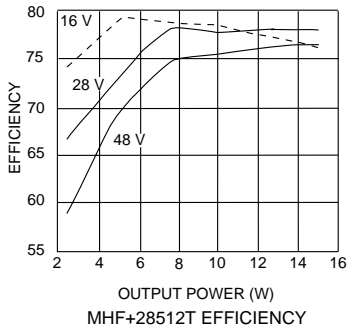

FIGURE 25

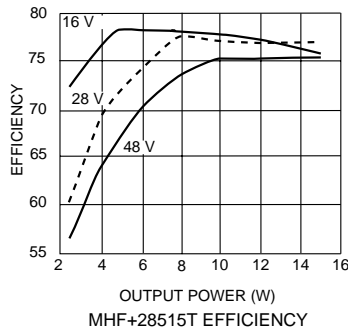

FIGURE 26

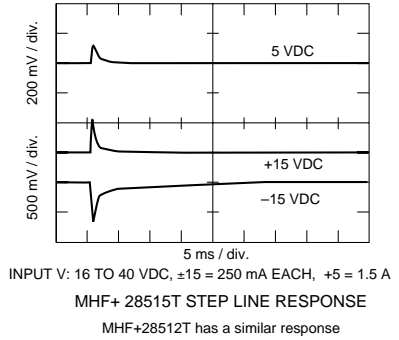

FIGURE 27

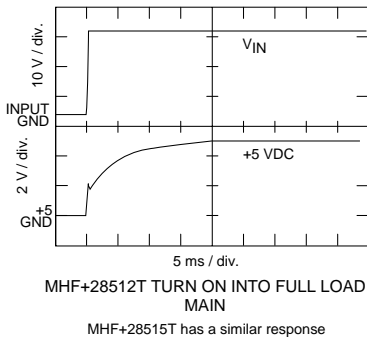

FIGURE 28

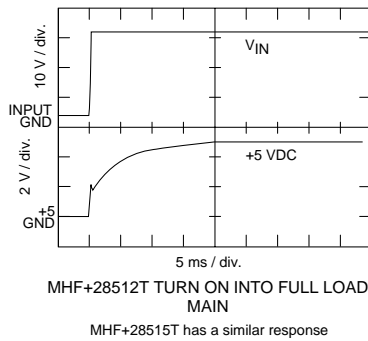

FIGURE 29

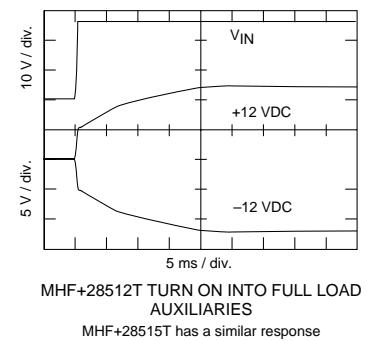

FIGURE 30

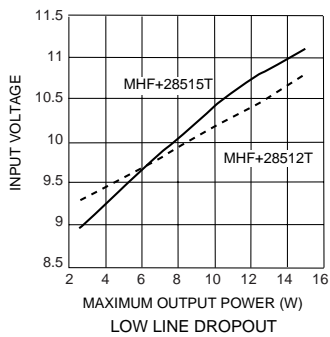
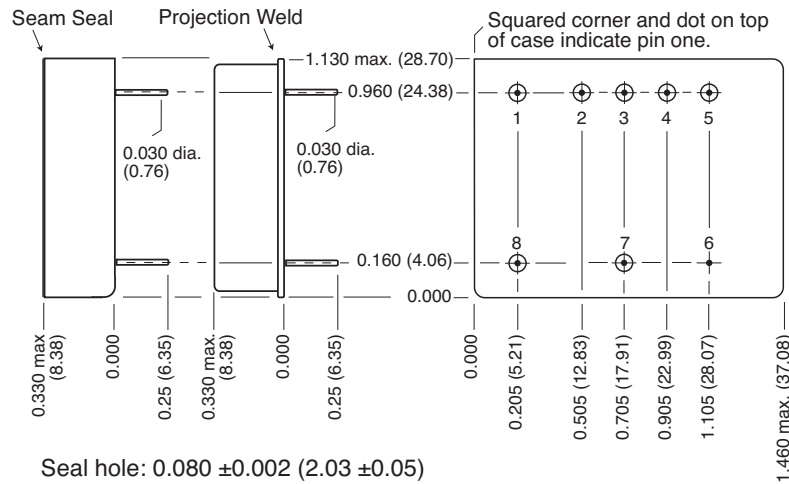

FIGURE 31

# MHF+ Single, Dual and Triple DC/DC Converter Cases

## 28 VOLT INPUT – 15 WATT

### BOTTOM VIEW CASE E1



Seal hole:  $0.080 \pm 0.002$  (2.03  $\pm 0.05$ )

#### Case dimensions in inches (mm)

Tolerance  $\pm 0.005$  (0.13) for three decimal places  
 $\pm 0.01$  (0.3) for two decimal places  
 unless otherwise specified

#### CAUTION

Heat from reflow or wave soldering may damage the device.  
 Solder pins individually with heat application not exceeding 300°C for 10 seconds per pin.

#### Materials

Header      Cold Rolled Steel/Nickel/Gold  
 Cover      Kovar/Nickel  
 Pins      #52 alloy/Gold compression glass seal

Case E1, Rev C, 20060111

Please refer to the numerical dimensions for accuracy. All information is believed to be accurate, but no responsibility is assumed for errors or omissions. Interpoint reserves the right to make changes in products or specifications without notice.

Copyright © 1999-2006 Interpoint Corp. All rights reserved.

**FIGURE 32: CASE E1 – SINGLE AND DUAL MODELS**

# MHF+ Single, Dual and Triple DC/DC Converter Cases

## 28 VOLT INPUT – 15 WATT

BOTTOM VIEW CASE E2

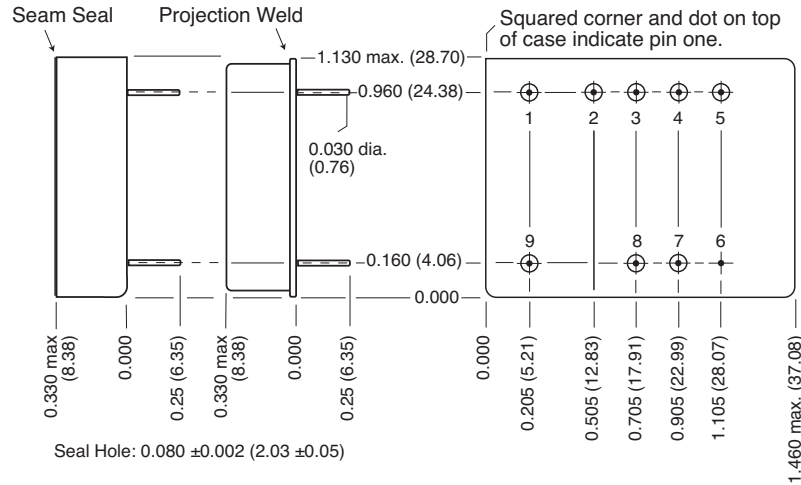

Seal Hole: 0.080 ±0.002 (2.03 ±0.05)

**Case dimensions in inches (mm)**

Tolerance ±0.005 (0.13) for three decimal places  
 ±0.01 (0.3) for two decimal places  
 unless otherwise specified

**CAUTION**

Heat from reflow or wave soldering may damage the device.  
 Solder pins individually with heat application not exceeding 300°C for 10 seconds per pin

**Materials**

Header Cold Rolled Steel/Nickel/Gold  
 Cover Kovar/Nickel  
 Pins #52 alloy/Gold compression glass seal

Case E2, Rev C, 20060111  
 Please refer to the numerical dimensions for accuracy. All information is believed to be accurate, but no responsibility is assumed for errors or omissions. Interpoint reserves the right to make changes in products or specifications without notice.  
 Copyright © 1999-2006 Interpoint Corp. All rights reserved.

**FIGURE 33: CASE E2 – TRIPLE MODELS**



# MHF+ Single, Dual and Triple DC/DC Converter Cases

## 28 VOLT INPUT – 15 WATT

### BOTTOM VIEW CASE G1

Flanged cases: Designator "F" required in Case Option position of model number

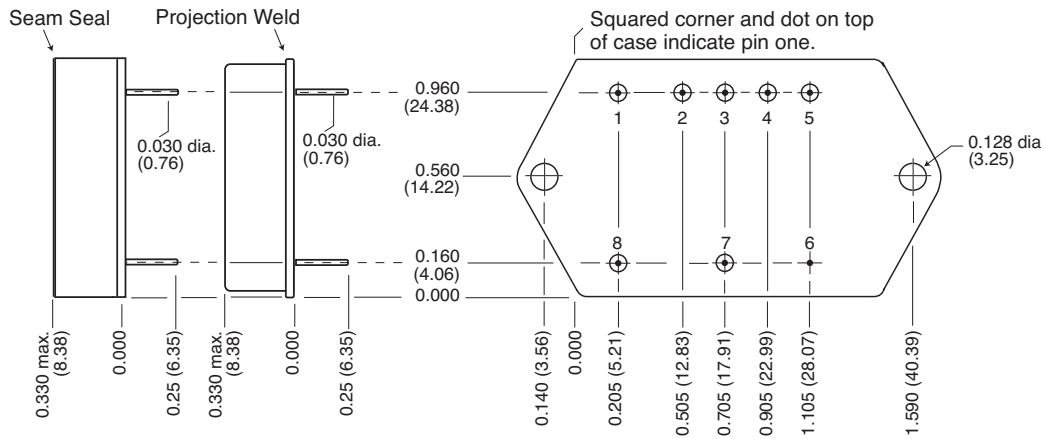

Seal hole: 0.080 ±0.002 (2.03 ±0.05)

#### Case dimensions in inches (mm)

Tolerance ±0.005 (0.13) for three decimal places  
 ±0.01 (0.3) for two decimal places  
 unless otherwise specified

#### CAUTION

Heat from reflow or wave soldering may damage the device.  
 Solder pins individually with heat application not exceeding 300°C for 10 seconds per pin.

Case G1, Rev B, September 23, 2005  
 Please refer to the numerical dimensions for accuracy. All information is believed to be accurate, but no responsibility is assumed for errors or omissions. Interpoint reserves the right to make changes in products or specifications without notice.  
 Copyright © 1999-2005 Interpoint Corp. All rights reserved.

**FIGURE 34: CASE G1 — SINGLE AND DUAL MODELS**

# MHF+ Single, Dual and Triple DC/DC Converter Cases

## 28 VOLT INPUT – 15 WATT

### BOTTOM VIEW CASE G2

Flanged cases: Designator "F" required in Case Option position of model number

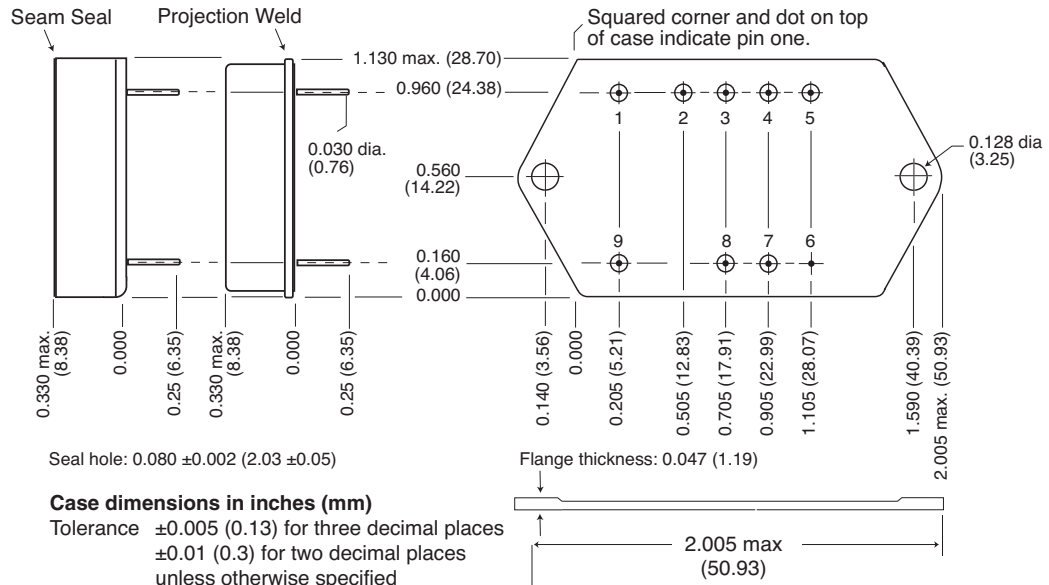

**CAUTION**

Heat from reflow or wave soldering may damage the device.  
Solder pins individually with heat application not exceeding 300°C for 10 seconds per pin.

**Materials**

- Header      Cold Rolled Steel/Nickel/Gold
- Cover      Kovar/Nickel
- Pins      #52 alloy/Gold compression glass seal

Case G2, Rev C, 20060111  
Please refer to the numerical dimensions for accuracy. All information is believed to be accurate, but no responsibility is assumed for errors or omissions. Interpoint reserves the right to make changes in products or specifications without notice.  
Copyright © 1999-2006 Interpoint Corp. All rights reserved.

**FIGURE 34: CASE G2 — TRIPLE MODELS**

## MHF+ Single, Dual and Triple DC/DC Converters

28 VOLT INPUT – 15 WATT

### 883, CLASS H, QML PRODUCTS – ELEMENT EVALUATION

ELEMENT EVALUATION  TEST PERFORMED (COMPONENT LEVEL)	STANDARD (NON-QML) <sup>1</sup>		CLASS H, QML	
	M/S <sup>2</sup>	P <sup>3</sup>	M/S <sup>2</sup>	P <sup>3</sup>
Element Electrical (probe)	yes	no	yes	yes
Element Visual	no	no	yes	yes
Internal Visual	no	no	yes	no
Final Electrical	no	no	yes	yes
Wire Bond Evaluation <sup>4</sup>	no	no	yes	yes
SLAM™/C-SAM: Input Capacitors only (Add'l test, not req. by H or K)	no	no	no	yes

**Definitions:**

Element Evaluation: Component testing/screening per MIL-STD-883 as determined by MIL-PRF-38534

SLAM™: Scanning Laser Acoustic Microscopy

C-SAM: C - Mode Scanning Acoustic Microscopy

**Notes:**

1. Non-QML products do not meet all of the requirements of MIL-PRF-38534
2. M/S = Active components (Microcircuit and Semiconductor Die)
3. P = Passive components
4. Not applicable to EMI filters that have no wire bonds

## MHF+ Single, Dual and Triple DC/DC Converters

28 VOLT INPUT – 15 WATT

# 883, CLASS H, QML PRODUCTS – ENVIRONMENTAL SCREENING

TEST	125°C STANDARD non-QML	125°C /ES non-QML	Class H /883 QML
Pre-cap Inspection Method 2017, 2032	yes	yes	yes
Temperature Cycle (10 times) Method 1010, Cond. C, -65°C to 150°C, ambient Method 1010, Cond. B, -55°C to 125°C, ambient	no no	no yes	yes no
Constant Acceleration Method 2001, 3000 g Method 2001, 500g	no no	no yes	yes no
Burn-In Method 1015, 160 hours at 125°C case, typical 96 hours at 125°C case, typical	no no	no yes	yes no
Final Electrical Test MIL-PRF-38534, Group A Subgroups 1 through 6: -55°C, +25°C, +125°C case Subgroups 1 and 4: +25°C case	no yes	no yes	yes no
Hermeticity Test Fine Leak, Method 1014, Cond. A Gross Leak, Method 1014, Cond. C Gross Leak, Dip (1 x 10 <sup>-3</sup> )	no no yes	yes yes no	yes yes no
Final Visual Inspection Method 2009	yes	yes	yes

Test methods are referenced to MIL-STD-883 as determined by MIL-PRF-38534.