



Specification FR2001H-T

SSC		CUSTOMER
Drawn	Approval	Approval

CONTENTS

1. Absolute Maximum Ratings
2. Electro Characteristics
3. Outline Dimension
4. Electro-Optical characteristic Diagram
5. Packing
6. Soldering
7. Precaution for use

FR2001H-T

Description

- Small size suitable for compact appliances.
- Surface-mounted chip LED device.
- Pb-free and RoHS complaint component.
- Tape and Reel packing.
- Increases the life time of battery.

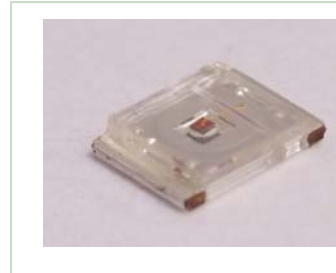

FR2001H-T

Features

- 3.5 (W) X 2.8 (D) X 0.6 (T) mm
- Chip LED of Reflector type
- Viewing Angle: 140 °
- Dominant Wavelength : 625 nm

Applications

- Electric appliance
- Other decoration lighting

1. Absolute maximum ratings

(Ta=25°C)

Parameter	Symbol	Value	Unit
Power Dissipation	P_d	80	mW
Forward Current	I_F	30	mA
Peak Forward Current	I_{FM}^{*1}	50	mA
Reverse Voltage	V_R	5	V
Operation Temperature	$T_{opr.}$	-40 ~ 100	°C
Storage Temperature	$T_{stg.}$	-40 ~ 100	°C

*1 I_{FM} conditions: Pulse width $T_w \leq 0.1ms$ and Duty ratio $\leq 1/10$.

2. Electro-Optical Characteristics

(Ta=25°C)

Parameter	Symbol	Condition	Min	Typ	Max	Unit
Forward Voltage	V_F	$I_F=20\text{ mA}$	-	2.0	2.6	V
Reverse Current	I_R	$V_R=5V$	-	-	10	μA
Luminous Intensity*2	I_V	$I_F=20\text{ mA}$	-	460	-	mcd
Luminous Flux	Φ	$I_F=20\text{ mA}$	-	1.45	-	lm
Wavelength	λ_d	$I_F=20\text{ mA}$	-	625	-	nm
Spectral Bandwidth	$\Delta\lambda$	$I_F=20\text{ mA}$	-	15	-	nm
Viewing Angle*3	$2\theta_{1/2}$	$I_F=20\text{ mA}$	-	140	-	°

*2 The luminous intensity I_V is measured at the peak of the spatial pattern which may not be aligned with the mechanical axis of the LED package.

*3 $\theta_{1/2}$ is the off-axis where the luminous intensity is 1/2 the peak intensity.

[Note] All products confirm to the listed minimum and maximum specifications for electric and optical characteristics, when operated at 20mA within the maximum ratings shown above. All measurements were made under the standardized environment of SSC.

(Tolerance : $I_v \pm 10\%$, $\lambda_D \pm 2\text{ nm}$, $V_F \pm 0.1\text{ V}$)

3.Outline Dimension

(Tolerance: ± 0.1 , Unit: mm)

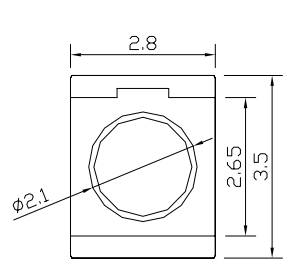

[TOP VIEW]

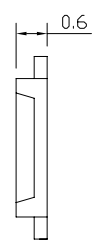

[SIDE VIEW]

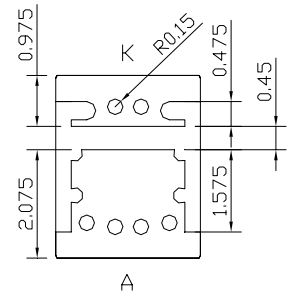

[BOTTOM VIEW]

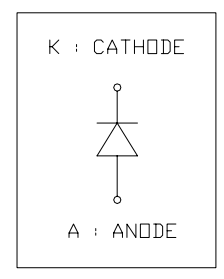

[INNER CIRCUIT]

- Recommended Soldering Design

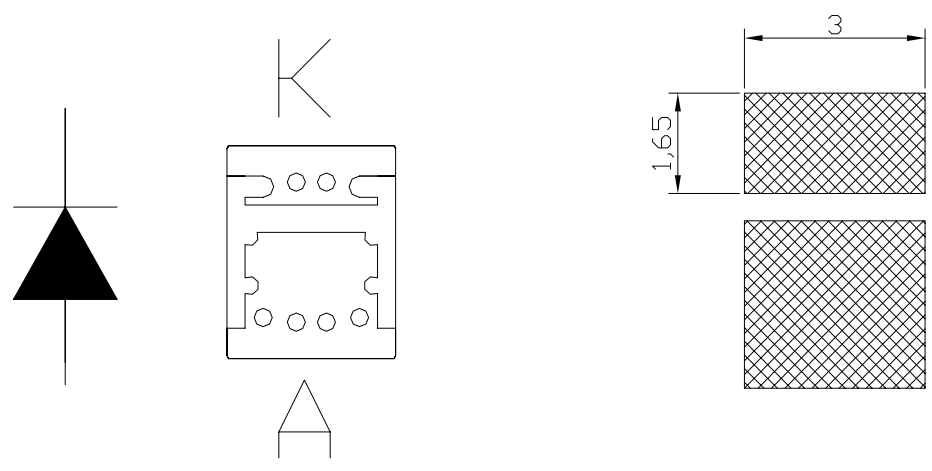

* MATERIALS

PARTS	MATERIALS
Package	Lead Frame
Encapsulating Resin	Epoxy Resin
Electrodes	Au Plating Copper Alloy

4. Electro-Optical characteristic Diagram

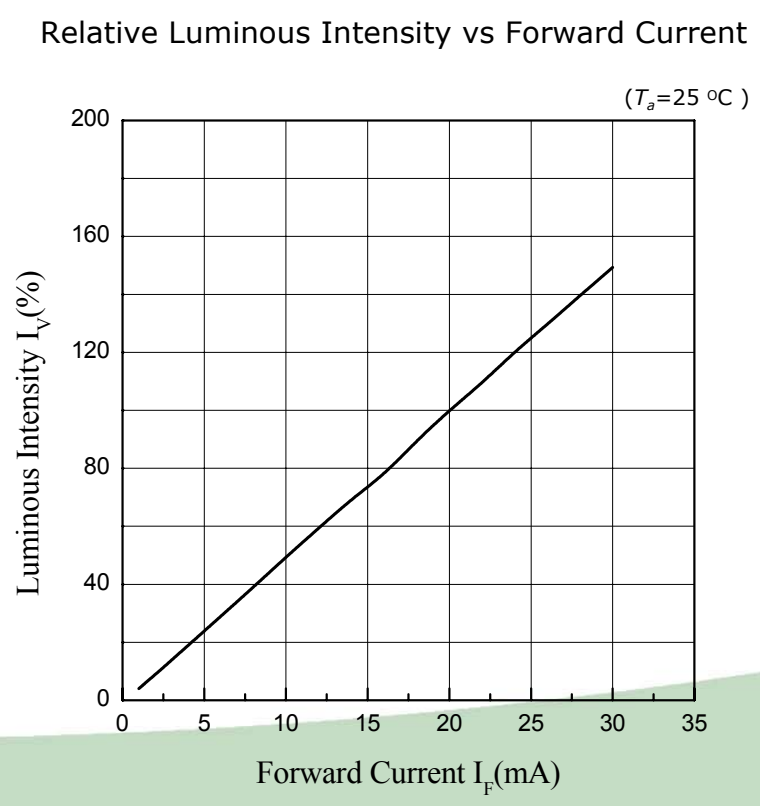
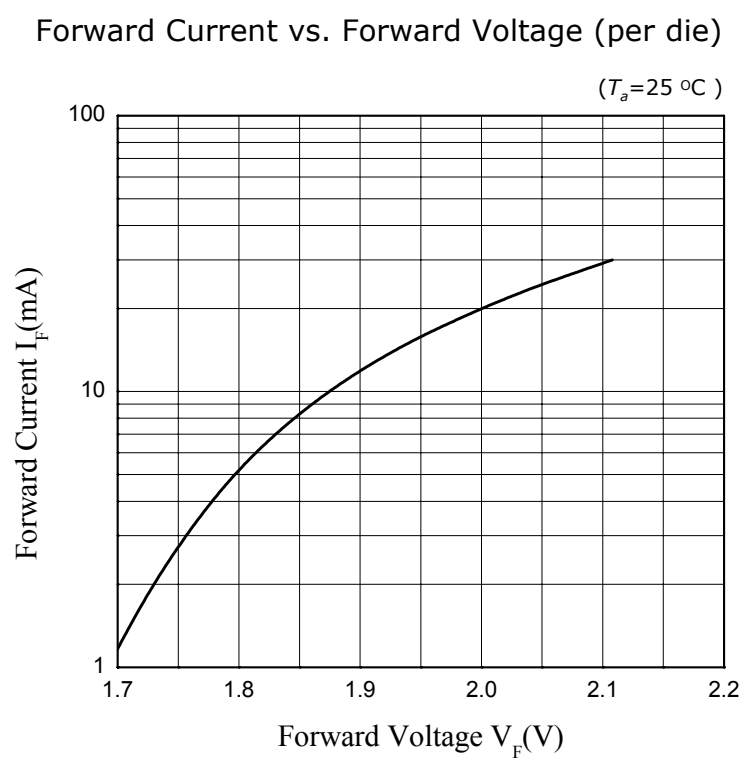

Ambient Temperature vs. Allowable Forward Current (per die)

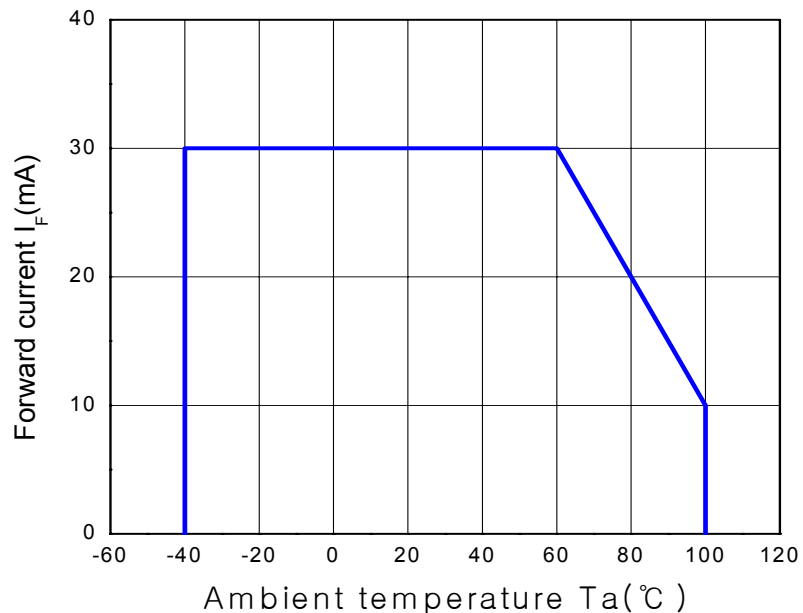

Radiation Diagram

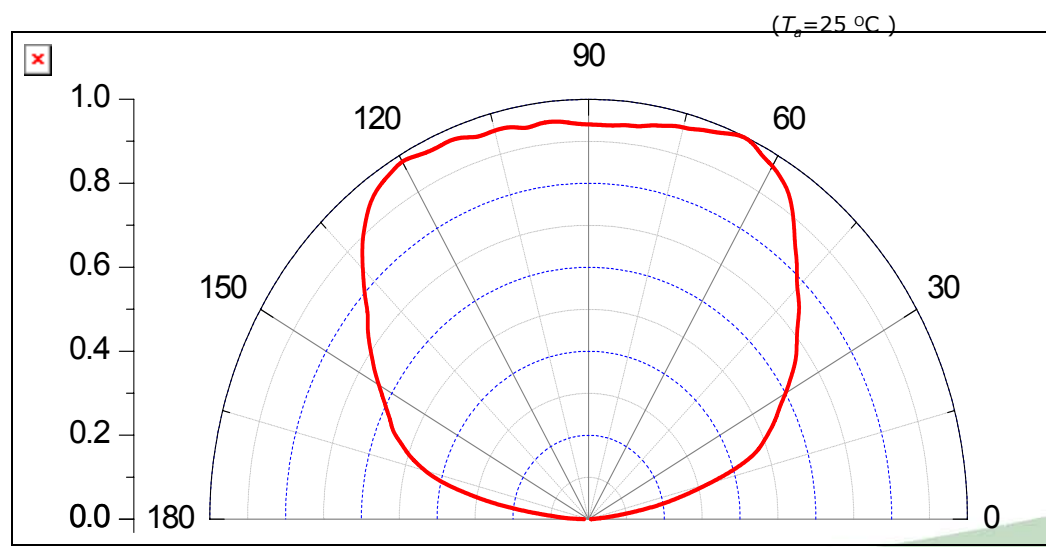

5. Packing

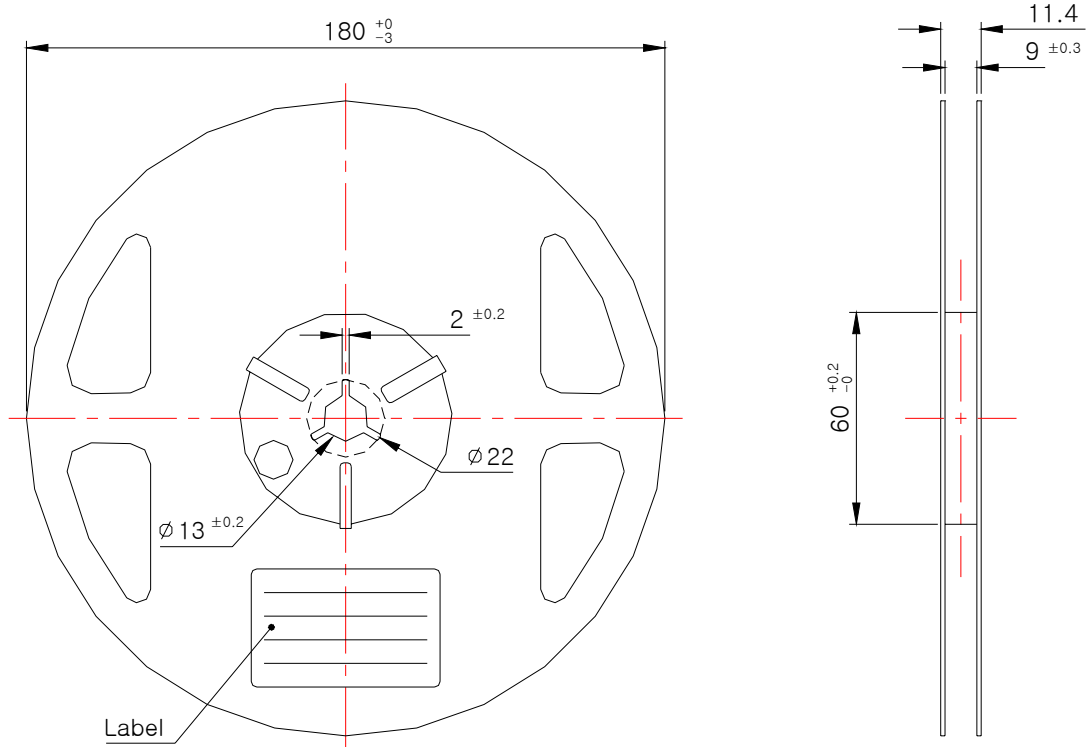
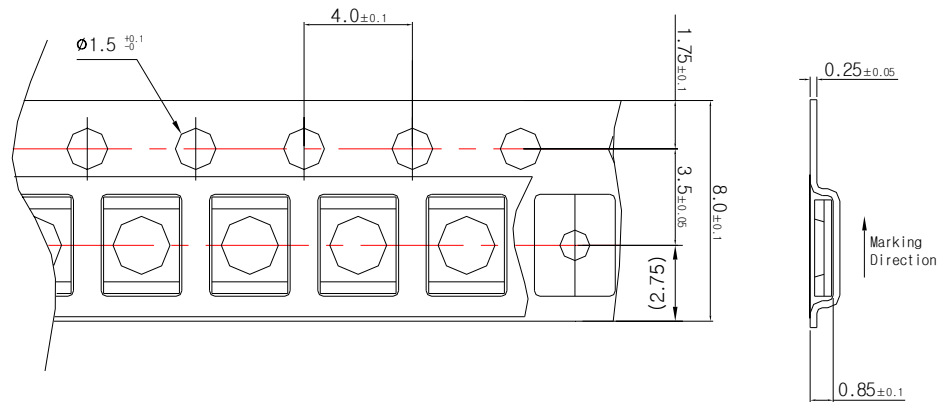

- (1) Quantity: 2,000 pcs./Reel
- (2) Cumulative Tolerance: Cumulative Tolerance/10 pitches to be ± 0.2 mm
- (3) Adhesion Strength of Cover Tape: Adhesion strength to be 0.1-0.7 N when the over tape is turned off from the carrier tape at 10° angle to be the carrier tape.
- (4) Package: P/N, Manufacturing data Code No. and quantity to be indicated on a damp proof Package.

● Reel Packing Structure

Reel

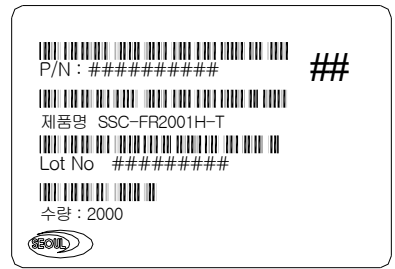
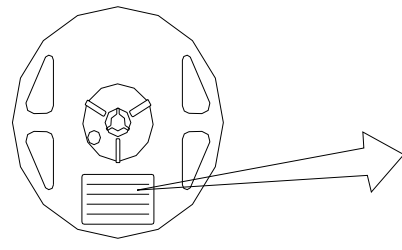

Aluminum Vinyl Bag

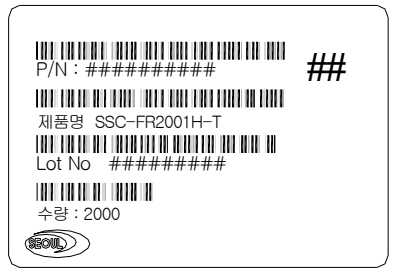
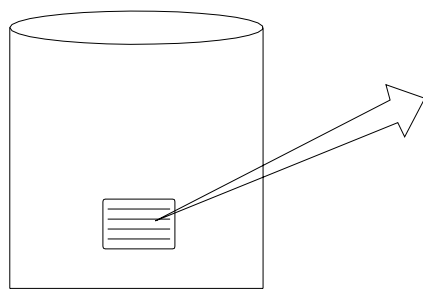

Outer Box

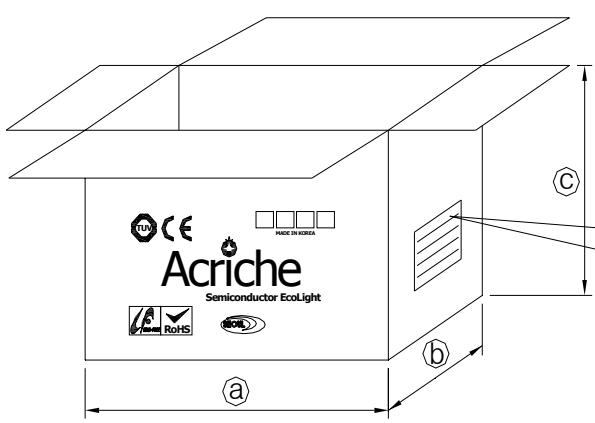

*Material: Paper (SW3B(B))

TYPE	SIZE (mm)		
	(a)	(b)	(c)
7 inch	245	220	142

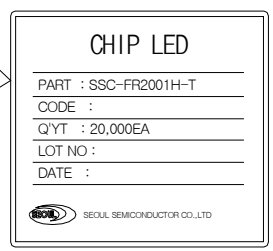

6. Soldering

(1) Lead Solder

Lead Solder	
Pre-heat	120~150℃
Pre-heat time	120 sec. Max.
Peak-Temperature	240℃ Max.
Soldering time Condition	10 sec. Max.

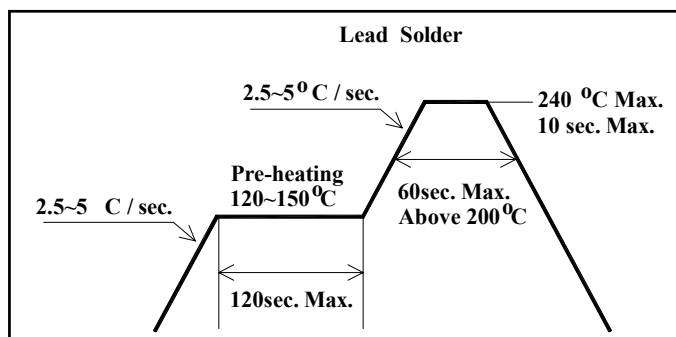

(2) Lead-Free Solder

Lead Free Solder	
Pre-heat	150~200℃
Pre-heat time	120 sec. Max.
Peak-Temperature	260℃ Max.
Soldering time Condition	10 sec. Max.

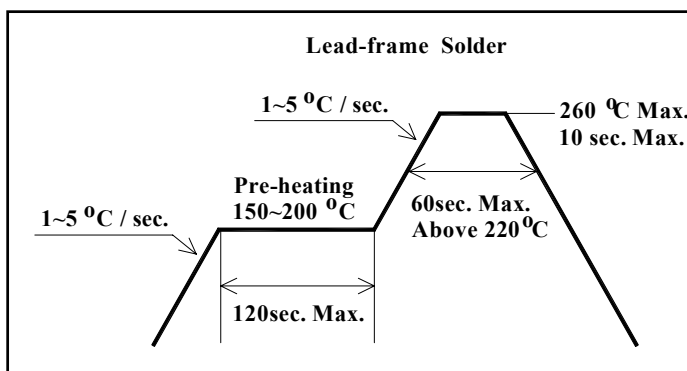

(3) Hand Soldering conditions

Do not exceed 3 seconds at maximum 280°C under soldering iron.

(4) The encapsulated material of the LEDs is silicone.

Precautions should be taken to avoid the strong pressure on the encapsulated part.

So when using the chip mounter, the picking up nozzle that does not affect the silicone resin should be used.

Note : In case that the soldered products are reused in soldering process, we don't guarantee the products.

7. Precaution for use

(1) Storage

In order to avoid the absorption of moisture, it is recommended to store in a dry box (or a desiccator) with a desiccant. Otherwise, to store them in the following environment is recommended.

Temperature : 5°C ~30°C Humidity : maximum 65%RH

(2) Attention after open.

LED is correspond to SMD, when LED be soldered dip, interfacial separation may affect the light transmission efficiency, causing the light intensity to drop. Attention in followed;

a. After opened and mounted the soldering shall be quickly.

b. Keeping of a fraction

Temperature : 5 ~ 40°C Humidity : less than 30%

(3) In the case of more than 1 week passed after opening or change color of indicator on desiccant, components shall be dried 10-12hr. at 60±5°C.

(4) Any mechanical force or any excess vibration shall not be accepted to apply during cooling process to normal temperature after soldering.

(5) Quick cooling shall be avoided.

(6) Components shall not be mounted on warped direction of PCB.

(7) Anti radioactive ray design is not considered for the products.

(8) This device should not be used in any type of fluid such as water, oil, organic solvent etc. When washing is required, IPA should be used.

(9) When the LEDs are illuminating, operating current should be decided after considering the ambient maximum temperature.

(10) LEDs must be stored to maintain a clean atmosphere. If the LEDs are stored for 3 months or more after being shipped from SSC, a sealed container with a nitrogen atmosphere should be used for storage.

(11) The LEDs must be soldered within seven days after opening the moisture-proof packing.

(12) Repack unused products with anti-moisture packing, fold to close any opening and then store in a dry place.

(13) The appearance and specifications of the product may be modified for improvement without notice.