



Pb Free

Specification

SSC-FCW100

(Rev 1.7, General)

SSC		Customer
Drawn	Approval	Approval

[Contents]

1. **Absolute maximum ratings**
2. **Electro-optical characteristics**
3. **CIE Chromaticity Diagram**
4. **Characteristic diagram**
5. **Soldering profile**
6. **Outline dimension**
7. **Recommended soldering pad design**
8. **Reel packing dimension**
9. **Packing**
10. **Precaution for use**

SSC-FCW100

Description

- White colored SMT package
- Suitable for all SMT assembly methods and all soldering methods

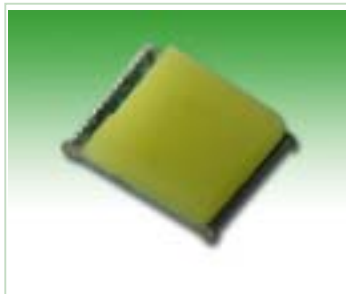

SSC-FCW100

Features

- 2.0 X 1.5 X 0.5 mm
- x, y coordination
x: 0.31, Y 0.31

Applications

- Cellular phone's Flash lighting
- Other decoration lighting

SSC-FCW100

Revision 1.7

www.ZLED.com

: SSC-QP-7-07-24 (Rev.0.0)

1. Absolute maximum ratings ^{*1}

(Ta=25)

Parameter	Symbol	Value	Unit
Power Dissipation	P_d	560	mW
Forward Current	I_F	175	mA
Peak Forward Current	I_{FM}^{*2}	600	mA
Reverse Voltage	V_R	5	V
LED Junction Temperature	T_j	125	
Operation Temperature	$T_{opr.}$	-30 ~ 85	
Storage Temperature	$T_{stg.}$	-40 ~ 100	

*1 Care is to be taken that power dissipation does not exceed the absolute maximum rating of the product.

*2 I_{FM} conditions is pulse width $T_w = 300ms$ and Duty ratio $1/10$

2. Electro-Optical Characteristics

(Ta=25)

Parameter	Symbol	Condition	Min	Typ	Max	Unit
Forward Voltage	V_F	$I_F=175\text{ mA}$	2.7	3.0	3.7	V
		$I_F=320\text{ mA}$ (Flash mode ^{*2})		3.2	-	
Reverse Current	I_R	$V_R=5V$	-	-	30	μA
Luminous Intensity ^{*1}	I_v	$I_F=175\text{ mA}$	2.5	5.5	8	cd
		$I_F=320\text{ mA}$ (Flash mode ^{*2})	-	9	-	
Luminous Flux ^{*3}	Φ_v	$I_F=175\text{ mA}$	-	17	25	Lm
Illumination ^{*4}	I_x	$I_F=175\text{ mA}$	-	5.5	8	lx@1m
		$I_F=320\text{ mA}$ (Flash mode ^{*2})	-	9	-	
Chromaticity Coordination	X	$I_F=175\text{ mA}$	-	0.31	-	-
	Y		-	0.31	-	
Viewing Angle ^{*5}	$2_{1/2}$	$I_F=20\text{ mA}$		130		°

*1. The luminous intensity I_v is measured at the peak of the spatial pattern which may not be aligned with the mechanical axis of the LED package.

*2. Flash mode conditions are pulse width $T_w = 1sec$, duty ratio = 2/7

*3. Luminous flux measurement allowance is $\pm 10\%$

*4. This luminous intensity (Lux) is measured at a distance of 1m with condition $T_a = 25$ and it has 10% tolerance.

*5. $_{1/2}$ is the off-axis where the luminous intensity is $\frac{1}{2}$ of the peak intensity.

[Note] All measurements were made under the standardized environment of SSC
(Tolerance : Color Coordinate ± 0.005 , $V_F = \pm 0.1$)

SSC-FCW100

Revision 1.7

www.ZLED.com

: SSC - QP - 7 - 07 - 24 (Rev.0.0)

3. CIE chromaticity Diagram

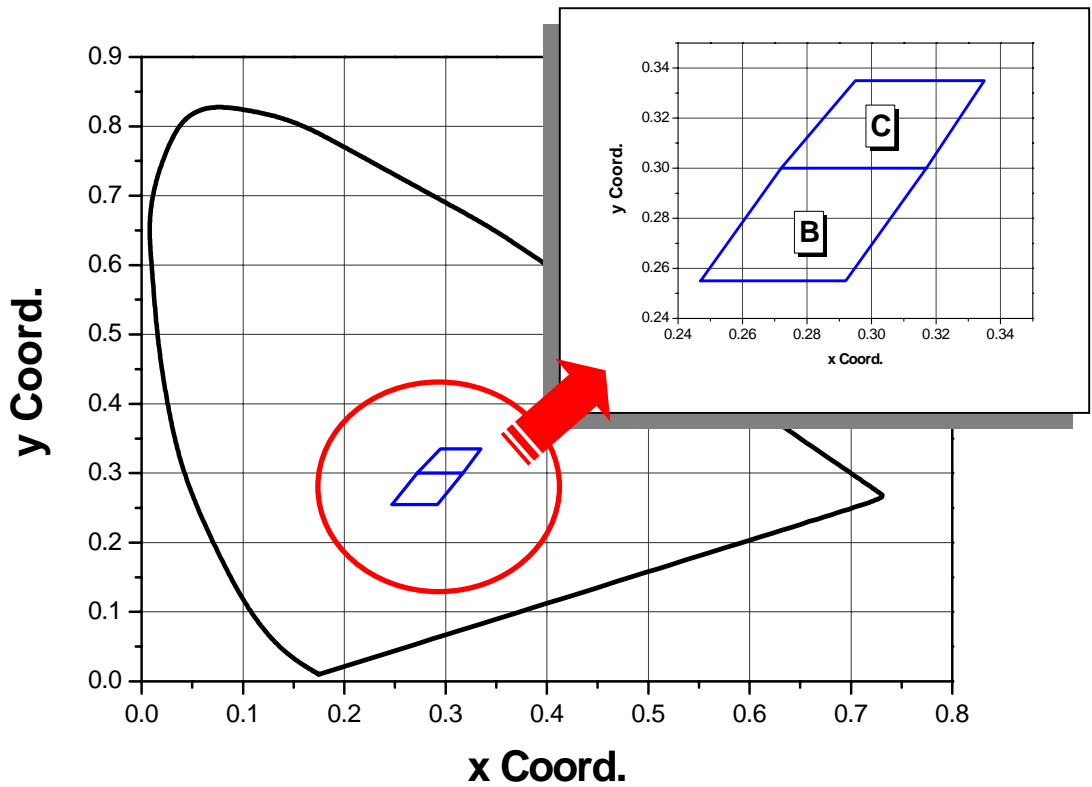

Color Rank

Rank	Chromaticity Coordination				
B	x	0.247	0.292	0.272	0.317
	y	0.255	0.255	0.300	0.300
C	x	0.272	0.317	0.295	0.335
	y	0.300	0.300	0.335	0.335

4. Characteristic Diagram

Forward Current vs Forward Voltage

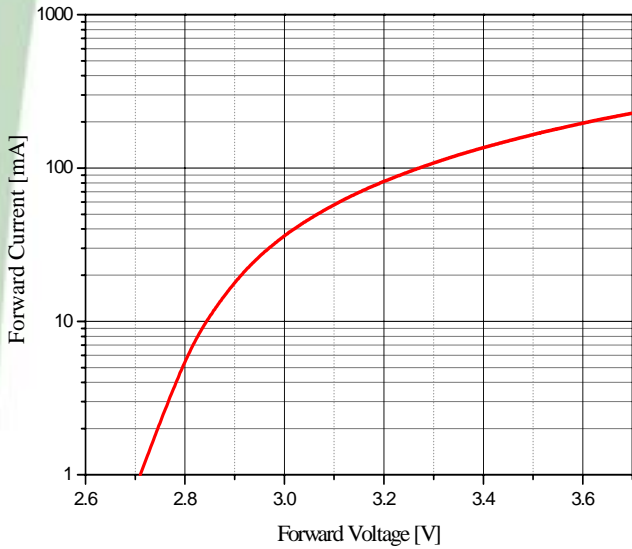

Relative Intensity vs Forward Current

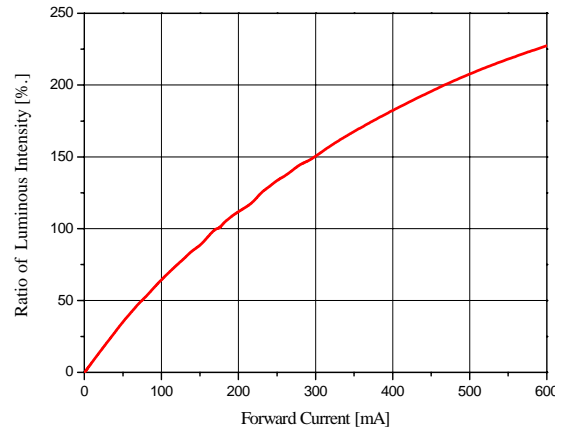

Forward Current vs Derating Curve

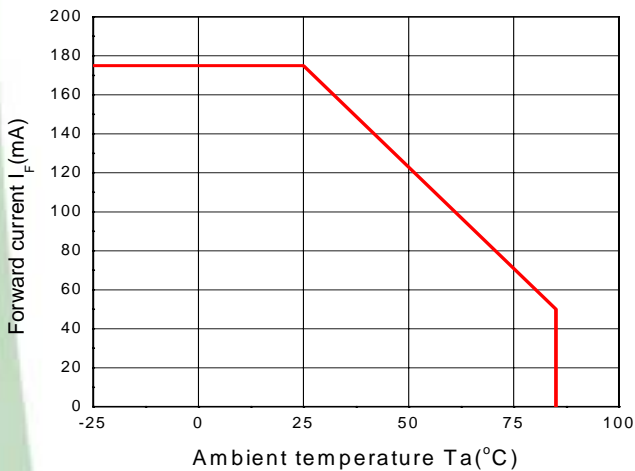

Forward Current vs Chromaticity Coordinate

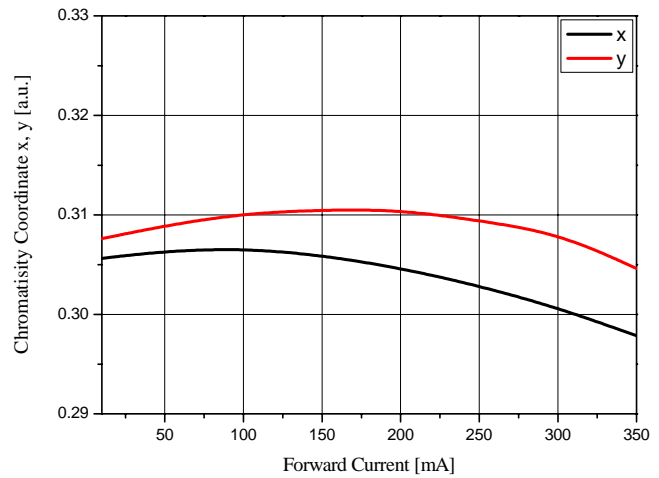

Radiation Diagram

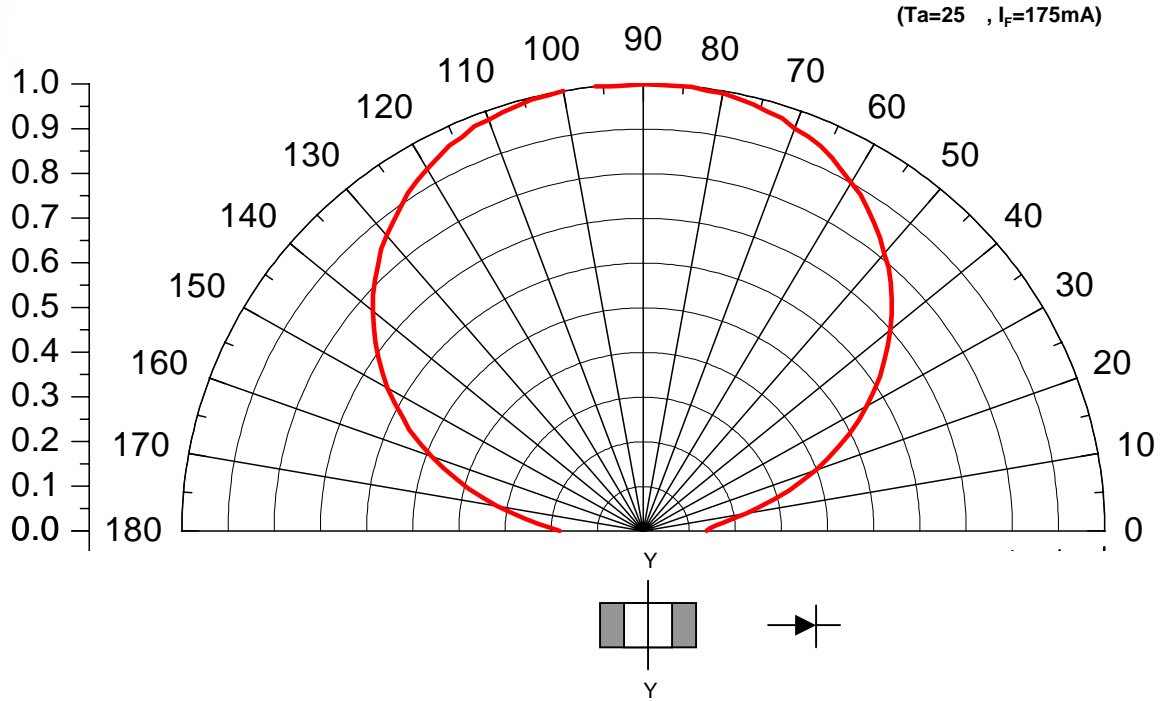

Spectrum

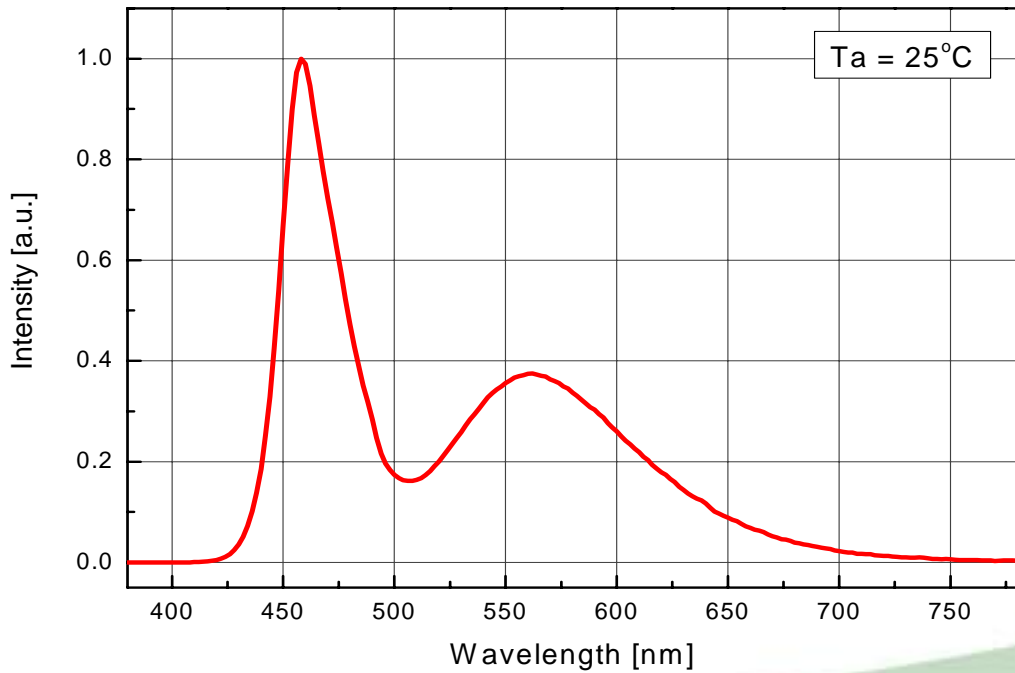

5. Soldering profile

Reflow Soldering Conditions/ Profile

(1) Lead Solder

- Preliminary heating to be at 210 max. for 2 minutes max.
- Soldering heat to be at 240 max. for 10 seconds max.

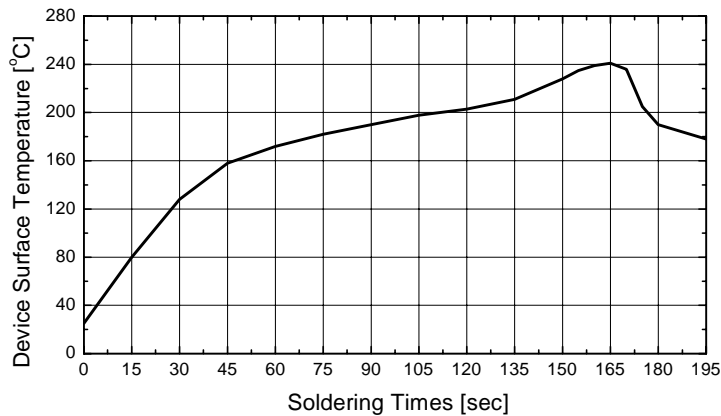

(2) Lead-Free Solder

- Preliminary heating to be at 220 max. for 2 minutes max.
- Soldering heat to be at 260 max. for 10 seconds max.

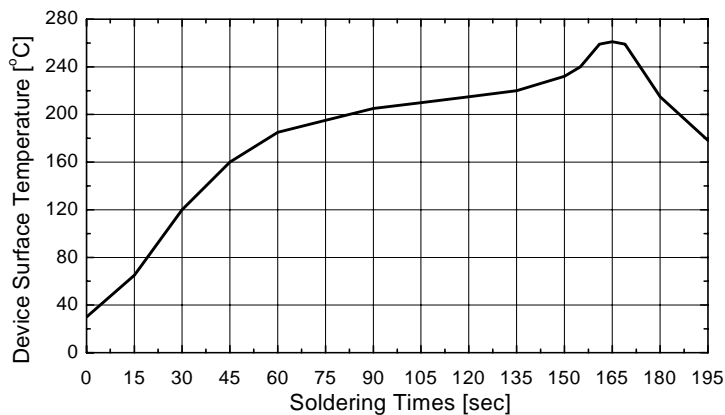

(3) Hand Soldering Condition

- Not more than 3 seconds @MAX280 , under Soldering iron.

[Note] In case the soldered products are reused in soldering process, we don't guarantee the products.

6. Outline Dimension

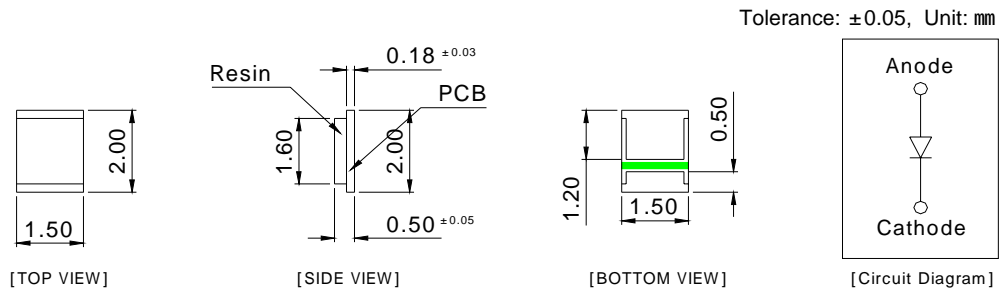

7. Recommended Soldering pad design

[Normal Solder pad]

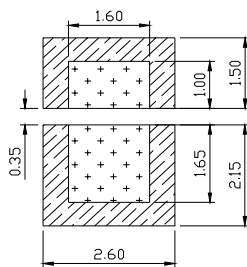

[Solder pad for heat radiation]

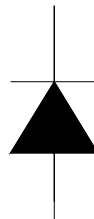
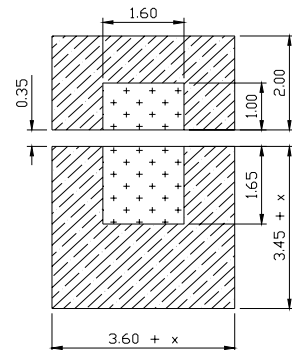

- Cu area with solder mask
(Pattern for heat radiation)
- soldering area

8. Reel Packing Dimension

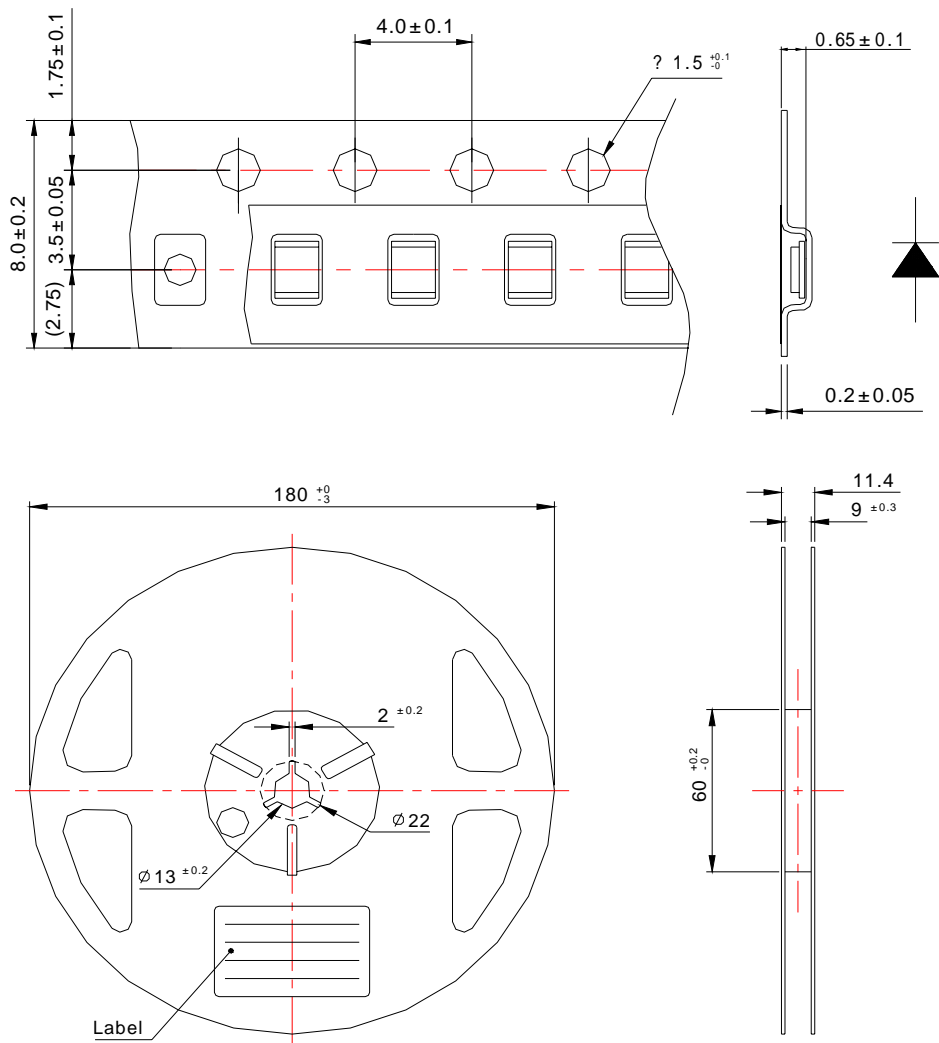

Tolerance: ± 0.2 , Unit: mm

- (1) Quantity: 2,000pcs./Reel
- (2) Cumulative Tolerance: Cumulative Tolerance/10pitches to be ± 0.2 mm
- (3) Adhesion Strength of Cover Tape: Adhesion strength to be 0.1-0.7N when the over tape is turned off from the carrier tape at 10° angle to be the carrier tape.
- (4) Package: P/N, Manufacturing data Code No. and quantity to be indicated on a damp proof Package.

SSC-FCW100

Revision 1.7

www.ZLED.com

: SSC-QP-7-07-24 (Rev.0.0)

9. Packing

Reel

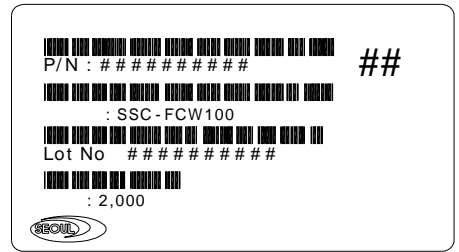
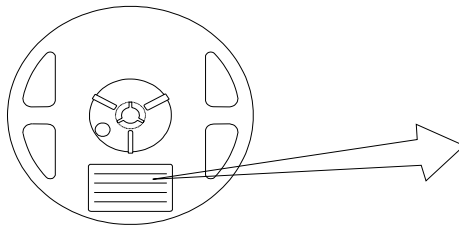

Aluminum Vinyl Bag

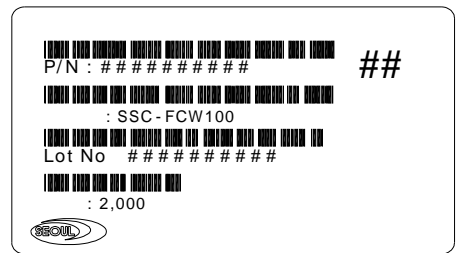
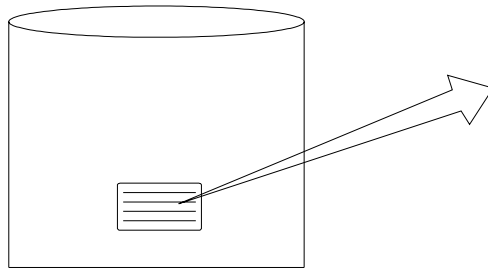

Outer Box

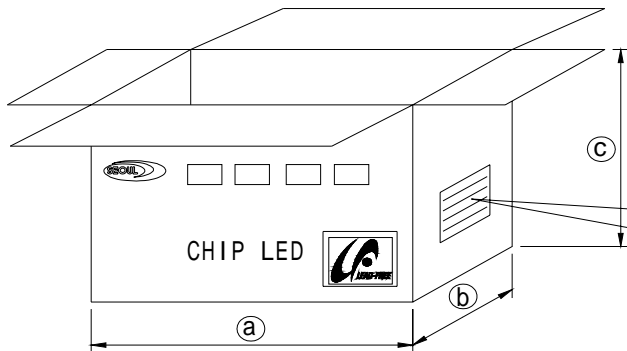

*Material: Paper(SW3B(B))

TYPE	SIZE(mm)		
	(a)	(b)	(c)
7inch	245	220	142

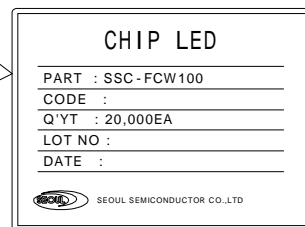

10. Precaution for Use

(1) Storage

In order to avoid the absorption of moisture, it is recommended to store in the dry box (or desiccator) with a desiccant. Otherwise, to store them in the following environment is recommended.

Temperature : 5 ~30 Humidity : 60%HR max.

(2) Attention after opened

However LED is corresponded SMD, when LED be soldered dip, interfacial separation may affect the light transmission efficiency, causing the light intensity to drop. Attention in followed.

a. After opened and mounted, the soldering shall be quickly.

b. Keeping of a fraction

Temperature : 5 ~ 40 Humidity : less than 30%

(3) In case of more than 1 week passed after opening or change color of indicator on desiccant components shall be dried 10-12hr. at 60 ± 5 .

(4) In case of supposed the components is humid, shall be dried dip-solder just before.

100Hr at 80 ± 5 or 12Hr at 100 ± 5 .

(5) Any mechanical force or any excess vibration shall not be accepted to apply during cooling process to normal temp. after soldering.

(6) Quick cooling shall not be avoid.

(7) Components shall not be mounted on warped direction of PCB.

(8) Anti radioactive ray design is not considered for the products listed here in.

(9) Gallium arsenide is used in some of the products listed in this publication. These products are dangerous if they are burned or smashed in the process of disposal. It is also dangerous to drink the liquid or inhale the gas generated by such products when chemically disposed.

(10) This device should not be used in any type of fluid such as water, oil, organic solvent and etc. When washing is required, IPA should be used.

(11) When the LEDs are illuminating, operating current should be decided after considering the ambient maximum temperature.

(12) LEDs must be stored to maintain a clean atmosphere. If the LEDs are stored for 3 months or more after being shipped from SSC, a sealed container with a nitrogen atmosphere should be used for storage.

(13) The LEDs must be soldered within seven days after opening the moisture-proof packing.

(14) Repack unused products with anti-moisture packing, fold to close any opening and then store in a dry place.

(15) The appearance and specifications of the product may be modified for improvement without notice.