

High Precision TCXO / VCTCXO

CONNOR WINFIELD



2111 Comprehensive Drive

Aurora, Illinois 60505

Phone: 630-851-4722

Fax: 630-851-5040

www.conwin.com

US Headquarters

630-851-4722:

European Headquarters:

+353-61-472221

Description

The Connor-Winfield 9.0x14.0mm Temperature Compensated Crystal Controlled Oscillators (TCXO series) and Voltage Controlled Temperature Compensated Crystal Controlled Oscillators (VCTCXO series) are designed for use in Telecom applications requiring tight frequency stability. Through the use of Analog Temperature Compensation, this device is capable of holding sub 1-ppm stabilities over the commercial or the industrial temperature ranges.



Features:

- TCXO or VCTCXO
- 3.3V or 5.0V Operation
- LVC MOS or HCMOS Output Logic
- 9x14mm Surface Mount Package
- Frequency Stabilities Available:
 - ±0.25ppm
 - ±0.28ppm
 - ±0.50ppm
 - ±1.00ppm
- Temperature Ranges Available:
 - 0 to 70°C
 - 40 to 85°C
- Low Jitter < 1pS RMS
- Tri-State Enable/Disable Function
- Tape and Reel Packaging
- RoHS Compliant / Lead Free

Applications

- STRATUM 3 Applications
- Timing Reference
- Instrumentation
- Femtocells
- FTTH, FTTC

Ordering Information

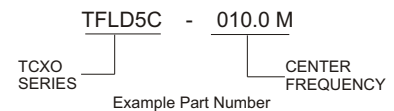

Standard Model Numbers

TABLE 1

Model Number	Frequency Range	Frequency Stability	Temperature Range	TCXO VCTCXO	Supply Voltage	Tables on Page 2
TFLD5C	6.4 to 32 MHz	±0.25 ppm	0 to 70°C	TCXO	3.3V	2
TFHD5C	6.4 to 32 MHz	±0.25 ppm	0 to 70°C	TCXO	5.0V	2
TVLD5C	6.4 to 32 MHz	±0.25 ppm	0 to 70°C	VCTCXO	3.3V	2
TVHD5C	6.4 to 32 MHz	±0.25 ppm	0 to 70°C	VCTCXO	5.0V	2
TFLD5D	6.4 to 40 MHz	±0.28 ppm	0 to 70°C	TCXO	3.3V	3
TFHD5D	6.4 to 40 MHz	±0.28 ppm	0 to 70°C	TCXO	5.0V	3
TFLD6D	6.4 to 40 MHz	±0.28 ppm	-40 to 85°C	TCXO	3.3V	3
TFHD6D	6.4 to 40 MHz	±0.28 ppm	-40 to 85°C	TCXO	5.0V	3
TVLD5D	6.4 to 40 MHz	±0.28 ppm	0 to 70°C	VCTCXO	3.3V	4
TVHD5D	6.4 to 40 MHz	±0.28 ppm	0 to 70°C	VCTCXO	5.0V	4
TVLD6D	6.4 to 40 MHz	±0.28 ppm	-40 to 85°C	VCTCXO	3.3V	4
TVHD6D	6.4 to 40 MHz	±0.28 ppm	-40 to 85°C	VCTCXO	5.0V	4
TFLD5E	6.4 to 52 MHz	±0.50 ppm	0 to 70°C	TCXO	3.3V	5
TFHD5E	6.4 to 52 MHz	±0.50 ppm	0 to 70°C	TCXO	5.0V	5
TFLD6E	6.4 to 52 MHz	±0.50 ppm	-40 to 85°C	TCXO	3.3V	5
TFHD6E	6.4 to 52 MHz	±0.50 ppm	-40 to 85°C	TCXO	5.0V	5
TVLD5E	6.4 to 52 MHz	±0.50 ppm	0 to 70°C	VCTCXO	3.3V	6
TVHD5E	6.4 to 52 MHz	±0.50 ppm	0 to 70°C	VCTCXO	5.0V	6
TVLD6E	6.4 to 52 MHz	±0.50 ppm	-40 to 85°C	VCTCXO	3.3V	6
TVHD6E	6.4 to 52 MHz	±0.50 ppm	-40 to 85°C	VCTCXO	5.0V	6
TFLD5F	6.4 to 52 MHz	±1.00 ppm	0 to 70°C	TCXO	3.3V	7
TFHD5F	6.4 to 52 MHz	±1.00 ppm	0 to 70°C	TCXO	5.0V	7
TFLD6F	6.4 to 52 MHz	±1.00 ppm	-40 to 85°C	TCXO	3.3V	7
TFHD6F	6.4 to 52 MHz	±1.00 ppm	-40 to 85°C	TCXO	5.0V	7
TVLD5F	6.4 to 52 MHz	±1.00 ppm	0 to 70°C	VCTCXO	3.3V	8
TVHD5F	6.4 to 52 MHz	±1.00 ppm	0 to 70°C	VCTCXO	5.0V	8
TVLD6F	6.4 to 52 MHz	±1.00 ppm	-40 to 85°C	VCTCXO	3.3V	8
TVHD6F	6.4 to 52 MHz	±1.00 ppm	-40 to 85°C	VCTCXO	5.0V	8



Bulletin Tx134

Page 1 of 4

Revision 05

Date 16 Apr 2007

Model Specifications

Model Number	TFLD5C	TFHD5C	TVLD5C	TVHD5C	TABLE 2 NOTE
Supply Voltage	3.3 Vdc	5.0 Vdc	3.3 Vdc	5.0 Vdc	
TCXO / VCTCXO	TCXO	TCXO	VCTCXO	VCTCXO	
Frequency Range	6.4 to 32 MHz				
Frequency Stability	±0.25ppm				1
Temperature Range	0 to 70°C				



Features

TCXO or VCTCXO
 3.3V or 5.0V Operation
 LVC MOS or HCMOS Output Logic
 Frequency Stabilities Available:
 ±0.25ppm
 ±0.28ppm
 ±0.50ppm
 ±1.00ppm
 Temperature Ranges Available:
 0 to 70°C
 -40 to 85°C
 Low Jitter < 1ps RMS
 Tri-State Enable/Disable
 Surface Mount Package
 Tape and Reel Packaging
 RoHS Compliant / Lead Free

Model Number	TFLD5D	TFHD5D	TVLD5D	TVHD5D	TABLE 3 NOTE
Supply Voltage	3.3 Vdc	5.0 Vdc	3.3 Vdc	5.0 Vdc	
TCXO / VCTCXO	TCXO	TCXO	VCTCXO	VCTCXO	
Frequency Range	6.4 to 40 MHz				
Frequency Stability	±0.28ppm				1
Temperature Range	0 to 70°C				
Holdover Stability	±0.32ppm				2

Model Number	TFLD6D	TFHD6D	TVLD6D	TVHD6D	TABLE 4 NOTE
Supply Voltage	3.3 Vdc	5.0 Vdc	3.3 Vdc	5.0 Vdc	
TCXO / VCTCXO	TCXO	TCXO	VCTCXO	VCTCXO	
Frequency Range	6.4 to 40 MHz				
Frequency Stability	±0.28ppm				1
Temperature Range	-40 to 85°C				
Holdover Stability	±0.32ppm				2

Model Number	TFLD5E	TFHD5E	TVLD5E	TVHD5E	TABLE 5 NOTE
Supply Voltage	3.3 Vdc	5.0 Vdc	3.3 Vdc	5.0 Vdc	
TCXO / VCTCXO	TCXO	TCXO	VCTCXO	VCTCXO	
Frequency Range	6.4 to 52 MHz				
Frequency Stability	±0.50ppm				1
Temperature Range	0 to 70°C				

Model Number	TFLD6E	TFHD6E	TVLD6E	TVHD6E	TABLE 6 NOTE
Supply Voltage	3.3 Vdc	5.0 Vdc	3.3 Vdc	5.0 Vdc	
TCXO / VCTCXO	TCXO	TCXO	VCTCXO	VCTCXO	
Frequency Range	6.4 to 52 MHz				
Frequency Stability	±0.50ppm				1
Temperature Range	-40 to 85°C				

Model Number	TFLD5F	TFHD5F	TVLD5F	TVHD5F	TABLE 7 NOTE
Supply Voltage	3.3 Vdc	5.0 Vdc	3.3 Vdc	5.0 Vdc	
TCXO / VCTCXO	TCXO	TCXO	VCTCXO	VCTCXO	
Frequency Range	6.4 to 52 MHz				
Frequency Stability	±1.00ppm				1
Temperature Range	0 to 70°C				

Model Number	TFLD6F	TFHD6F	TVLD6F	TVHD6F	TABLE 8 NOTE
Supply Voltage	3.3 Vdc	5.0 Vdc	3.3 Vdc	5.0 Vdc	
TCXO / VCTCXO	TCXO	TCXO	VCTCXO	VCTCXO	
Frequency Range	6.4 to 52 MHz				
Frequency Stability	±1.00ppm				1
Temperature Range	-40 to 85°C				

Notes:

- 1) Frequency stability vs. change in temperature. $[\pm(F_{max} - F_{min})/2.F_0]$.
- 2) Inclusive of frequency stability, supply voltage change (±5%), aging, for 24 hours.

Ordering Information

TFLD5C - 010.0 M
 TCXO SERIES CENTER FREQUENCY

US Headquarters:
 630-851-4722
 European Headquarters:
 +353-61-472221

Bulletin	Tx134
Page	2 of 4
Revision	05
Date	16 Apr 2007

Electrical Specifications for all Models

ABSOLUTE MAXIMUM RATINGS

TABLE 9

PARAMETER	UNITS	MINIMUM	NOMINAL	MAXIMUM	UNITS	NOTE
Storage Temperature		-55	-	125	°C	
Supply Voltage	(Vcc)	-0.5	-	6.0	Vdc	
Input Voltage		-0.5	-	Vcc+0.6	Vdc	

OPERATING SPECIFICATIONS

TABLE 10

PARAMETER		MINIMUM	NOMINAL	MAXIMUM	UNITS	NOTE
TCXO Frequency Calibration @ 25°C		-1.00	-	1.00	ppm	3
Total Frequency Tolerance		-4.60	-	4.60	ppm	4
Supply Voltage	3.3Vdc (Vcc)	3.135	3.3	3.465	Vdc	
	5.0Vdc (Vcc)	4.75	5.0	5.25	Vdc	
Supply Current	(Icc)	-	6	10	mA	
Jitter (BW=10Hz to 20MHz)		-	-	5	ps rms	
Jitter (BW=12kHz to 20MHz)		-	-	1	ps rms	
SSB Phase Noise at 10Hz offset		-	-80	-	dBc/Hz	
SSB Phase Noise at 100Hz offset		-	-110	-	dBc/Hz	
SSB Phase Noise at 1KHz offset		-	-135	-	dBc/Hz	
SSB Phase Noise at >10KHz offset		-	-150	-	dBc/Hz	
SSB Phase Noise at >100KHz offset		-	-150	-	dBc/Hz	

INPUT CHARACTERISTICS for ENABLE / DISABLE FUNCTION (Pin 2)

TABLE 11

PARAMETER		MINIMUM	NOMINAL	MAXIMUM	UNITS	NOTE
Enable Voltage (High) or open circuit	(Vih)	70% Vdd	-	-	Vdc	5
Disable Voltage (Low) Output Tri-stated	(Vil)	-	-	30% Vdd	Vdc	

VCTCXO INPUT CHARACTERISTICS for VOLTAGE CONTROL (Pin1)

TABLE 12

PARAMETER		MINIMUM	NOMINAL	MAXIMUM	UNITS	NOTE
Control Voltage Range (Vcc = 3.3V)	(Vc)	0.3	1.65	3.0	Vdc	
Control Voltage Range (Vcc = 5.0V)	(Vc)	0.5	2.5	4.5	Vdc	
Frequency Tuning		±10	-	-	ppm	6
Linearity		±5	-	-	%	
Slope			Positive			

CMOS OUTPUT CHARACTERISTICS

TABLE 13

PARAMETER		MINIMUM	NOMINAL	MAXIMUM	UNITS	NOTE
LOAD		-	-	15	pF	
Voltage (High)	(Voh)	90%Vcc	-	-	Vdc	
(Low)	(Vol)	-	-	10%Vcc	Vdc	
Current (High)	(Ioh)	-4	-	-	mA	
(Low)	(Iol)	-	-	4	mA	
Duty Cycle at 50% of Vcc		45	50	55	%	
Rise / Fall Time 10% to 90%		-	-	8	ns	

Notes:

- TCXO: Initial calibration @ 25°C. Specifications at time of shipment after 48 hours of operation.
- Inclusive of calibration, operating temperature range, supply voltage change, shock and vibration and aging (10 years).
- Leave Pad 2 unconnected if enable / disable function is not required. When tri-stated, the output stage is disabled but the oscillator and compensation circuit are still active (current consumption ≤ 1 mA).
- Additional pull ranges are available; please contact the factory for additional information.



Features

TCXO or VCTCXO
 3.3V or 5.0V Operation
 LVCMOS or HCMOS Output Logic
 Frequency Stabilities Available:
 ±0.25ppm
 ±0.28ppm
 ±0.50ppm
 ±1.00ppm
 Temperature Ranges Available:
 0 to 70°C
 -40 to 85°C
 Low Jitter < 1ps RMS
 Tri-State Enable/Disable
 Surface Mount Package
 Tape and Reel Packaging
 RoHS Compliant / Lead Free

Ordering Information

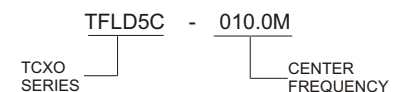

US Headquarters:
 630-851-4722
 European Headquarters:
 +353-61-472221

Bulletin	Tx134
Page	3 of 4
Revision	05
Date	16 Apr 2007

PACKAGE CHARACTERISTICS

Package	FR4 Surface Mount Package.
---------	----------------------------

TABLE 14

ENVIRONMENTAL CHARACTERISTICS

Vibration:	Vibration per Mil Std 883E Method 2007.3 Test Condition A
Shock:	Mechanical Shock per Mil Std 883E Method 2002.4 Test Condition B.
Soldering:	SMD product suitable for Convection Reflow soldering. Peak temperature 260°C. Maximum time above 220°C, 60 seconds.
Solderability	Solderability per Mil Std 883E Method 2003

TABLE 15

Pin Connections

Pin	Connection
1	N/C or Voltage Control
2	Enable / Disable
3	Ground (Cover)
4	Output
5	N/C
6	Supply, Vcc

Package Outline

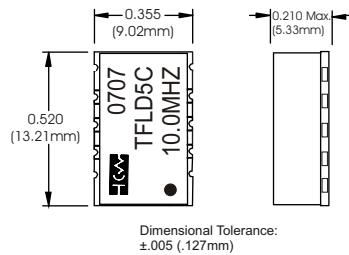

Suggested Pad Layout

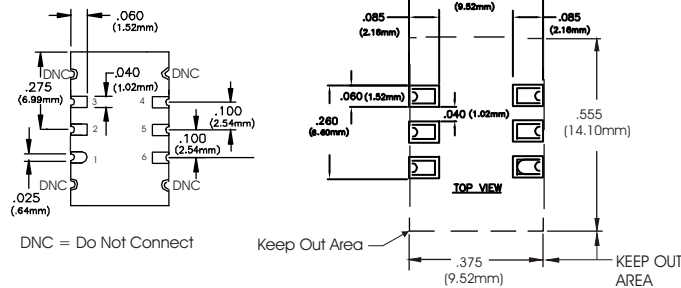

Solder Profile

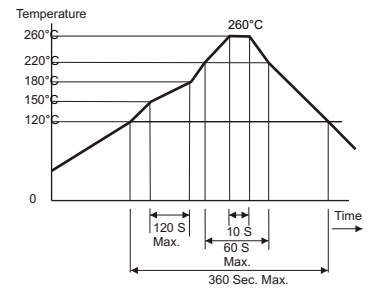

Test Circuit

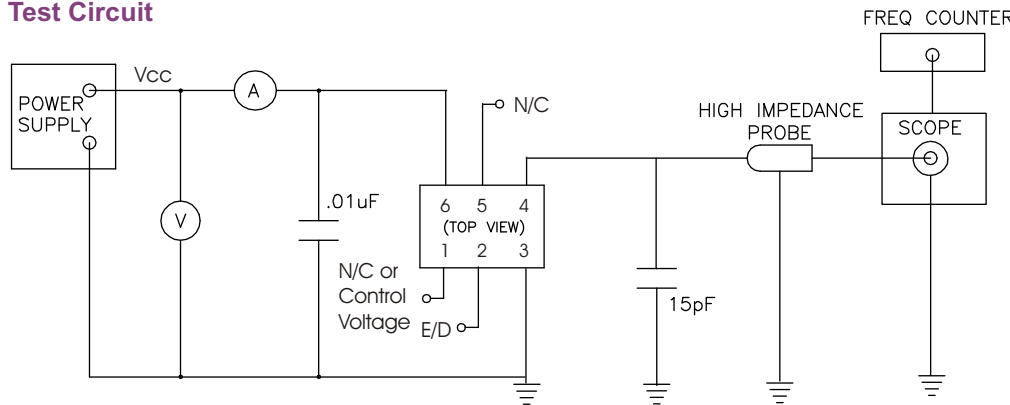

Output Waveform

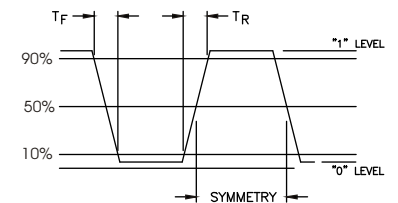

Tape and Reel Information

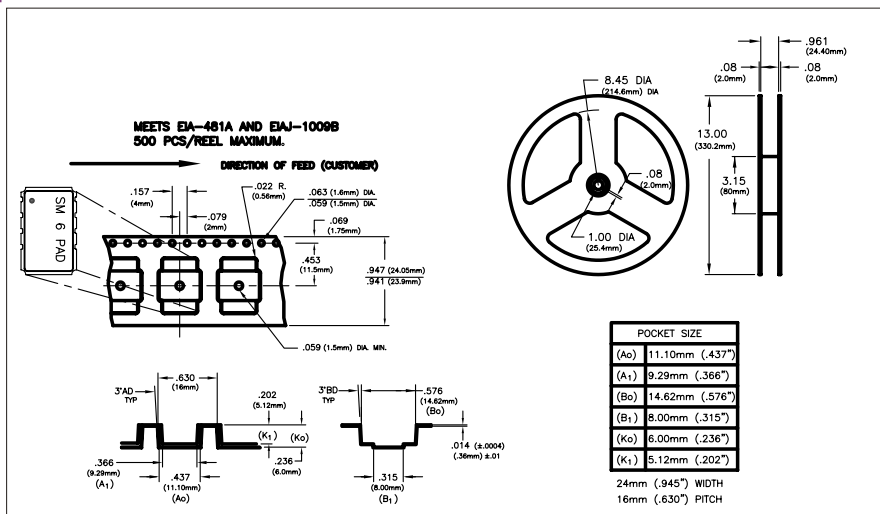

Ordering Information

TFLD5C - 010.0 M

TCXO SERIES

CENTER FREQUENCY

US Headquarters:
630-851-4722
European Headquarters:
+353-61-472221

Bulletin	Tx134
Page	4 of 4
Revision	05
Date	16 Apr 2007