

# AP4002T

**RoHS-compliant Product**



**Advanced Power  
Electronics Corp.**

*N-CHANNEL ENHANCEMENT MODE*

*POWER MOSFET*

- ▼ 100% Avalanche Test
- ▼ Fast Switching Characteristics
- ▼ Simple Drive Requirement

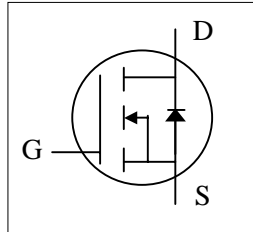

$BV_{DSS}$	600V
$R_{DS(ON)}$	5 $\Omega$
$I_D$	400mA

## Description

Advanced Power MOSFETs utilized advanced processing techniques to achieve the lowest possible on-resistance, extremely efficient and cost-effectiveness device.

The TO-92 package is widely used for commercial-industrial applications.

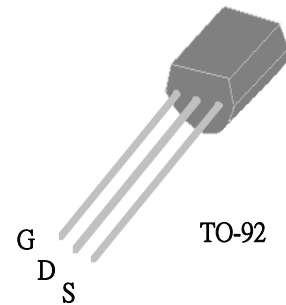

## Absolute Maximum Ratings

Symbol	Parameter	Rating	Units
$V_{DS}$	Drain-Source Voltage	600	V
$V_{GS}$	Gate-Source Voltage	$\pm 30$	V
$I_D@T_L=25^\circ C$	Continuous Drain Current, $V_{GS}$ @ 10V	400	mA
$I_{DM}$	Pulsed Drain Current <sup>1</sup>	3	A
$P_D@T_L=25^\circ C$	Total Power Dissipation	2	W
	Linear Derating Factor	0.017	W/ $^\circ C$
$E_{AS}$	Single Pulse Avalanche Energy <sup>2</sup>	20	mJ
$I_{AR}$	Avalanche Current	2	A
$T_{STG}$	Storage Temperature Range	-55 to 150	$^\circ C$
$T_J$	Operating Junction Temperature Range	-55 to 150	$^\circ C$

## Thermal Data

Symbol	Parameter	Value	Unit
Rthj-a	Maximum Thermal Resistance, Junction-ambient	150	$^\circ C/W$
Rthj-l	Maximum Thermal Resistance, Junction-lead	60	$^\circ C/W$



**Electrical Characteristics @ $T_j=25^{\circ}\text{C}$ (unless otherwise specified)**

Symbol	Parameter	Test Conditions	Min.	Typ.	Max.	Units
$BV_{DSS}$	Drain-Source Breakdown Voltage	$V_{GS}=0V, I_D=1mA$	600	-	-	V
$R_{DS(ON)}$	Static Drain-Source On-Resistance	$V_{GS}=10V, I_D=400mA$	-	-	5	$\Omega$
$V_{GS(th)}$	Gate Threshold Voltage	$V_{DS}=V_{GS}, I_D=250\mu A$	2	-	4	V
$g_{fs}$	Forward Transconductance	$V_{DS}=10V, I_D=400mA$	-	570	-	mS
$I_{DSS}$	Drain-Source Leakage Current	$V_{DS}=600V, V_{GS}=0V$	-	-	100	$\mu A$
$I_{GSS}$	Gate-Source Leakage	$V_{GS}=\pm 30V$	-	-	$\pm 1$	$\mu A$
$Q_g$	Total Gate Charge <sup>3</sup>	$I_D=2A$	-	12	19	nC
$Q_{gs}$	Gate-Source Charge	$V_{DS}=480V$	-	2	-	nC
$Q_{gd}$	Gate-Drain ("Miller") Charge	$V_{GS}=10V$	-	5.5	-	nC
$t_{d(on)}$	Turn-on Delay Time <sup>3</sup>	$V_{DD}=200V$	-	10	-	ns
$t_r$	Rise Time	$I_D=1A$	-	12	-	ns
$t_{d(off)}$	Turn-off Delay Time	$R_G=50\Omega, V_{GS}=10V$	-	52	-	ns
$t_f$	Fall Time	$R_D=200\Omega$	-	19	-	ns
$C_{iss}$	Input Capacitance	$V_{GS}=0V$	-	375	600	pF
$C_{oss}$	Output Capacitance	$V_{DS}=10V$	-	170	-	pF
$C_{riss}$	Reverse Transfer Capacitance	$f=1.0MHz$	-	45	-	pF

**Source-Drain Diode**

Symbol	Parameter	Test Conditions	Min.	Typ.	Max.	Units
$V_{SD}$	Forward On Voltage <sup>3</sup>	$T_j=25^{\circ}\text{C}, I_S=2A, V_{GS}=0V$	-	-	1.5	V
$t_{rr}$	Reverse Recovery Time <sup>3</sup>	$I_S=2A, V_{GS}=0V,$	-	340	-	ns
$Q_{rr}$	Reverse Recovery Charge	$di/dt=100A/\mu s$	-	2.2	-	$\mu C$

**Notes:**

- 1.Pulse width limited by Max. junction temperature.
- 2.Starting  $T_j=25^{\circ}\text{C}$  ,  $V_{DD}=50V$  ,  $L=10mH$  ,  $R_G=25\Omega$
- 3.Pulse test

THIS PRODUCT IS AN ELECTROSTATIC SENSITIVE, PLEASE HANDLE WITH CAUTION.

THIS PRODUCT HAS BEEN QUALIFIED FOR CONSUMER MARKET. APPLICATIONS OR USES AS CRITERIAL COMPONENT IN LIFE SUPPORT DEVICE OR SYSTEM ARE NOT AUTHORIZED.

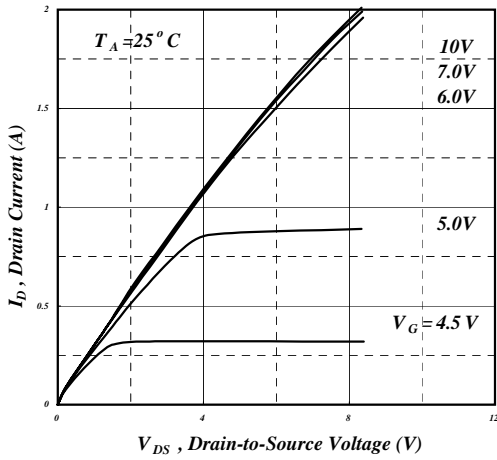

Fig 1. Typical Output Characteristics

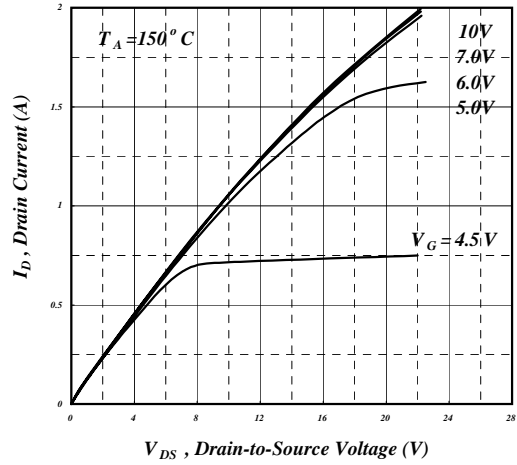

Fig 2. Typical Output Characteristics

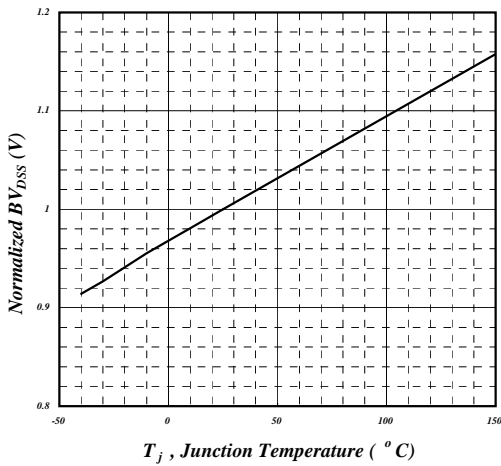

Fig 3. Normalized  $BV_{DSS}$  v.s. Junction Temperature

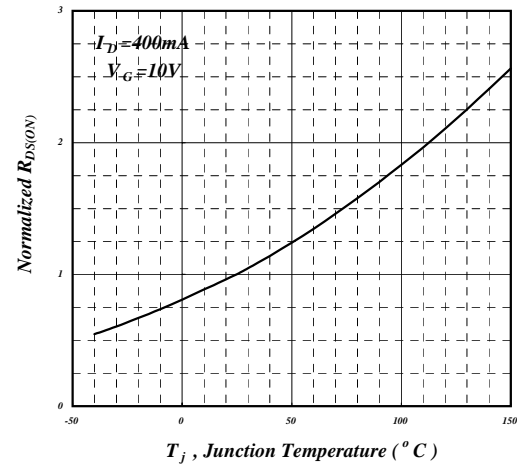

Fig 4. Normalized On-Resistance v.s. Junction Temperature

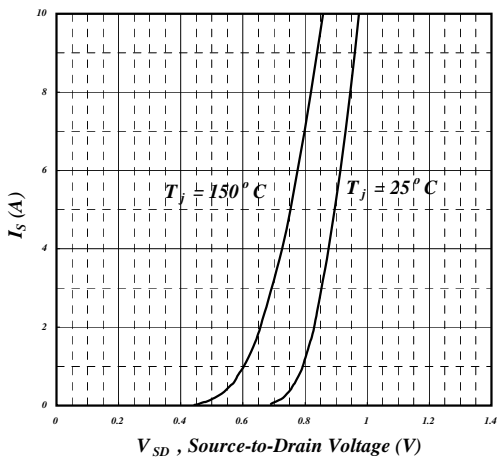

Fig 5. Forward Characteristic of Reverse Diode

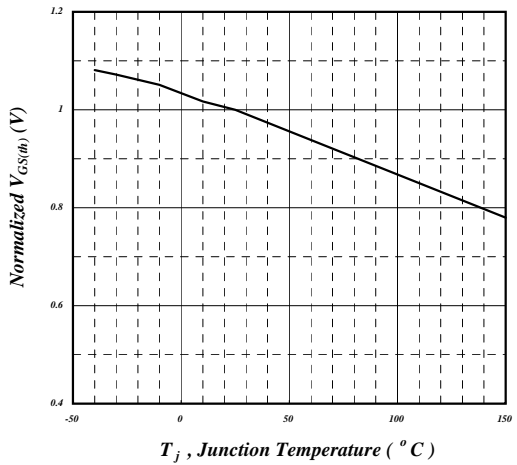

Fig 6. Gate Threshold Voltage v.s. Junction Temperature

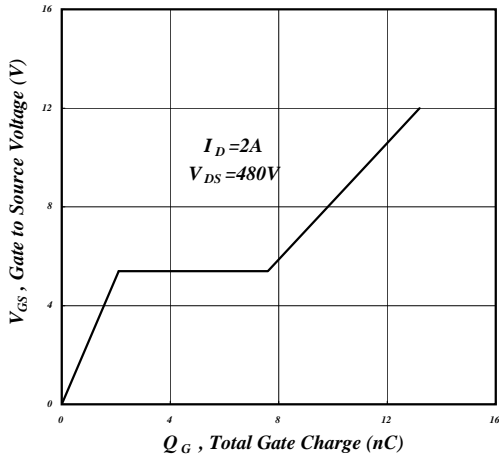

Fig 7. Gate Charge Characteristics

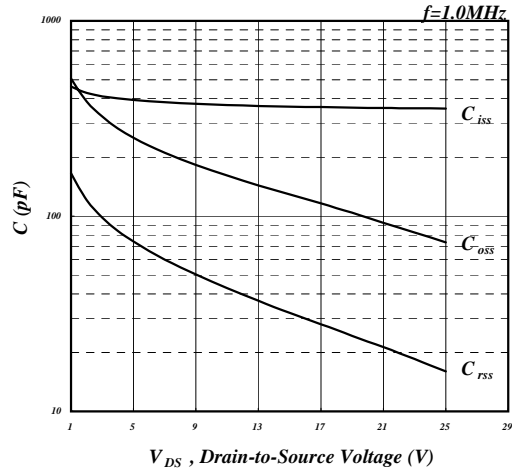

Fig 8. Typical Capacitance Characteristics

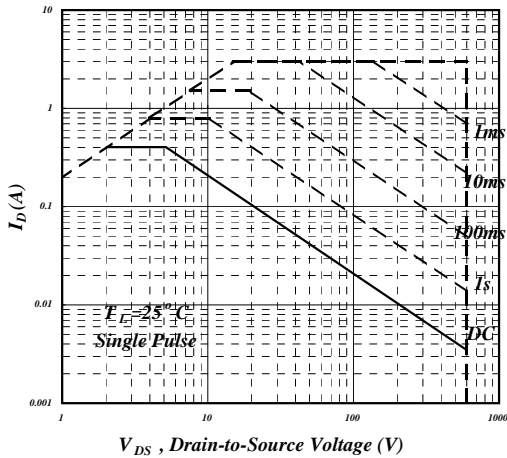

Fig 9. Maximum Safe Operating Area

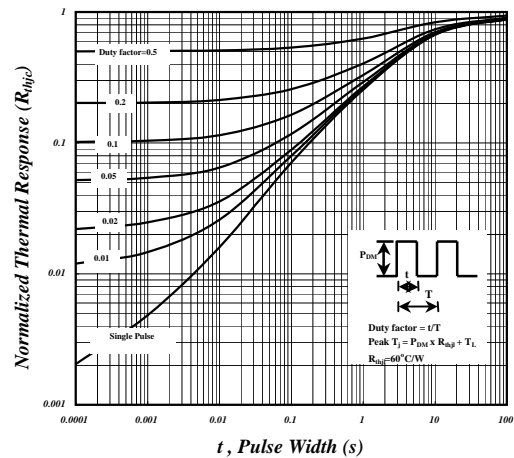

Fig 10. Effective Transient Thermal Impedance

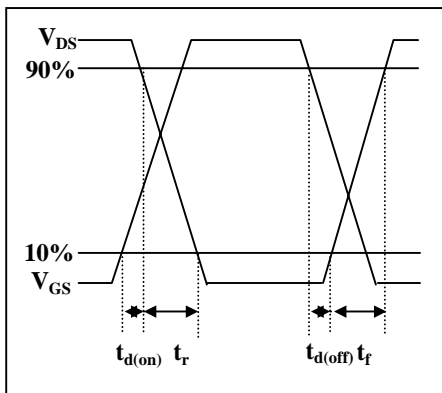

Fig 11. Switching Time Waveform

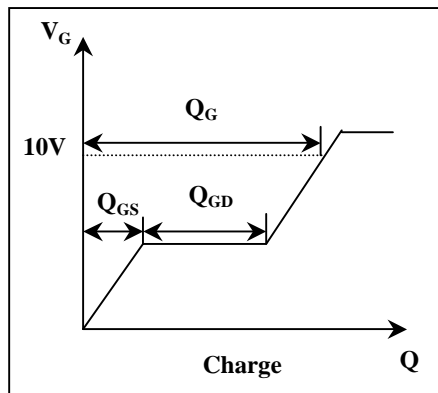
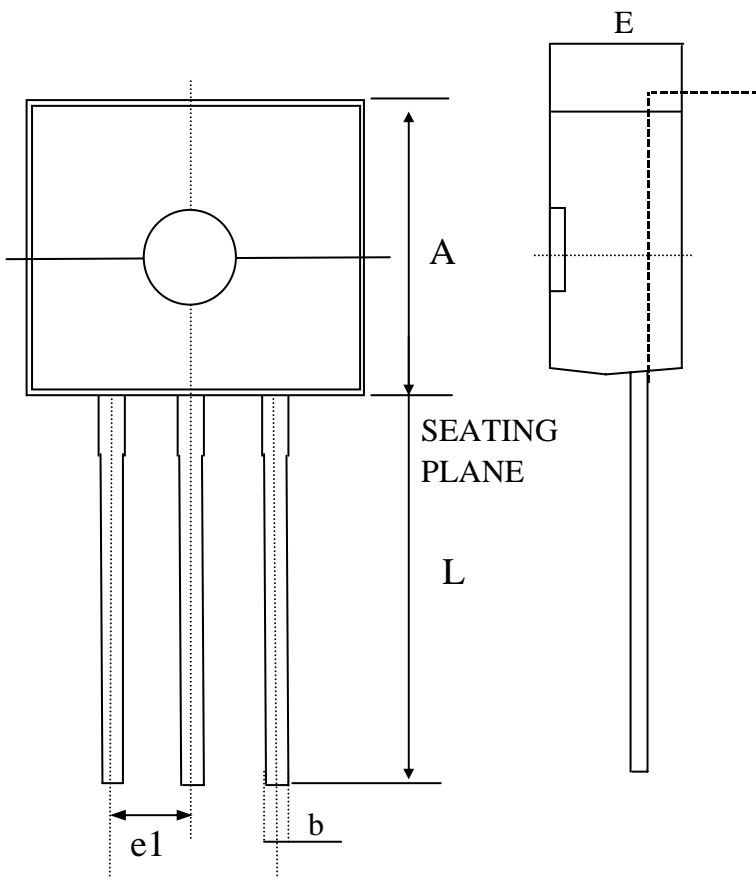

Fig 12. Gate Charge Waveform



### Package Outline : TO-92



SYMBOL	Millimeters		
	MIN	NOM	MAX
A	4.32	4.83	5.34
D	4.1	4.8	5.3
E	3.1	3.9	4.7
b	----	0.38	----
L	12.7	---	----
e1	----	1.27	----

1. All Dimensions Are in Millimeters.
2. Dimension Does Not Include Mold Protrusions.

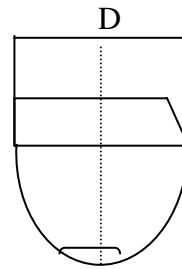

### Part Marking Information & Packing : TO-92

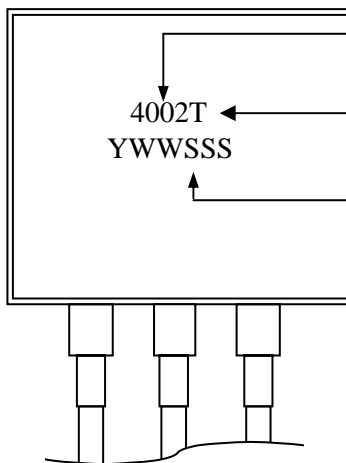

Part Number

4002T  
YWWSSS

Package Code

Date Code (YWWSSS)

Y : Last Digit Of The Year

WW : Week

SSS : Sequence