

## FEATURES

- Low Noise Charge Pump Provides High Efficiency with Automatic Mode Switching
- Multimode Operation: 1x, 1.5x, 2x
- Full-Scale Current Set Resistor
- Up to 125mA Total LED Current
- Single Wire Enable/Brightness Control for Main and Sub Display LEDs
- 32:1 Linear LED Brightness Control
- Dual 200mA Linear Regulators
- Four 25mA Low Dropout Main LED Current Sources
- One 25mA Low Dropout Sub LED Current Source
- Low Noise Constant Frequency Operation
- Low Shutdown Current: 3 $\mu$ A
- Internal Soft-Start Limits Inrush Current During Start-Up and Mode Switching
- Open/Short LED Protection
- No Inductors
- 20-Lead 3mm  $\times$  3mm QFN Package

## APPLICATIONS

- Multi-LED Driver and Dual LDO Supplies for Cell Phone, PDA, Digital Camera and PND Applications

**LT**, **LT**, **LTC** and **LTM** are registered trademarks of Linear Technology Corporation. All other trademarks are the property of their respective owners. Protected by U.S. Patents including 6411531.

## DESCRIPTION

The LTC<sup>®</sup>3230 is a low noise charge pump DC/DC converter designed to drive 4 Main LEDs and 1 Sub LED, plus two 200mA linear regulators to provide additional system power. The LTC3230 charge pump requires only four small ceramic capacitors and one current set resistor to form a complete LED power supply and current controller.

Built-in soft-start circuitry prevents excessive inrush current during start-up and mode changes. High switching frequency enables the use of small external capacitors. Main and Sub full-scale current settings are programmed by a single external resistor.

Charge pump efficiency is optimized based on the voltage across the LED current sources. The part powers up in 1x mode and automatically switches to the next higher mode, 1.5x and subsequently 2x, whenever any LED current source approaches dropout.

Two 200mA linear regulators have independent enable and output voltage select pins. Each regulator can be set to one of three pre-selected output voltages with tri-level input pins. The regulators may be enabled independently of the charge pump.

The LTC3230 is available in a low profile (0.75mm) 3mm  $\times$  3mm 20-lead QFN package.

## TYPICAL APPLICATION

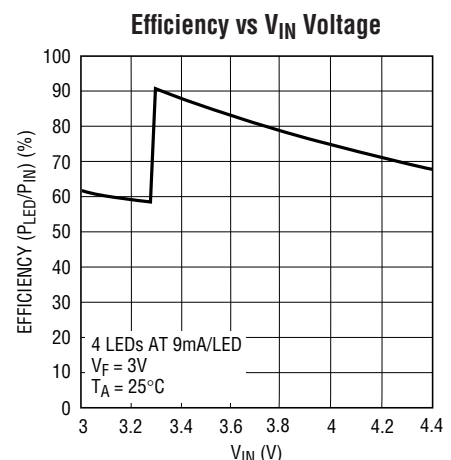
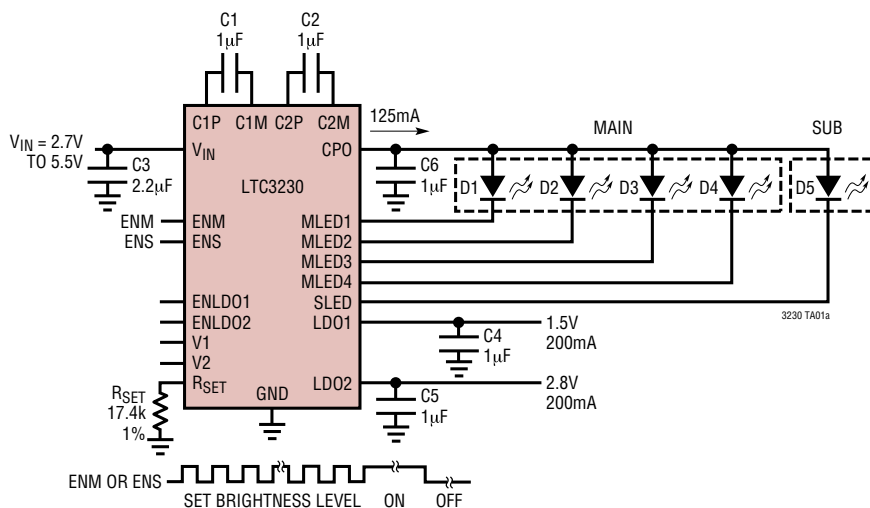

3230 TAO1b

3230fa

## ABSOLUTE MAXIMUM RATINGS

(Notes 1-5)

$V_{IN}$ , CPO.....	-0.3V to 6V
ENM, ENS, ENLDO1, ENLDO2, V1, V2, LDO1, LDO2 .....	-0.3V to ( $V_{IN} + 0.3V$ )
$I_{CPO}$ (Note 2).....	200mA
LDO1, LDO2 (Note 3).....	200mA
MLED1-4, SLED, $R_{SET}$ .....	-0.3V to 6V
Operating Ambient Temperature Range (Note 4).....	-40°C to 85°C
Junction Temperature .....	125°C
Storage Temperature Range.....	-65°C to 150°C

## PIN CONFIGURATION

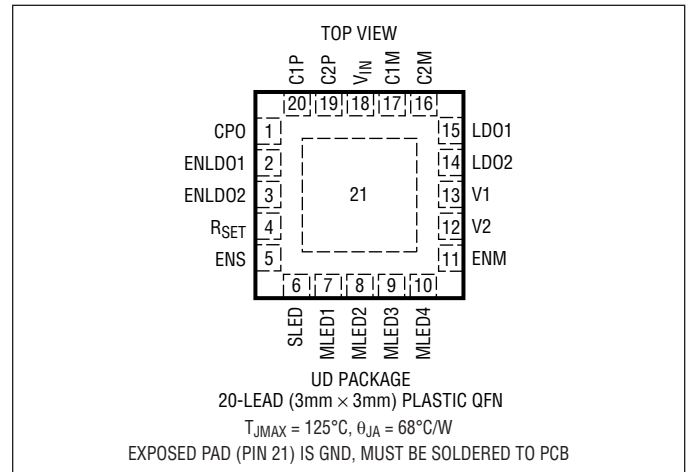

## ORDER INFORMATION

LEAD FREE FINISH	TAPE AND REEL	PART MARKING	PACKAGE DESCRIPTION	TEMPERATURE RANGE
LTC3230EUD#PBF	LTC3230EUD#TRPBF	LCYB	20-Lead (3mm × 3mm) Plastic QFN	-40°C to 85°C

Consult LTC Marketing for parts specified with wider operating temperature ranges.

Consult LTC Marketing for information on non-standard lead based finish parts.

For more information on lead free part marking, go to: <http://www.linear.com/leadfree/>

For more information on tape and reel specifications, go to: <http://www.linear.com/tapeandreeel/>

## ELECTRICAL CHARACTERISTICS

The ● denotes the specifications which apply over the full operating temperature range, otherwise specifications are at  $T_A = 25^{\circ}C$ .  $V_{IN} = 3.6V$ ,  $C1 = C2 = C4 = C5 = C6 = 1\mu F$ ,  $R_{SET} = 17.4k$ ,  $ENM = ENS = \text{high}$ ,  $ENLDO1 = ENLDO2 = \text{low}$ , unless otherwise noted.

PARAMETER	CONDITIONS	MIN	TYP	MAX	UNITS
$V_{IN}$ Operating Voltage		● 2.7		5.5	V
$I_{VIN}$ Operating Current	$I_{CPO} = 0$ , 1x Mode		0.48		mA
	$I_{CPO} = 0$ , 1.5x Mode		1.2		mA
	$I_{CPO} = 0$ , 2x Mode		1.6		mA
$V_{IN}$ Shutdown Current	ENM = ENS = ENLDO2 = ENLDO1 = Low	●	3	9	$\mu A$
<b>MLED1, MLED2, MLED3, MLED4 and SLED Currents</b>					
LED Current Ratio ( $I_{LED}/I_{RSET}$ )			555		A/A
LED Dropout Voltage	Mode Switch Threshold, $I_{MLED} = 15mA$		100		mV
LED Current Matching	Any Two MLED Outputs, $I_{MLED} = \text{Full Scale}$		0.5		%
MLED/SLED Current, 5-Bit Linear DAC	1 ENM/ENS Strobe (FS)		25.5		mA
	31 ENM/ENS Strobes (FS/31)		0.860		mA
<b>Unused LED Detection</b>					
Threshold Voltage	$V_{CPO} - MLED$	●	200	780	mV
Test Current	LED Tied to CPO	●	39	178	$\mu A$

**ELECTRICAL CHARACTERISTICS** The ● denotes the specifications which apply over the full operating temperature range, otherwise specifications are at  $T_A = 25^\circ\text{C}$ .  $V_{IN} = 3.6\text{V}$ ,  $C1 = C2 = C4 = C5 = C6 = 1\mu\text{F}$ ,  $R_{SET} = 17.4\text{k}$ ,  $ENM = ENS = \text{high}$ ,  $ENLDO1 = ENLDO2 = \text{low}$ , unless otherwise noted.

PARAMETER	CONDITIONS		MIN	TYP	MAX	UNITS
<b>CPO Short Circuit Detection</b>						
Threshold Voltage		●	0.4		1.3	V
<b>Charge Pump (CPO)</b>						
1x Mode Output Voltage	$I_{CPO} = 0\text{mA}$			$V_{IN}$		V
1.5x Mode Output Voltage	$I_{CPO} = 0\text{mA}$			4.5		V
2x Mode Output Voltage	$I_{CPO} = 0\text{mA}$			5.0		V
1x Mode Output Impedance				1.6		$\Omega$
1.5x Mode Output Impedance	$V_{IN} = 3.4\text{V}$ , $V_{CPO} = 4.6\text{V}$ (Note 6)			7.9		$\Omega$
2x Mode Output Impedance	$V_{IN} = 3.4\text{V}$ , $V_{CPO} = 5.1\text{V}$ (Note 6)			9.2		$\Omega$
Clock Frequency				0.9		MHz
Mode Switching Delay				0.5		ms
$t_{EN}$	Current Source Enable Time (ENM, ENS = High) (Note 7)	●			250	$\mu\text{s}$
<b>LD01, LD02</b>						
Bias per 1 LDO	$ENM = ENS = \text{Low}$			125		$\mu\text{A}$
Additional DC Bias per LDO				60		$\mu\text{A}$
Output Voltage Accuracy	$I_{OUT} = 100\mu\text{A}$	●	-3		3	%
Current Limit		●	280	475	750	mA
Line Regulation	$V_{LDO} = 1.8\text{V}$ , $I_{OUT} = 50\text{mA}$			0.1		%/V
Load Regulation	$V_{IN} = 3.6\text{V}$ , $100\mu\text{A} < I_{LDO} < 200\text{mA}$			0.65		%
Dropout Voltage	LD02, $V_{LDO} = 3.3\text{V}$ , $V_{IN} - V_{LDO}$ at $V_{LDO}$ 3% Down from $V_{LDO}$ Measured at $V_{IN} = 4.3\text{V}$			250		mV
<b>V1, V2</b>						
$V_{IL}$		●			0.2	V
$V_{IH}$		●	$V_{IN} - 0.2$			V
Shutdown Input Current	$ENLDO1 = ENLDO2 = \text{Low}$		-1		1	$\mu\text{A}$
Active Input Current	$ENLDO1 = ENLDO2 = \text{High}$		-3		3	$\mu\text{A}$
<b>ENM, ENS, ENLDO1, ENLDO2</b>						
$V_{IL}$		●			0.4	V
$V_{IH}$		●	1.4			V
$I_{IH}$	$V_{IH} = 3.6\text{V}$			3		$\mu\text{A}$
$I_{IL}$	$V_{IL} = 0\text{V}$	●	-1		1	$\mu\text{A}$
<b>ENM, ENS Timing</b>						
$t_{PWH}$	High Pulse Width	●	0.2			$\mu\text{s}$
$t_{PWL}$	Low Pulse Width		0.2		20	$\mu\text{s}$
$t_{SD}$	Low Time to Shutdown (ENM, ENS = Low)	●	250			$\mu\text{s}$
<b>RSET</b>						
$V_{RSET}$		●	768	800	832	mV
$I_{RSET}$		●			70	$\mu\text{A}$

## ELECTRICAL CHARACTERISTICS

**Note 1:** Stresses beyond those listed under Absolute Maximum Ratings may cause permanent damage to the device. Exposure to any Absolute Maximum Rating condition for extended periods may affect device reliability and lifetime.

**Note 2:** Based on long-term current density limitations. Assumes an operating duty cycle of  $\leq 10\%$  under absolute maximum conditions for durations less than 10 seconds. Maximum current for continuous operation is 125mA.

**Note 3:** Based on long-term current density limitations. LD01 and LD02 have short circuit protection which limits current to no more than 750mA. Assumes an operating short circuit duty cycle less than 3% for durations less than 10 seconds.

**Note 4:** The LTC3230 is guaranteed to meet performance specifications from  $0^{\circ}\text{C}$  to  $85^{\circ}\text{C}$ . Specifications over the  $-40^{\circ}\text{C}$  to  $85^{\circ}\text{C}$  ambient operating temperature range are assured by design, characterization and correlation with statistical process controls.

**Note 5:** This IC includes overtemperature protection that is intended to protect the device during momentary overload conditions. Junction temperature will exceed  $125^{\circ}\text{C}$  when overtemperature protection is active. Continuous operation above the specified maximum operating junction temperature may result in device degradation or failure.

**Note 6:** 1.5x mode output impedance is defined as  $(1.5V_{\text{IN}} - V_{\text{CPO}})/I_{\text{OUT}}$ . 2x mode output impedance is defined as  $(2V_{\text{IN}} - V_{\text{CPO}})/I_{\text{OUT}}$ .

**Note 7:** If the part has been shut down then the initial enable time is about  $100\mu\text{s}$  longer due to the bandgap start-up and charge pump soft-start times.

## TYPICAL PERFORMANCE CHARACTERISTICS $T_A = 25^{\circ}\text{C}$ unless otherwise noted.

Dropout Time from Enable

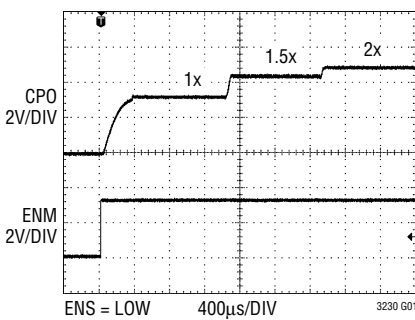

Dropout Time when Enabled

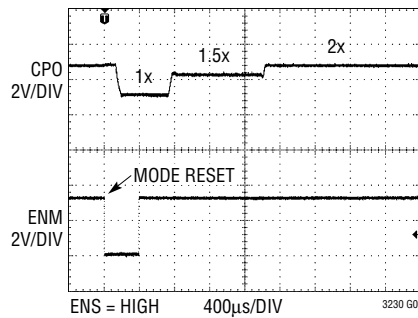

1.5x CPO Ripple

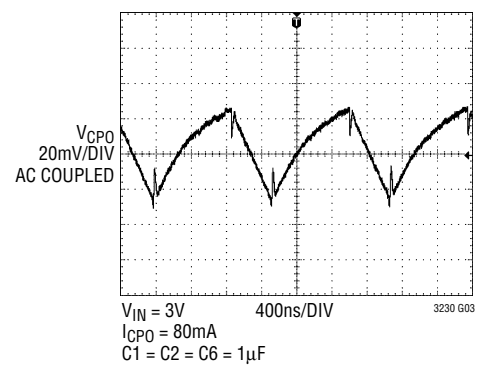

2x CPO Ripple

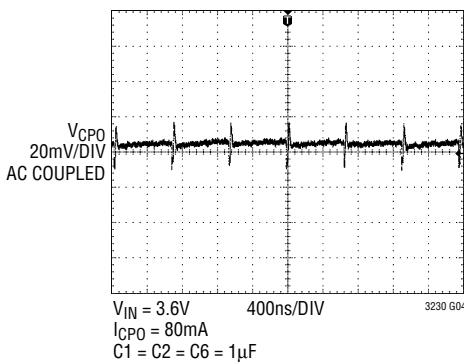

1x Mode Switch Resistance vs Temperature

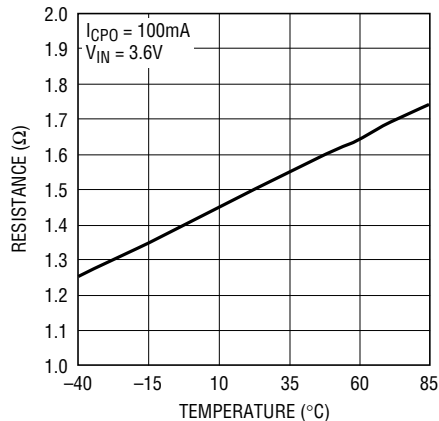

1.5x Mode Charge Pump Open-Loop Output Resistance vs Temperature  $(1.5V_{\text{IN}} - V_{\text{CPO}})/I_{\text{CPO}}$

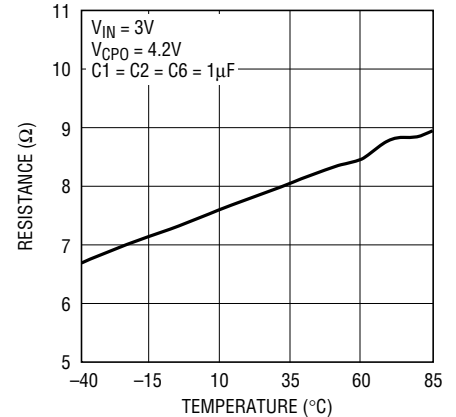

# TYPICAL PERFORMANCE CHARACTERISTICS

**1.5x Mode CPO Voltage vs Load Current**

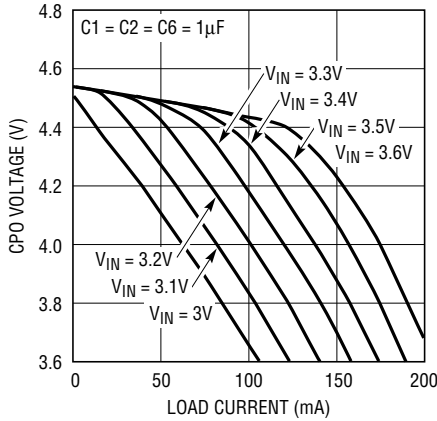

3230 G07

**2x Mode Charge Pump Open-Loop Output Resistance vs Temperature**  
( $2V_{IN} - V_{CPO}$ )/ $I_{CPO}$

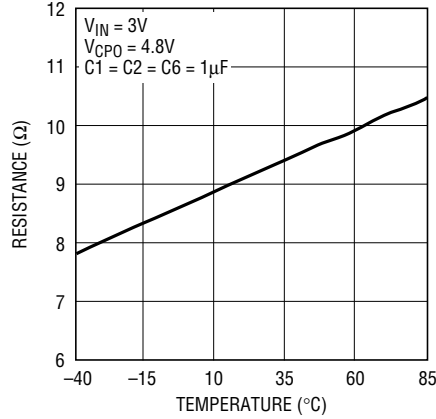

3230 G08

**2x Mode CPO Voltage vs Load Current**

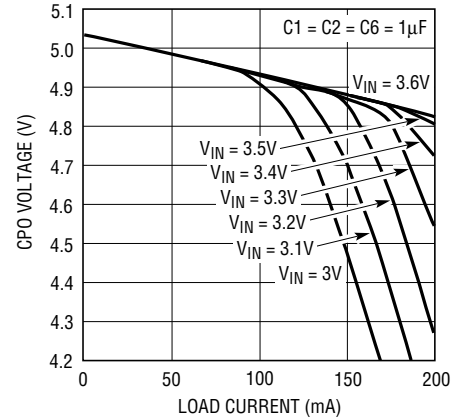

3230 G09

**MLED/SLED Pin Dropout Voltage vs MLED/SLED Pin Current**

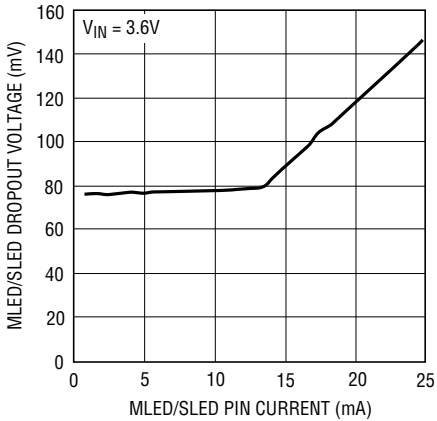

3230 G10

**Oscillator Frequency vs VIN Voltage**

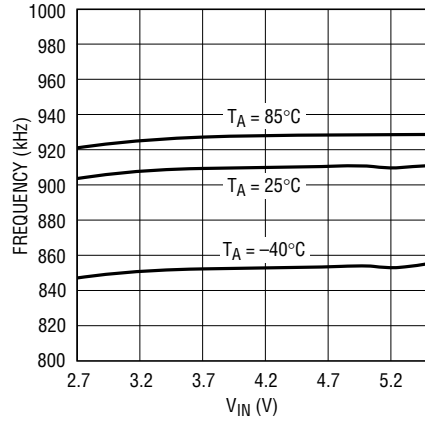

3230 G11

**VIN Shutdown Current vs VIN Voltage**

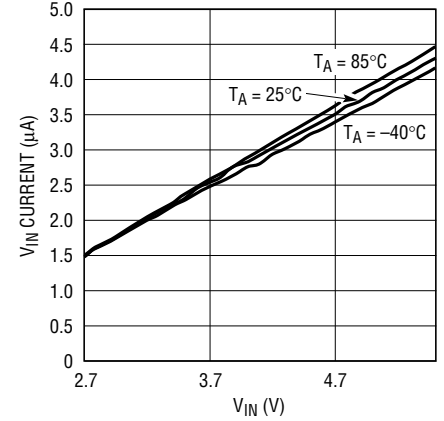

3230 G12

**1x Mode No-Load VIN Current vs VIN Voltage**

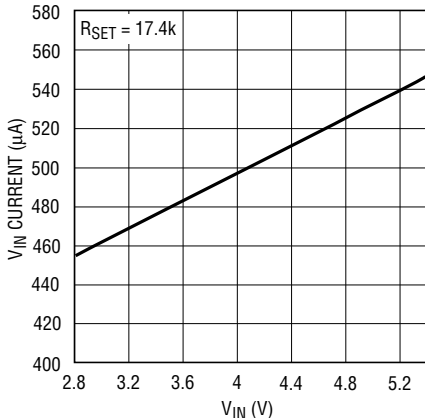

3230 G13

**1.5x Mode Supply Current vs ICPO**  
( $I_{VIN} - 1.5I_{CPO}$ )

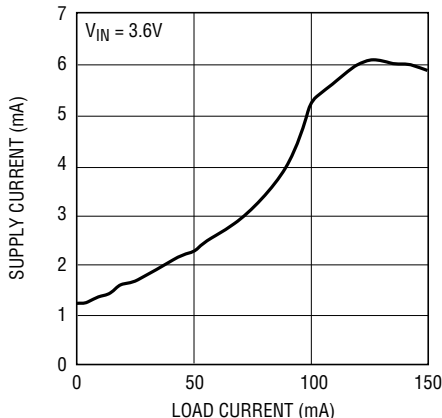

3230 G14

**2x Mode Supply Current vs ICPO**  
( $I_{VIN} - 2I_{CPO}$ )

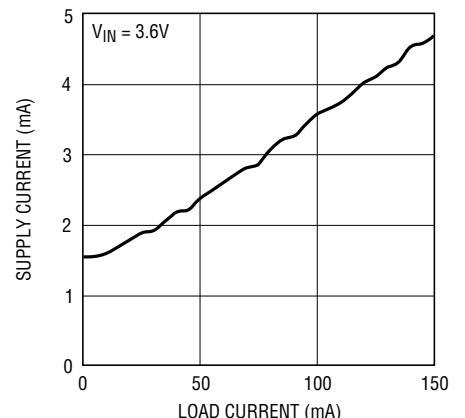

3230 G15

3230fa

## TYPICAL PERFORMANCE CHARACTERISTICS

**MLED/SLED Pin Current vs MLED/SLED Pin Voltage**

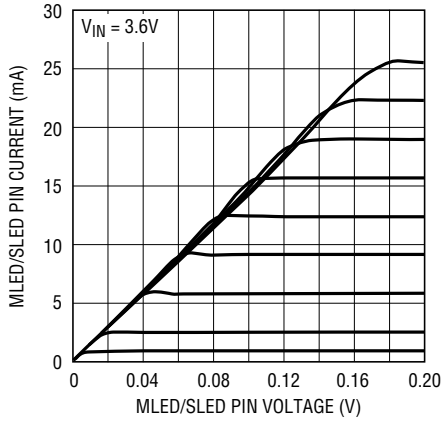

3230 G16

**MLED/SLED Current vs ENM/ENS Strobe Pulses**

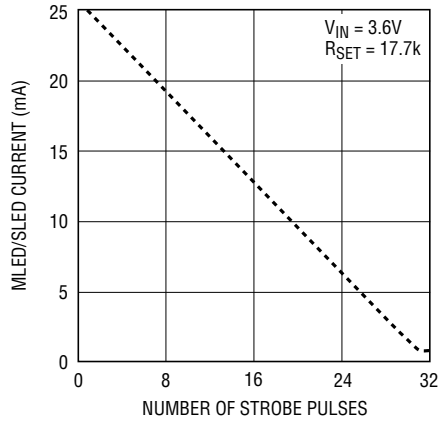

3230 G17

**Efficiency vs VIN Voltage**

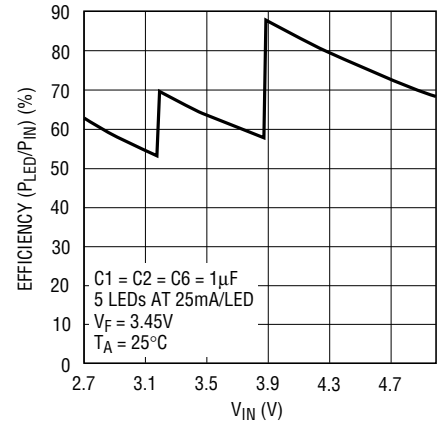

3230 G18

**LD02 Dropout Voltage vs Load Current**

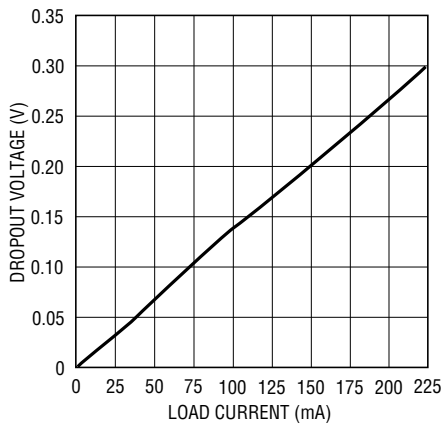

3230 G19

**Output Voltage Accuracy vs Load Current**

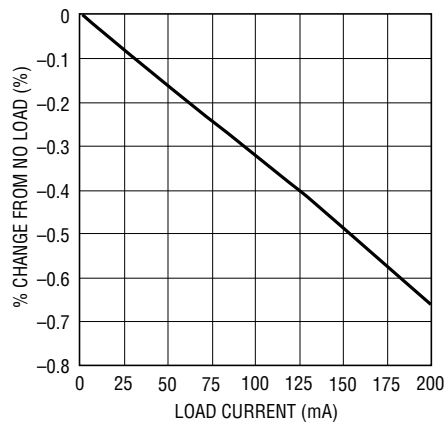

3230 G20

**LD01 and LD02 Load Transient Response**

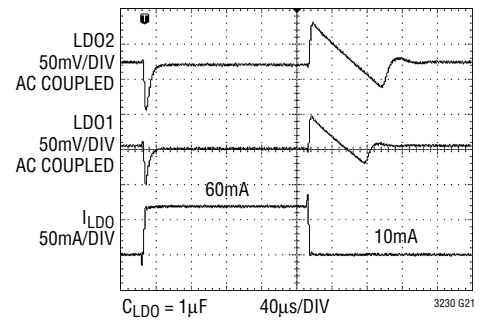

3230 G21

**Output Voltage Accuracy vs Temperature**

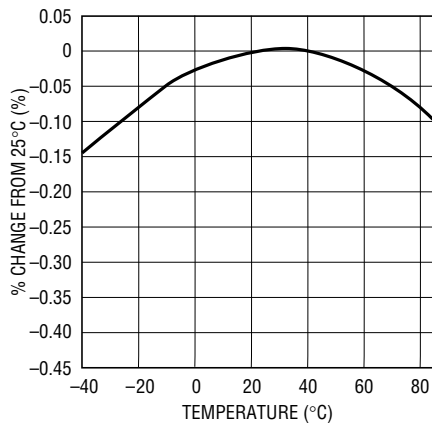

3230 G22

**LD01 and LD02 Current Limit vs Temperature**

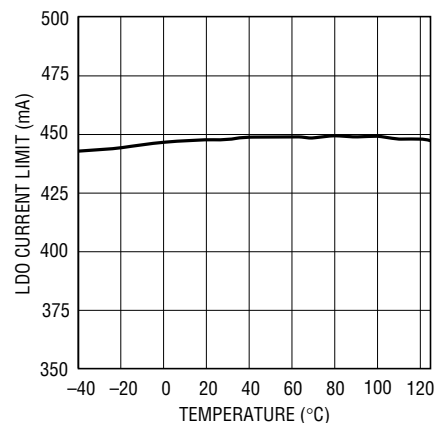

3230 G23

## PIN FUNCTIONS

**CPO (Pin 1):** Output of the Charge Pump Used to Power All LEDs. This pin is enabled or disabled using the ENM and ENS inputs. A 1 $\mu$ F X5R or X7R ceramic capacitor should be connected to ground.

**ENLD01, ENLD02 (Pins 2, 3):** LDO1 and LDO2 Enables. Logic-level high enables LDO1 or LDO2. Logic-level low disables LDO1 or LDO2.

**R<sub>SET</sub> (Pin 4):** LED Current Programming Resistor Pin. The R<sub>SET</sub> pin will servo to 0.8V. A resistor connected between R<sub>SET</sub> and GND is used to set the MLED and SLED full-scale current level. Connecting a resistor 10k or less will cause the LTC3230 to enter overcurrent shutdown.

**ENS, ENM (Pins 5, 11):** SLED and MLED Enable and Output Control. The ENS and ENM pins are used to program the LED output currents. Pulse the ENS pin up to 31 times to decrement the internal 5-bit DAC which controls the Sub LED current from full scale to one LSB. Pulse the ENM pin up to 31 times to decrement the internal 5-bit DAC which controls the MLED1-4 LED currents from full scale to one LSB. The counters will stop at 1LSB when the number of strobes exceeds 31. The pin must be held high after the desired positive strobe edge and the data is transferred after a 150 $\mu$ s (typical) delay. Holding the ENS or ENM pin low will clear the counter for the selected display and reset the LED current to zero. If both inputs are held low for longer than 150 $\mu$ s (typical), the charge pump and LED current sources will go into shutdown. The charge pump mode is reset to 1x whenever ENS or ENM is held low or when the part is shut down.

**SLED (Pin 6):** SLED Current Driver. SLED is the Sub current source output. The LED is connected between CPO (anode) and SLED (cathode). The current to the LED output is set via the ENS input.

**MLED1, MLED2, MLED3, MLED4 (Pins 7, 8, 9, 10):** MLED1-4 Current Drivers. MLED1 to MLED4 are the Main current source outputs. The LEDs are connected between CPO (anodes) and MLED1-4 (cathodes). The current to the LED outputs are set via the ENM input. Any of the four LED outputs can be disabled by connecting the output directly to CPO. A 100 $\mu$ A current will flow through each directly connected LED output.

**V2, V1 (Pins 12, 13):** LDO Output Voltage Select. V1 is used to set LDO1's output voltage. V2 is used to set LDO2's output voltage. Tie to V<sub>IN</sub>, GND or float. LDO Output voltages set by V1 and V2 are shown below.

<b>V1</b>	GND	FLOAT	V <sub>IN</sub>
<b>LD01 (V)</b>	1.2	1.5	1.8
<b>V2</b>	GND	FLOAT	V <sub>IN</sub>
<b>LD02 (V)</b>	1.8	2.8	3.3

**LD02, LD01 (Pins 14, 15):** LDO Outputs. Bypass LDO1 and LDO2 with 1 $\mu$ F X5R or X7R ceramic capacitors to GND.

**C2M, C1M, C2P, C1P (Pins 16, 17, 19, 20):** Charge Pump Flying Capacitor Pins. 1 $\mu$ F X5R or X7R ceramic capacitors should be connected from C1P to C1M and from C2P and C2M.

**V<sub>IN</sub> (Pin 18):** Supply Voltage. This pin should be bypassed with a 2.2 $\mu$ F or greater low ESR ceramic capacitor.

**Exposed Pad (Pin 21):** Ground. This pad must be connected directly to a low impedance ground plane for proper thermal and electrical performance.

**BLOCK DIAGRAM**

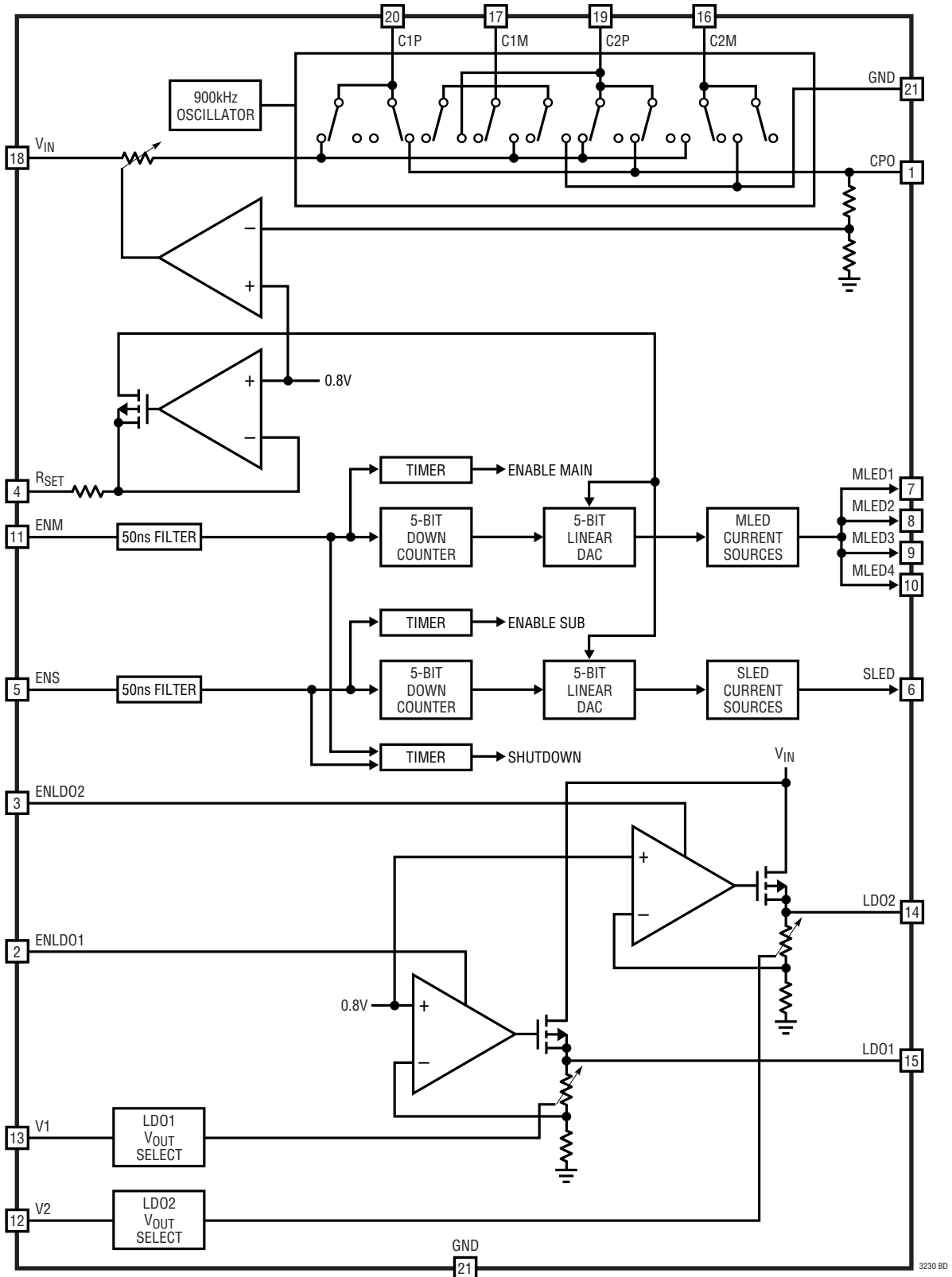

3230 BD



## OPERATION

### Power Management

The LTC3230 uses a switched capacitor charge pump to boost CPO to as much as 2 times the input voltage up to 5V. The part starts up in 1x mode. In this mode,  $V_{IN}$  is connected directly to CPO. 1x mode provides maximum efficiency and minimum noise. The LTC3230 will remain in 1x mode until any LED current source drops out. Dropout occurs when a current source voltage becomes too low for the programmed current to be supplied. When dropout is detected, the LTC3230 will switch into 1.5x mode. The CPO voltage will then start to increase and will attempt to reach  $1.5x V_{IN}$  up to 4.5V. Any subsequent dropout will cause the part to enter 2x mode. The CPO voltage will attempt to reach  $2x V_{IN}$  up to 5V. The part will be reset to 1x mode whenever the part is shut down or when either ENM or ENS is driven low.

A 2-phase non-overlapping clock activates the charge pump switches. In 2x mode the flying capacitors are charged on alternate clock phases from  $V_{IN}$  to minimize CPO voltage ripple. In 1.5x mode the flying capacitors are charged in series during the first clock phase and stacked in parallel on  $V_{IN}$  during the second phase. This sequence of charging and discharging the flying capacitors continues at a constant frequency of 900kHz.

### LED Current Control

The MLED and SLED currents are delivered by programmable current sources controlled by the ENM and ENS

pins and by the value of the resistor on the  $R_{SET}$  pin. There are four MLED current sources controlled by the ENM pin and one SLED current source controlled by the ENS pin. Full-scale current in the MLED and SLED pins are set by a resistor from the  $R_{SET}$  pin to GND according to the following formula:

$$\text{MLED/SLED Full-Scale Output Current} = \frac{0.8}{R_{SET}} \cdot 555$$

Thirty two linear current settings are available by applying up to 31 pulses when enabling the ENM and ENS pins. Each strobe counts down a 5-bit DAC to set the LED current. When the desired count is reached, leave the enable strobe high and the output current will be set to the programmed value after a typical delay of  $150\mu\text{s}$ . If more than 31 strobes are received the counter will stop at one LSB. The output current will be set to zero if the enable is set low only after the  $150\mu\text{s}$  delay. If the enable is toggled before the  $150\mu\text{s}$  delay, the DAC counter will continue to count down and the current output will not be enabled until the start-up delay is finished.

When both ENM and ENS are held low for more than  $250\mu\text{s}$  (minimum) the LED drivers and charge pump will go into shutdown. See Figure 1 for timing information. If the charge pump is in either 1.5x or 2x modes, the falling edge of either ENM or ENS will reset the charge pump to 1x mode.

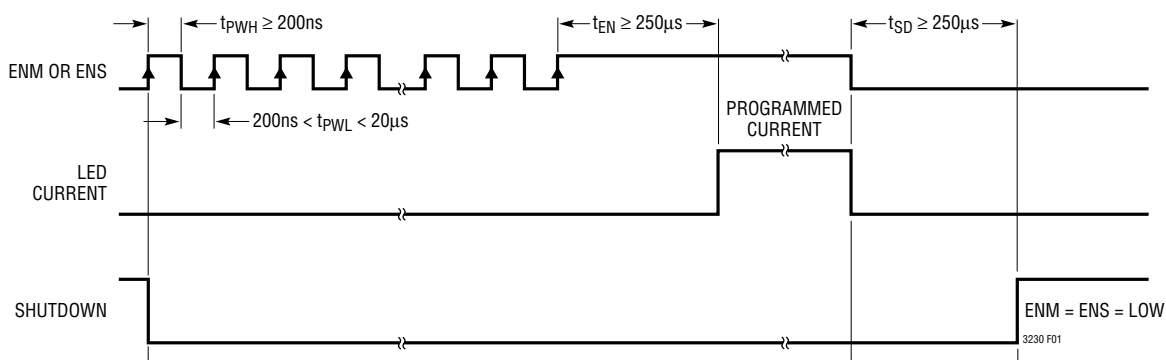

Figure 1. Current Programming Timing Diagram

## OPERATION

### Charge Pump Soft-Start

In shutdown, CPO is disconnected from  $V_{IN}$  and is pulled down through a 14.3k resistor. When enabled, a weak switch connects  $V_{IN}$  to CPO. This allows  $V_{IN}$  to slowly charge the CPO output to prevent large charging currents.

The LTC3230 also employs a soft-start feature on its charge pump to prevent excessive inrush current and supply droop when switching into the step-up modes. The current available to the CPO pin is increased linearly over a typical period of 50 $\mu$ s. Soft-start occurs at the start of both 1.5x and 2x modes.

### Charge Pump Strength and Regulation

Regulation is achieved by sensing the voltage at the CPO pin and modulating the charge pump strength based on the error signal. The CPO regulation voltages are set internally, and are dependent on the charge pump modes as shown in Table 1.

**Table 1. Charge Pump Output Regulation Voltages**

CHARGE PUMP MODE	REGULATED $V_{CPO}$
1.5x	4.5V
2x	5V

When the LTC3230 operates in either 1.5x mode or 2x mode, the charge pump can be modeled as a Thevenin equivalent circuit to determine the amount of current available from the effective input voltage and effective open-loop output resistance,  $R_{OL}$  (Figure 2).

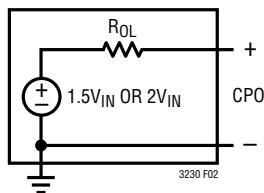

**Figure 2. Charge Pump Thevenin Equivalent Open-Loop Circuit**

$R_{OL}$  is dependent on a number of factors including the switching term,  $1/(2 \cdot f_{OSC} \cdot C_{FLY})$ , internal switch resistances and the non-overlap period of the switching circuit. However, for a given  $R_{OL}$ , the amount of current available will be directly proportional to the advantage voltage of

$1.5 \cdot V_{IN} - CPO$  for 1.5x mode and  $2 \cdot V_{IN} - CPO$  for 2x mode. Consider the example of driving white LEDs from a 3.1V supply. If the LED forward voltage is 3.8V and the current sources require 100mV, the advantage voltage for 1.5x mode is  $3.1V \cdot 1.5 - 3.8V - 0.1V$  or 750mV. Notice that if the input voltage is raised to 3.2V, the advantage voltage jumps to 900mV – a 20% improvement in available strength.

From Figure 2, for 1.5x mode the available current is given by:

$$I_{OUT} = \frac{1.5 \cdot V_{IN} - V_{CPO}}{R_{OL}}$$

For 2x mode, the available current is given by:

$$I_{OUT} = \frac{2 \cdot V_{IN} - V_{CPO}}{R_{OL}}$$

Notice that the advantage voltage in this case is  $3.1V \cdot 2 - 3.8V - 0.1V = 2.3V$ .  $R_{OL}$  is higher in 2x mode but a significant increase in available current is achieved.

Typical values of  $R_{OL}$  as a function of temperature are shown in Figures 3 and 4.

### Mode Switching

The LTC3230 will automatically switch from 1x mode to 1.5x mode and subsequently to 2x mode whenever a dropout condition is detected at any LED pin. Dropout occurs when a current source voltage becomes too low for the programmed current to be supplied. The time from dropout detection to mode switching is typically 0.5ms.

The charge pump mode is reset back to 1x when the LED drivers are shut down ( $ENM = ENS = Low$ ) or on the falling edge of either ENM or ENS. An internal comparator will not allow the main switches to connect  $V_{IN}$  and CPO in 1x mode until the voltage at the CPO pin has decayed to less than or equal to the voltage at the  $V_{IN}$  pin.

### LDO Operation

Two independent low drop-out linear regulators are in the LTC3230. Each regulator may be independently enabled (ENLDO1 and ENLDO2) from each other and from the

## OPERATION

charge pump function. Driving ENLDO1 and ENLDO2 high enable LDO1 and LDO2 respectively. When the charge pump is enabled, each LDO consumes an additional 60 $\mu$ A (typical) from  $V_{IN}$ . If the charge pump is not enabled, one LDO consumes 125 $\mu$ A (typical) and the second uses 60 $\mu$ A (typical) additional current.

LDO output voltage is set using three-level input pins V1 and V2 as shown in Table 2.

**Table 2. LDO1 and LDO2 Output Voltage Control**

V1	GND	FLOAT	$V_{IN}$
LDO1 (V)	1.2	1.5	1.8
V2	GND	FLOAT	$V_{IN}$
LDO2 (V)	1.8	2.8	3.3

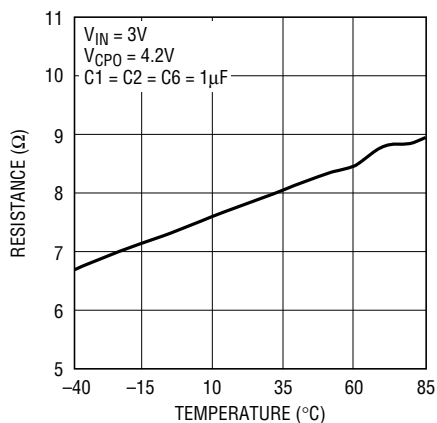

3230 G06

**Figure 3. Typical 1.5x  $R_{OL}$  vs Temperature**

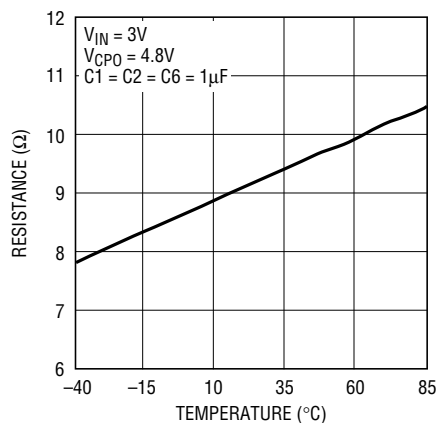

3230 G08

**Figure 4. Typical 2x  $R_{OL}$  vs Temperature**

The reference input to each LDO is ramped when enabled to provide an output soft-start lasting typically 100 $\mu$ s. When an LDO is disabled its output is pulled to ground through an 11.5k resistor.

### Shutdown Current

In shutdown mode all the circuitry is turned off and the LTC3230 draws a very low current from the  $V_{IN}$  supply. When in shutdown, CPO is disconnected from  $V_{IN}$  and is pulled to ground through a 14.3k resistor. The LTC3230 enters shutdown mode when both ENM and ENS pins are brought low for 250 $\mu$ s (minimum) and ENLDO1 and ENLDO2 are brought low. All enable pins ENM, ENS, ENLDO1 and ENLDO2 have internal pull-downs to define the shutdown state whenever the inputs are floating.

## APPLICATIONS INFORMATION

### $V_{IN}$ and CPO Capacitor Selection

The style and value of the capacitors used with the LTC3230 determine several important parameters such as regulator control loop stability, output ripple, charge pump strength and minimum start-up time.

To reduce noise and ripple, it is recommended that low equivalent series resistance (ESR) ceramic capacitors are used on both  $V_{IN}$  and CPO. Tantalum and aluminum capacitors are not recommended due to high ESR.

The value of  $C_{CPO}$  directly controls the amount of output ripple for a given load current. Increasing the size of  $C_{CPO}$  will reduce the output ripple but will increase start-up time. The peak-to-peak output ripple of the 1.5x mode is approximately given by the expression:

$$V_{RIPPLE(P-P)} = \frac{I_{OUT}}{3 \cdot f_{OSC} \cdot C_{CPO}}$$

where  $f_{OSC}$  is the oscillator frequency, typically 900kHz, and  $C_{CPO}$  is the output storage capacitor.

The output ripple in 2x mode is very small due to the fact that load current is supplied on both cycles of the clock.

Both style and value of the output capacitor can significantly affect the stability of the LTC3230. As shown in the Block Diagram, the LTC3230 uses a control loop to adjust the strength of the charge pump to match the required output current. The error signal for the loop is stored directly on the output capacitor. The output capacitor also serves as the dominant pole for the control loop. To prevent ringing or instability, it is important for the output capacitor to maintain at least 0.6 $\mu$ F of capacitance over all conditions.

In addition, excessive output capacitor ESR >100m $\Omega$  will tend to degrade the loop stability. Multilayer ceramic chip capacitors typically have exceptional ESR performance and when combined with a tight board layout will result in very good stability. As the value of  $C_{CPO}$  controls the amount of output ripple, the value of  $C_{VIN}$  controls the amount of ripple present at the input pin ( $V_{IN}$ ). The LTC3230's input current will be relatively constant while the charge pump is either in the input charging phase or the output charging phase but will drop to zero during the clock overlapping

times. Since the nonoverlapping time is small (~10ns), these missing “notches” will result in only a small perturbation on the input power supply line. Note that a higher ESR capacitor such as tantalum will cause a higher input noise due to the higher ESR. Input noise can be further reduced by powering the LTC3230 through a very small series inductor as shown in Figure 5. A 10nH inductor will reject the fast current notches, thereby presenting a nearly constant current load to the input power supply.

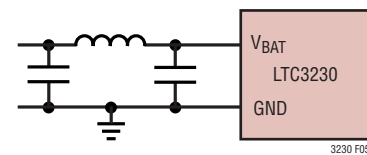

Figure 5. 10nH Inductor Used for Input Noise Reduction

### Flying Capacitor Selection

**Warning: Polarized capacitors such as tantalum or aluminum should never be used for the flying capacitors since their voltage can reverse upon start-up of the LTC3230. Ceramic capacitors should always be used for the flying capacitors.**

The flying capacitors control the strength of the charge pump. In order to achieve the rated output current it is necessary to have at least 0.6 $\mu$ F of capacitance for each of the flying capacitors. Capacitors of different materials lose their capacitance with higher temperature and voltage at different rates. For example, a ceramic capacitor made of X7R material will retain most of its capacitance from -40°C to 85°C, whereas a Z5U or Y5V style capacitor will lose considerable capacitance over that range. Capacitors may also have a very poor voltage coefficient causing them to lose 60% or more of their capacitance when the rated voltage is applied. Therefore, when comparing different capacitors, it is often more appropriate to compare the amount of achievable capacitance for a given case size rather than comparing the specified capacitance value. For example, over rated voltage and temperature conditions, a 1 $\mu$ F, 10V, Y5V ceramic capacitor in a 0603 case may not provide any more capacitance than a 0.22 $\mu$ F, 10V, X7R available in the same case. The capacitor manufacturer's data sheet should be consulted to determine what value

## APPLICATIONS INFORMATION

of capacitor is needed to ensure minimum capacitances at all temperatures and voltages.

Table 3 shows a list of ceramic capacitor manufacturers and how to contact them.

**Table 3. Recommended Capacitor Vendors**

AVX	www.avxcrp.com
Kemet	www.kemet.com
Murata	www.murata.com
Taiyo Yuden	www.t-yuden.com
Vishay	www.vishay.com

### Layout Considerations and Noise

Due to the high switching frequency and the transient currents produced by the LTC3230, careful board layout is necessary. A true ground plane and short connections to all capacitors will improve performance and ensure proper regulation under all conditions.

The flying capacitor pins C1P, C2P, C1M and C2M will have high edge rate waveforms. The large dv/dt on these pins can couple energy to adjacent PCB runs. Magnetic fields can also be generated if the flying capacitors are not close to the LTC3230 (i.e., the loop area is large). To decouple capacitive energy transfer, a grounded PCB trace between the sensitive node and the LTC3230 pins will shield the sensitive node. For a high quality AC ground, the shield trace should be returned to a solid ground plane that extends all the way to the LTC3230.

The following guidelines should be followed when designing a PCB layout for the LTC3230:

- The Exposed Pad should be soldered to a large copper plane that is connected to a solid, low impedance ground plane using plated through hole vias for proper heat sinking and noise protection.
- Input and output capacitors must be placed close to the part.
- The flying capacitors must be placed close to the part. The traces from the pins to the capacitor pad should be as wide as possible.
- $V_{IN}$  and CPO traces must be wide to minimize inductance and handle high currents.

- LED pads must be large and connected to the other layers of metal to ensure proper heat sinking.
- The  $R_{SET}$  pin is sensitive to noise and capacitance. The resistor should be placed near the part with minimum line width.

### Power Efficiency

To calculate the power efficiency ( $\eta$ ) of a white LED driver chip, the LED power should be compared to the input power. The difference between these two numbers represents lost power whether it is in the charge pump or the current sources. Stated mathematically, the power efficiency is given by:

$$\eta = \frac{P_{LED}}{P_{IN}}$$

The efficiency of the LTC3230 depends upon the mode in which it is operating. Recall that the LTC3230 operates as a pass switch, connecting  $V_{IN}$  to CPO, until dropout is detected at a LED pin. This feature provides the optimum efficiency available for a given input voltage and LED forward voltage. When it is operating as a switch, the efficiency is approximated by:

$$\eta = \frac{P_{LED}}{P_{IN}} = \frac{V_{LED} \cdot I_{LED}}{V_{IN} \cdot I_{IN}} = \frac{V_{LED}}{V_{IN}}$$

since the input current will be very close to the sum of the LED currents.

At moderate to high output power, the quiescent current of the LTC3230 is negligible and the expression above is valid.

Once dropout is detected at any LED pin, the LTC3230 enables the charge pump in 1.5x mode.

In 1.5x boost mode, the efficiency is similar to that of a linear regulator with an effective input voltage of 1.5 times the actual input voltage. This is because the input current for a 1.5x charge pump is approximately 1.5 times the load current. In an ideal 1.5x charge pump, the power efficiency would be given by:

$$\eta = \frac{P_{LED}}{P_{IN}} = \frac{V_{LED} \cdot I_{LED}}{V_{IN} \cdot 1.5 \cdot I_{IN}} = \frac{V_{LED}}{1.5 \cdot V_{IN}}$$

## APPLICATIONS INFORMATION

In 2x boost mode as well, the efficiency is similar to that of a linear regulator with an effective input voltage of 2 times the actual input voltage. In an ideal 2x charge pump, the power efficiency would be given by:

$$\eta = \frac{P_{LED}}{P_{IN}} = \frac{V_{LED} \cdot I_{LED}}{V_{IN} \cdot 2 \cdot I_{IN}} = \frac{V_{LED}}{2 \cdot V_{IN}}$$

### Thermal Management

For higher input voltages and maximum output current, there can be substantial power dissipation in the LTC3230. If the junction temperature increases above approximately 150°C the thermal shutdown circuitry will automatically deactivate the output current sources, charge pump and both LDOs. To reduce maximum junction temperature, a good thermal connection to the PC board is recommended. Connecting the Exposed Pad to a ground plane and maintaining a solid ground plane under the device will reduce the thermal resistance of the package and PC board considerably.

Its built-in thermal shutdown circuitry will protect the LTC3230 from short term transient events. For continuous operation the maximum rated junction temperature is 125°C. The power dissipated by the device is made up of three components:

1. The LTC3230  $I_{VIN}$  operating current (found in the Electrical Characteristics table) multiplied by  $V_{IN}$ .

$$P_Q = I_Q \cdot V_{IN}$$

2. The sum of the LED currents multiplied by the difference between  $V_{IN} \cdot \text{Mode}$  and the LED forward voltage where Mode is 1, 1.5 or 2 depending on the charge pump mode.

$$P_{CP} = (V_{IN} \cdot \text{Mode} - V_{LED}) \cdot I_{LEDTOTAL}$$

3. For each LDO, the product of the LDO output current and the difference between  $V_{IN}$  and the LDO.

$$P_{LDO} = (V_{IN} - V_{LDO1}) \cdot I_{LDO1} + (V_{IN} - V_{LDO2}) \cdot I_{LDO2}$$

Given a thermal resistance,  $\theta_{JA}$ , for the LTC3230 QFN package of 68°C/W, at an ambient temperature of 70°C the total power in the LTC3230 should be kept to less than 815mW. Applications in which the LDO output voltages are set to the lower range and which use a high  $V_{IN}$  input voltage may require limiting the total current output to keep  $T_J$  less than 125°C at the upper ambient temperature corners.

An example using the parameters in Table 4 shows an application that just meets the maximum junction temperature limit. An increase in  $V_{IN}$ , for example, will require reducing the output current of the charge pump or LDO.

**Table 4.  $T_J$  Calculation Example Parameters**

$V_{IN}$	3.6V
Mode	1.5x
$V_{LED}$	3.3V
$I_{LEDTOTAL}$	100mA (20mA/LED)
$V_{LDO1}$	1.5V
$V_{LDO2}$	2.8V
$I_{LDO1}$	200mA
$I_{LDO2}$	200mA
$\theta_{JA}$	68°C/W
$T_A$	70°C
Total Power Dissipation	799mW
Internal Junction Temperature	124°C

# PACKAGE DESCRIPTION

**UD Package**  
**20-Lead Plastic QFN (3mm × 3mm)**  
 (Reference LTC DWG # 05-08-1720 Rev A)

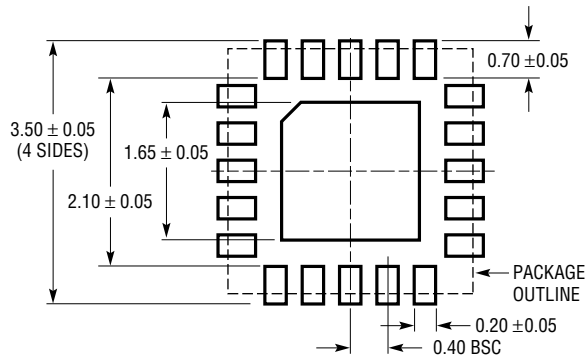

RECOMMENDED SOLDER PAD PITCH AND DIMENSIONS  
 APPLY SOLDER MASK TO AREAS THAT ARE NOT SOLDERED

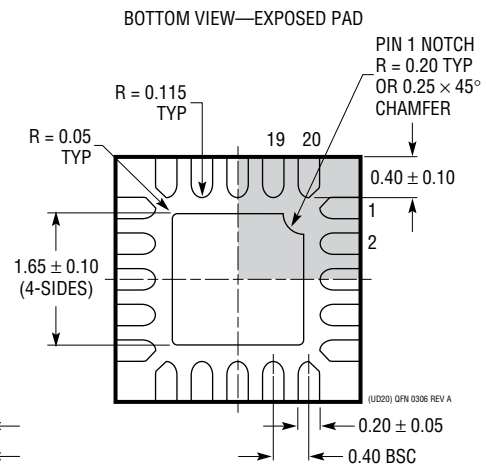
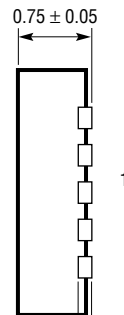
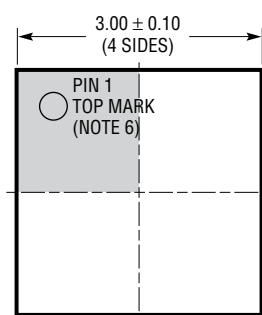

- NOTE:
1. DRAWING IS NOT A JEDEC PACKAGE OUTLINE
  2. DRAWING NOT TO SCALE
  3. ALL DIMENSIONS ARE IN MILLIMETERS
  4. DIMENSIONS OF EXPOSED PAD ON BOTTOM OF PACKAGE DO NOT INCLUDE MOLD FLASH. MOLD FLASH, IF PRESENT, SHALL NOT EXCEED 0.15mm ON ANY SIDE
  5. EXPOSED PAD SHALL BE SOLDER PLATED
  6. SHADED AREA IS ONLY A REFERENCE FOR PIN 1 LOCATION ON THE TOP AND BOTTOM OF PACKAGE

## TYPICAL APPLICATION

### 3-LED Main and One LED Sub at 20mA Full Scale

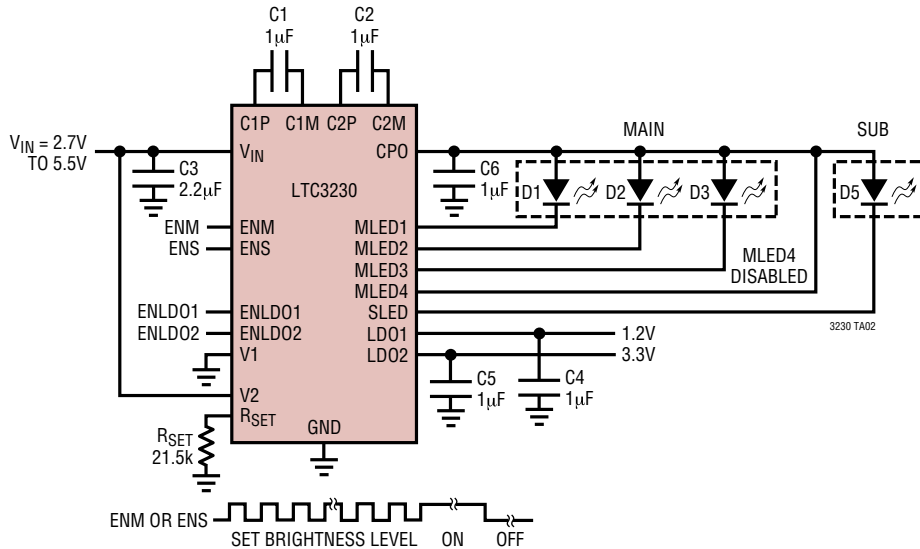

## RELATED PARTS

PART NUMBER	DESCRIPTION	COMMENTS
LT <sup>®</sup> 3023	Dual 100mA, Low Noise Micropower, LDO	Dual Low Noise < 20µV <sub>RMS</sub> , Stable with 1µF Ceramic Capacitors, V <sub>IN</sub> : 1.8V to 20V, V <sub>OUT(MIN)</sub> = 1.22V, Dropout Voltage = 0.3V, I <sub>Q</sub> = 40µA, I <sub>SD</sub> < 1µA, V <sub>OUT</sub> = Adj., MS10, DFN Packages
LT3024	Dual 100mA/500mA, Low Noise Micropower, LDO	Dual Low Noise < 20µV <sub>RMS</sub> , Stable with 1µF/3.3µF Ceramic Capacitors, V <sub>IN</sub> : 1.8V to 20V, V <sub>OUT(MIN)</sub> = 1.22V, Dropout Voltage = 0.3V, I <sub>Q</sub> = 60µA, I <sub>SD</sub> < 1µA, V <sub>OUT</sub> = Adj., TSSOP16, DFN Packages
LT3028	Dual 100mA/500mA, Low Noise Micropower, LDO with Independent Inputs	Dual Low Noise < 20µV <sub>RMS</sub> , Stable with 1µF/3.3µF Ceramic Capacitors, V <sub>IN</sub> : 1.8V to 20V, V <sub>OUT(MIN)</sub> = 1.22V, Dropout Voltage = 0.3V/3.3µF, I <sub>Q</sub> = 60µA/65µA, I <sub>SD</sub> < 1µA, V <sub>OUT</sub> = Adj., TSSOP16, DFN Packages
LTC3207	600mA Universal Multi-Output LED/CAM Driver	V <sub>BAT</sub> : 2.9V to 5.5V, 12 Universal Individually Controlled LED Drivers, One Camera Driver, 4mm × 4mm QFN Package
LTC3208	High Current Software Configurable Multidisplay LED Controller	95% Efficiency, V <sub>IN</sub> : 2.9V to 4.5V, 1A Output Current; Up to 17 LEDs for 5 Displays, 5mm × 5mm QFN Package
LTC3209	600mA MAIN/Camera LED Controller	Up to 8 LEDs, 94% Efficiency, V <sub>IN</sub> : 2.9V to 4.5V, 1x/1.5x/2x Boost Modes, 4mm × 4mm QFN Package
LTC3210/ LTC3210-1/ LTC3210-2/ LTC3210-3	500mA MAIN/Camera LED Controller	Up to 5 LEDs, 95% Efficiency, V <sub>IN</sub> : 2.9V to 4.5V, 1x/1.5x/2x Boost Modes, Exponential Brightness Control, “-1” Version Has 64-Step Linear Brightness Control, 3mm × 3mm QFN Package, “-2” Version Drives 4 Main LEDs, “-3” Drives 3 Main LEDs
LTC3219	250mA Universal 9-Channel LED Driver	91% Efficiency, V <sub>IN</sub> : 2.9V to 5.5V, Up to 9 × 28mA LEDs, Universal LED Programmability, 3mm × 3mm QFN20 Package