

## FEATURES

- **High Sampling Rates: 1MHz (LTC1196)  
750kHz (LTC1198)**
- **Low Cost**
- Single Supply 3V and 5V Specifications
- Low Power: 10mW at 3V Supply  
50mW at 5V Supply
- Auto-Shutdown: 1nA Typical (LTC1198)
- $\pm 1/2$ LSB Total Unadjusted Error over Temperature
- 3-Wire Serial I/O
- 1V to 5V Input Span Range (LTC1196)
- Converts 1MHz Inputs to 7 Effective Bits
- Differential Inputs (LTC1196)
- 2-Channel MUX (LTC1198)
- SO-8 Plastic Package

## APPLICATIONS

- High Speed Data Acquisition
- Disk Drives
- Portable or Compact Instrumentation
- Low Power or Battery-Operated Systems

## DESCRIPTION

The LTC<sup>®</sup>1196/LTC1198 are 600ns, 8-bit A/D converters with sampling rates up to 1MHz. They are offered in 8-pin SO packages and operate on 3V to 6V supplies. Power dissipation is only 10mW with a 3V supply or 50mW with a 5V supply. The LTC1198 automatically powers down to a typical supply current of 1nA whenever it is not performing conversions. These 8-bit switched-capacitor successive approximation ADCs include sample-and-holds. The LTC1196 has a differential analog input; the LTC1198 offers a software selectable 2-channel MUX.

The 3-wire serial I/O, SO-8 packages, 3V operation and extremely high sample rate-to-power ratio make these ADCs an ideal choice for compact, high speed systems.

These ADCs can be used in ratiometric applications or with external references. The high impedance analog inputs and the ability to operate with reduced spans below 1V full scale (LTC1196) allow direct connection to signal sources in many applications, eliminating the need for gain stages.

The A grade devices are specified with total unadjusted error of  $\pm 1/2$ LSB maximum over temperature.

LT, LT, LTC and LTM are registered trademarks of Linear Technology Corporation. All other trademarks are the property of their respective owners.

## TYPICAL APPLICATION

Single 5V Supply, 1MSPS, 8-Bit Sampling ADC

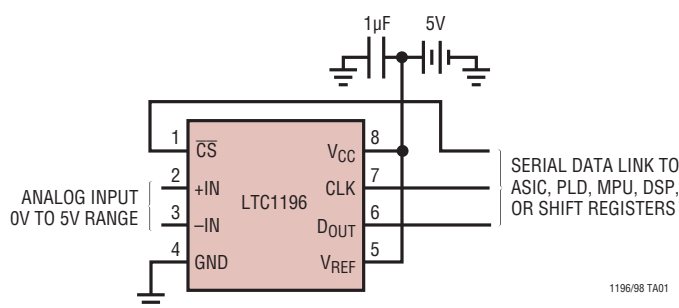

Effective Bits and S/(N + D) vs Input Frequency

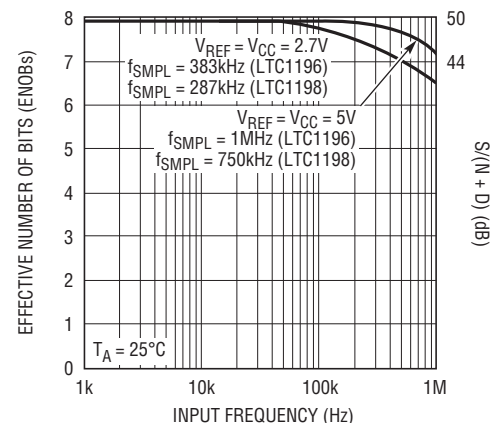

# LTC1196/LTC1198

## ABSOLUTE MAXIMUM RATINGS (Notes 1, 2)

Supply Voltage ( $V_{CC}$ ) to GND .....	7V	Operating Temperature Range	LTC1196-1AC, LTC1198-1AC, LTC1196-1BC, LTC1198-1BC, LTC1196-2AC, LTC1198-2AC, LTC1196-2BC, LTC1198-2BC .....	0°C to 70°C
Voltage		Storage Temperature Range.....		-65°C to 150°C
Analog Reference .....	-0.3V to $V_{CC} + 0.3V$	Lead Temperature (Soldering, 10 sec) .....		300°C
Digital Inputs .....	-0.3V to 7V			
Digital Outputs .....	-0.3V to $V_{CC} + 0.3V$			
Power Dissipation .....	500mW			

## PIN CONFIGURATION

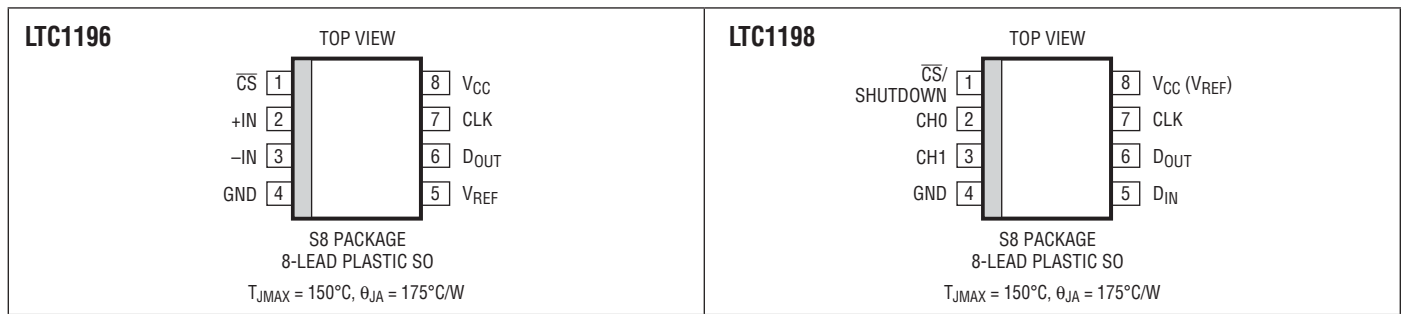

## ORDER INFORMATION

LEAD FREE FINISH	TAPE AND REEL	PART MARKING	PACKAGE DESCRIPTION	TEMPERATURE RANGE
LTC1196-1ACS8#PBF	LTC1196-1ACS8#TRPBF	11961A	8-Lead Plastic SO	0°C to 70°C
LTC1196-1BCS8#PBF	LTC1196-1BCS8#TRPBF	11961B	8-Lead Plastic SO	0°C to 70°C
LTC1196-2ACS8#PBF	LTC1196-2ACS8#TRPBF	11962A	8-Lead Plastic SO	0°C to 70°C
LTC1196-2BCS8#PBF	LTC1196-2BCS8#TRPBF	11962B	8-Lead Plastic SO	0°C to 70°C
LTC1198-1ACS8#PBF	LTC1198-1ACS8#TRPBF	11981A	8-Lead Plastic SO	0°C to 70°C
LTC1198-1BCS8#PBF	LTC1198-1BCS8#TRPBF	11981B	8-Lead Plastic SO	0°C to 70°C
LTC1198-2ACS8#PBF	LTC1198-2ACS8#TRPBF	11982A	8-Lead Plastic SO	0°C to 70°C
LTC1198-2BCS8#PBF	LTC1198-2BCS8#TRPBF	11982B	8-Lead Plastic SO	0°C to 70°C

Consult LTC Marketing for parts specified with wider operating temperature ranges.

Consult LTC Marketing for information on non-standard lead based finish parts.

For more information on lead free part marking, go to: <http://www.linear.com/leadfree/>

For more information on tape and reel specifications, go to: <http://www.linear.com/tapeandreeel/>

## RECOMMENDED OPERATING CONDITIONS

The ● denotes the specifications which apply over the full operating temperature range, otherwise specifications are at  $T_A = 25^\circ\text{C}$ .

SYMBOL	PARAMETER	CONDITIONS	LTC1196-1 LTC1198-1			LTC1196-2 LTC1198-2			UNITS
			MIN	TYP	MAX	MIN	TYP	MAX	
$V_{CC}$	Supply Voltage		2.7		6	2.7		6	V
<b><math>V_{CC} = 5\text{V}</math> Operation</b>									
$f_{CLK}$	Clock Frequency		● 0.01 0.01		14.4 12.0	0.01 0.01		12.0 9.6	MHz MHz
$t_{CYC}$	Total Cycle Time	LTC1196 LTC1198	12 16			12 16			CLK CLK
$t_{SMPL}$	Analog Input Sampling Time		2.5			2.5			CLK
$t_{h\overline{CS}}$	Hold Time $\overline{CS}$ Low After Last CLK $\uparrow$		10			13			ns
$t_{su\overline{CS}}$	Setup Time $\overline{CS}\downarrow$ Before First CLK $\uparrow$ (See Figures 1, 2)		20			26			ns
$t_{hDI}$	Hold Time $D_{IN}$ After CLK $\uparrow$	LTC1198	20			26			ns
$t_{suDI}$	Setup Time $D_{IN}$ Stable Before CLK $\uparrow$	LTC1198	20			26			ns
$t_{WHCLK}$	CLK High Time	$f_{CLK} = f_{CLK(MAX)}$	40%			40%			$1/f_{CLK}$
$t_{WLCLK}$	CLK Low Time	$f_{CLK} = f_{CLK(MAX)}$	40%			40%			$1/f_{CLK}$
$t_{WH\overline{CS}}$	$\overline{CS}$ High Time Between Data Transfer Cycles		25			32			ns
$t_{WL\overline{CS}}$	$\overline{CS}$ Low Time During Data Transfer	LTC1196 LTC1198	11 15			11 15			CLK CLK

## CONVERTER AND MULTIPLEXER CHARACTERISTICS

The ● denotes the specifications which apply over the full operating temperature range, otherwise specifications are at  $T_A = 25^\circ\text{C}$ .  $V_{CC} = 5\text{V}$ ,  $V_{REF} = 5\text{V}$ ,  $f_{CLK} = f_{CLK(MAX)}$  as defined in Recommended Operating Conditions, unless otherwise noted.

PARAMETER	CONDITIONS	LTC1196-1 LTC1198-1			LTC1196-2 LTC1198-2			UNITS
		MIN	TYP	MAX	MIN	TYP	MAX	
No Missing Codes Resolution		● 8			8			Bits
Offset Error		●		$\pm 1/2$			$\pm 1$	LSB
Linearity Error	(Note 3)	●		$\pm 1/2$			$\pm 1$	LSB
Full-Scale Error		●		$\pm 1/2$			$\pm 1$	LSB
Total Unadjusted Error (Note 4)	LTC1196, $V_{REF} = 5.000\text{V}$ LTC1198, $V_{CC} = 5.000\text{V}$	●		$\pm 1/2$			$\pm 1$	LSB
Analog and REF Input Range	LTC1196			-0.05V to $V_{CC} + 0.05\text{V}$				V
Analog Input Leakage Current	(Note 5)	●		$\pm 1$			$\pm 1$	$\mu\text{A}$

## DIGITAL AND DC ELECTRICAL CHARACTERISTICS

The ● denotes the specifications which apply over the full operating temperature range, otherwise specifications are at  $T_A = 25^\circ\text{C}$ .  $V_{CC} = 5\text{V}$ ,  $V_{REF} = 5\text{V}$ , unless otherwise noted.

SYMBOL	PARAMETER	CONDITIONS	MIN	TYP	MAX	UNITS
$V_{IH}$	High Level Input Voltage	$V_{CC} = 5.25\text{V}$	● 2.0			V
$V_{IL}$	Low Level Input Voltage	$V_{CC} = 4.75\text{V}$	●		0.8	V
$I_{IH}$	High Level Input Current	$V_{IN} = V_{CC}$	●		2.5	$\mu\text{A}$
$I_{IL}$	Low Level Input Current	$V_{IN} = 0\text{V}$	●		-2.5	$\mu\text{A}$
$V_{OH}$	High Level Output Voltage	$V_{CC} = 4.75\text{V}$ , $I_O = 10\mu\text{A}$ $V_{CC} = 4.75\text{V}$ , $I_O = 360\mu\text{A}$	● 4.5 ● 2.4	4.74 4.71		V V

## DIGITAL AND DC ELECTRICAL CHARACTERISTICS

The ● denotes the specifications which apply over the full operating temperature range, otherwise specifications are at  $T_A = 25^\circ\text{C}$ .  $V_{CC} = 5\text{V}$ ,  $V_{REF} = 5\text{V}$ , unless otherwise noted.

SYMBOL	PARAMETER	CONDITIONS	MIN	TYP	MAX	UNITS
$V_{OL}$	Low Level Output Voltage	$V_{CC} = 4.75\text{V}$ , $I_O = 1.6\text{mA}$	●		0.4	V
$I_{OZ}$	Hi-Z Output Leakage	$\overline{CS} = \text{High}$	●		$\pm 3$	$\mu\text{A}$
$I_{SOURCE}$	Output Source Current	$V_{OUT} = 0\text{V}$		-25		$\text{mA}$
$I_{SINK}$	Output Sink Current	$V_{OUT} = V_{CC}$		45		$\text{mA}$
$I_{REF}$	Reference Current, LTC1196	$\overline{CS} = V_{CC}$ $f_{SMPL} = f_{SMPL(MAX)}$	●	0.001	3	$\mu\text{A}$
			●	0.5	1	$\text{mA}$
$I_{CC}$	Supply Current	$\overline{CS} = V_{CC}$ , LTC1198 (Shutdown) $\overline{CS} = V_{CC}$ , LTC1196 $f_{SMPL} = f_{SMPL(MAX)}$ , LTC1196/LTC1198	●	0.001	3	$\mu\text{A}$
			●	7	15	$\text{mA}$
			●	11	20	$\text{mA}$

## DYNAMIC ACCURACY

The ● denotes the specifications which apply over the full operating temperature range, otherwise specifications are at  $T_A = 25^\circ\text{C}$ .  $V_{CC} = 5\text{V}$ ,  $V_{REF} = 5\text{V}$ ,  $f_{CLK} = f_{CLK(MAX)}$  as defined in Recommended Operating Conditions, unless otherwise noted.

SYMBOL	PARAMETER	CONDITIONS	LTC1196			LTC1198			UNITS
			MIN	TYP	MAX	MIN	TYP	MAX	
S/(N + D)	Signal-to-Noise Plus Distortion	500kHz/1MHz Input Signal		47/45			47/45		dB
THD	Total Harmonic Distortion	500kHz/1MHz Input Signal		49/47			49/47		dB
	Peak Harmonic or Spurious Noise	500kHz/1MHz Input Signal		55/48			55/48		dB
IMD	Intermodulation Distortion	$f_{IN1} = 499.37\text{kHz}$ $f_{IN2} = 502.446\text{kHz}$		51			51		dB
	Full-Power Bandwidth			8			8		MHz
	Full Linear Bandwidth [S/(N + D) > 44dB]			1			1		MHz

## AC CHARACTERISTICS

The ● denotes the specifications which apply over the full operating temperature range, otherwise specifications are at  $T_A = 25^\circ\text{C}$ .  $V_{CC} = 5\text{V}$ ,  $V_{REF} = 5\text{V}$ ,  $f_{CLK} = f_{CLK(MAX)}$  as defined in Recommended Operating Conditions, unless otherwise noted.

SYMBOL	PARAMETER	CONDITIONS	LTC1196-1 LTC1198-1			LTC1196-2 LTC1198-2			UNITS
			MIN	TYP	MAX	MIN	TYP	MAX	
$t_{CONV}$	Conversion Time (See Figures 1, 2)				600			710	ns
			●		710			900	ns
$f_{SMPL(MAX)}$	Maximum Sampling Frequency	LTC1196	●	1.20		1.00			MHz
		LTC1196	●	1.00		0.80			MHz
		LTC1198	●	0.90		0.75			MHz
		LTC1198	●	0.75		0.60			MHz
$t_{dDO}$	Delay Time, $\text{CLK}\uparrow$ to $D_{OUT}$ Data Valid	$C_{LOAD} = 20\text{pF}$		55	64		68	78	ns
			●		73		94	ns	
$t_{DIS}$	Delay Time $\overline{CS}\uparrow$ to $D_{OUT}$ Hi-Z		●	70	120		88	150	ns
$t_{en}$	Delay Time, $\text{CLK}\downarrow$ to $D_{OUT}$ Enabled	$C_{LOAD} = 20\text{pF}$	●	30	50		43	63	ns
$t_{hDO}$	Time Output Data Remains Valid After $\text{CLK}\uparrow$	$C_{LOAD} = 20\text{pF}$	●	30	45		30	55	ns
$t_f$	$D_{OUT}$ Fall Time	$C_{LOAD} = 20\text{pF}$	●	5	15		10	20	ns
$t_r$	$D_{OUT}$ Rise	$C_{LOAD} = 20\text{pF}$	●	5	15		10	20	ns
$C_{IN}$	Input Capacitance	Analog Input On Channel		30			30		pF
		Analog Input Off Channel		5			5		pF
		Digital Input		5			5		pF

## RECOMMENDED OPERATING CONDITIONS

The ● denotes the specifications which apply over the full operating temperature range, otherwise specifications are at  $T_A = 25^\circ\text{C}$ .  $V_{CC} = 2.7\text{V}$  Operation.

SYMBOL	PARAMETER	CONDITIONS	LTC1196-1 LTC1198-1			LTC1196-2 LTC1198-2			UNITS
			MIN	TYP	MAX	MIN	TYP	MAX	
$f_{\text{CLK}}$	Clock Frequency		● 0.01 0.01		5.4 4.6	0.01 0.01		4 3	MHz MHz
$t_{\text{CYC}}$	Total Cycle Time	LTC1196 LTC1198		12 16		12 16			CLK CLK
$t_{\text{SMPL}}$	Analog Input Sampling Time			2.5		2.5			CLK
$t_{\text{h}\overline{\text{CS}}}$	Hold Time $\overline{\text{CS}}$ Low After Last CLK $\uparrow$			20		40			ns
$t_{\text{su}\overline{\text{CS}}}$	Setup Time $\overline{\text{CS}}\downarrow$ Before First CLK $\uparrow$ (See Figures 1, 2)			40		78			ns
$t_{\text{hDI}}$	Hold Time $D_{\text{IN}}$ After CLK $\uparrow$	LTC1198		40		78			ns
$t_{\text{suDI}}$	Setup Time $D_{\text{IN}}$ Stable Before CLK $\uparrow$	LTC1198		40		78			ns
$t_{\text{WHCLK}}$	CLK High Time	$f_{\text{CLK}} = f_{\text{CLK}(\text{MAX})}$		40%		40%			$1/f_{\text{CLK}}$
$t_{\text{WLCLK}}$	CLK Low Time	$f_{\text{CLK}} = f_{\text{CLK}(\text{MAX})}$		40%		40%			$1/f_{\text{CLK}}$
$t_{\text{WH}\overline{\text{CS}}}$	$\overline{\text{CS}}$ High Time Between Data Transfer Cycles			50		96			ns
$t_{\text{WL}\overline{\text{CS}}}$	$\overline{\text{CS}}$ Low Time During Data Transfer	LTC1196 LTC1198		11 15		11 15			CLK CLK

## CONVERTER AND MULTIPLEXER CHARACTERISTICS

The ● denotes the specifications which apply over the full operating temperature range, otherwise specifications are at  $T_A = 25^\circ\text{C}$ .  $V_{CC} = 2.7\text{V}$ ,  $V_{\text{REF}} = 2.5\text{V}$ ,  $f_{\text{CLK}} = f_{\text{CLK}(\text{MAX})}$  as defined in Recommended Operating Conditions, unless otherwise noted.

PARAMETER	CONDITIONS	LTC1196-1 LTC1198-1			LTC1196-2 LTC1198-2			UNITS
		MIN	TYP	MAX	MIN	TYP	MAX	
No Missing Codes Resolution		● 8			8			Bits
Offset Error		●		$\pm 1/2$			$\pm 1$	LSB
Linearity Error	(Note 3)	●		$\pm 1/2$			$\pm 1$	LSB
Full-Scale Error		●		$\pm 1/2$			$\pm 1$	LSB
Total Unadjusted Error (Note 4)	LTC1196, $V_{\text{REF}} = 2.5.000\text{V}$ LTC1198, $V_{CC} = 2.700\text{V}$	●		$\pm 1/2$			$\pm 1$	LSB
Analog and REF Input Range	LTC1196			-0.05V to $V_{CC} + 0.05\text{V}$				V
Analog Input Leakage Current	(Note 5)	●		$\pm 1$			$\pm 1$	$\mu\text{A}$

## DIGITAL AND DC ELECTRICAL CHARACTERISTICS

The ● denotes the specifications which apply over the full operating temperature range, otherwise specifications are at  $T_A = 25^\circ\text{C}$ .  $V_{CC} = 2.7\text{V}$ ,  $V_{\text{REF}} = 2.5\text{V}$ , unless otherwise noted.

SYMBOL	PARAMETER	CONDITIONS	MIN	TYP	MAX	UNITS
$V_{\text{IH}}$	High Level Input Voltage	$V_{CC} = 3.6\text{V}$	● 1.9			V
$V_{\text{IL}}$	Low Level Input Voltage	$V_{CC} = 2.7\text{V}$	●		0.45	V
$I_{\text{IH}}$	High Level Input Current	$V_{\text{IN}} = V_{CC}$	●		2.5	$\mu\text{A}$
$I_{\text{IL}}$	Low Level Input Current	$V_{\text{IN}} = 0\text{V}$	●		-2.5	$\mu\text{A}$
$V_{\text{OH}}$	High Level Output Voltage	$V_{CC} = 2.7\text{V}$ , $I_O = 10\mu\text{A}$ $V_{CC} = 2.7\text{V}$ , $I_O = 360\mu\text{A}$	● 2.3 ● 2.1	2.60 2.45		V V
$V_{\text{OL}}$	Low Level Output Voltage	$V_{CC} = 2.7\text{V}$ , $I_O = 400\mu\text{A}$	●		0.3	V
$I_{\text{OZ}}$	Hi-Z Output Leakage	$\overline{\text{CS}} = \text{High}$	●		$\pm 3$	$\mu\text{A}$

## DIGITAL AND DC ELECTRICAL CHARACTERISTICS

The ● denotes the specifications which apply over the full operating temperature range, otherwise specifications are at  $T_A = 25^\circ\text{C}$ .  $V_{CC} = 2.7\text{V}$ ,  $V_{REF} = 2.5\text{V}$ , unless otherwise noted.

SYMBOL	PARAMETER	CONDITIONS	MIN	TYP	MAX	UNITS
$I_{SOURCE}$	Output Source Current	$V_{OUT} = 0\text{V}$		-10		mA
$I_{SINK}$	Output Sink Current	$V_{OUT} = V_{CC}$		15		mA
$I_{REF}$	Reference Current, LTC1196	$\overline{CS} = V_{CC}$ $f_{SMPL} = f_{SMPL(MAX)}$	●	0.001	3.0	$\mu\text{A}$
			●	0.25	0.5	mA
$I_{CC}$	Supply Current	$\overline{CS} = V_{CC} = 3.3\text{V}$ , LTC1198 (Shutdown) $\overline{CS} = V_{CC} = 3.3\text{V}$ , LTC1196 $f_{SMPL} = f_{SMPL(MAX)}$ , LTC1196/LTC1198	●	0.001	3.0	$\mu\text{A}$
			●	1.5	4.5	mA
			●	2.0	6.0	mA

## DYNAMIC ACCURACY

The ● denotes the specifications which apply over the full operating temperature range, otherwise specifications are at  $T_A = 25^\circ\text{C}$ .  $V_{CC} = 2.7\text{V}$ ,  $V_{REF} = 2.5\text{V}$ ,  $f_{CLK} = f_{CLK(MAX)}$  as defined in Recommended Operating Conditions, unless otherwise noted.

SYMBOL	PARAMETER	CONDITIONS	LTC1196			LTC1198			UNITS
			MIN	TYP	MAX	MIN	TYP	MAX	
S/(N + D)	Signal-to-Noise Plus Distortion	190kHz/380kHz Input Signal		47/45			47/45		dB
THD	Total Harmonic Distortion	190kHz/380kHz Input Signal		49/47			49/47		dB
	Peak Harmonic or Spurious Noise	190kHz/380kHz Input Signal		53/46			55/46		dB
IMD	Intermodulation Distortion	$f_{IN1} = 189.37\text{kHz}$ $f_{IN2} = 192.446\text{kHz}$		51			51		dB
	Full-Power Bandwidth			5			5		MHz
	Full Linear Bandwidth [S/(N + D) > 44dB]			0.5			0.5		MHz

## AC CHARACTERISTICS

The ● denotes the specifications which apply over the full operating temperature range, otherwise specifications are at  $T_A = 25^\circ\text{C}$ .  $V_{CC} = 2.7\text{V}$ ,  $V_{REF} = 2.5\text{V}$ ,  $f_{CLK} = f_{CLK(MAX)}$  as defined in Recommended Operating Conditions, unless otherwise noted.

SYMBOL	PARAMETER	CONDITIONS	LTC1196-1 LTC1198-1			LTC1196-2 LTC1198-2			UNITS
			MIN	TYP	MAX	MIN	TYP	MAX	
$t_{CONV}$	Conversion Time (See Figures 1, 2)				1.58 1.85			2.13 2.84	$\mu\text{s}$ $\mu\text{s}$
$f_{SMPL(MAX)}$	Maximum Sampling Frequency	LTC1196	●	450			333		kHz
		LTC1196	●	383			250		kHz
		LTC1198	●	337			250		kHz
		LTC1198	●	287			187		kHz
$t_{dDO}$	Delay Time, $\text{CLK}\uparrow$ to $D_{OUT}$ Data Valid	$C_{LOAD} = 20\text{pF}$		100	150 180		130	200 250	ns ns
$t_{DIS}$	Delay Time $\overline{CS}\uparrow$ to $D_{OUT}$ Hi-Z			110	220		120	250	ns
$t_{en}$	Delay Time, $\text{CLK}\downarrow$ to $D_{OUT}$ Enabled	$C_{LOAD} = 20\text{pF}$		80	130		100	200	ns
$t_{hDO}$	Time Output Data Remains Valid After $\text{CLK}\uparrow$	$C_{LOAD} = 20\text{pF}$		45	90		45	120	ns
$t_f$	$D_{OUT}$ Fall Time	$C_{LOAD} = 20\text{pF}$		10	30		15	40	ns
$t_r$	$D_{OUT}$ Rise	$C_{LOAD} = 20\text{pF}$		10	30		15	40	ns
$C_{IN}$	Input Capacitance	Analog Input On Channel		30			30		pF
		Analog Input Off Channel		5			5		pF
		Digital Input		5			5		pF

**Note 1:** Stresses beyond those listed under Absolute Maximum Ratings may cause permanent damage to the device. Exposure to any Absolute

Maximum Rating condition for extended periods may affect device reliability and lifetime.

## ELECTRICAL CHARACTERISTICS

**Note 2:** All voltage values are with respect to GND.

**Note 3:** Integral nonlinearity is defined as deviation of a code from a straight line passing through the actual endpoints of the transfer curve. The deviation is measured from the center of the quantization band.

**Note 4:** Total unadjusted error includes offset, full scale, linearity, multiplexer and hold step errors.

**Note 5:** Channel leakage current is measured after the channel selection.

## TYPICAL PERFORMANCE CHARACTERISTICS

Supply Current vs Clock Rate

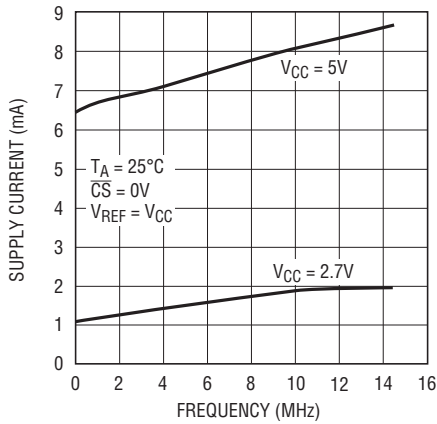

1196/98 G01

Supply Current vs Supply Voltage

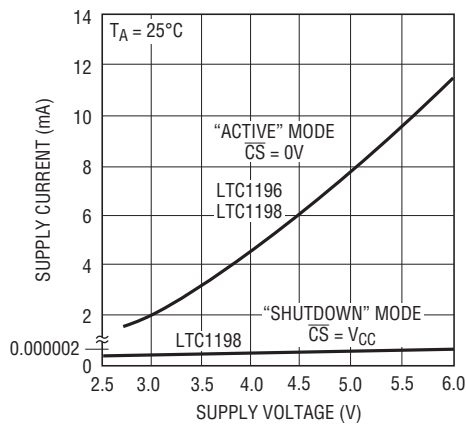

1196/98 G02

Supply Current vs Sample Rate

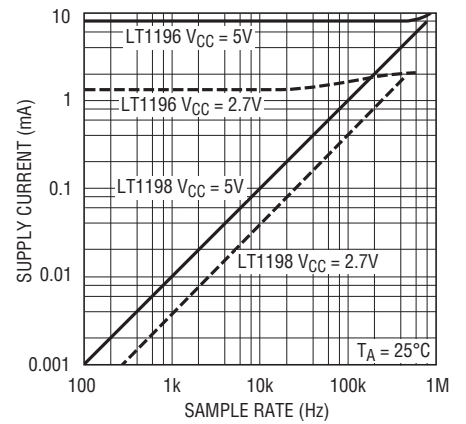

1196/98 G03

Supply Current vs Temperature

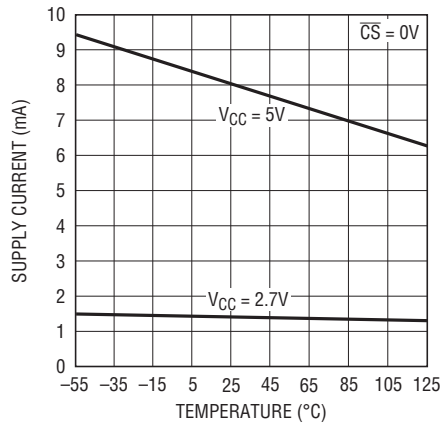

1196/98 G04

Offset vs Reference Voltage

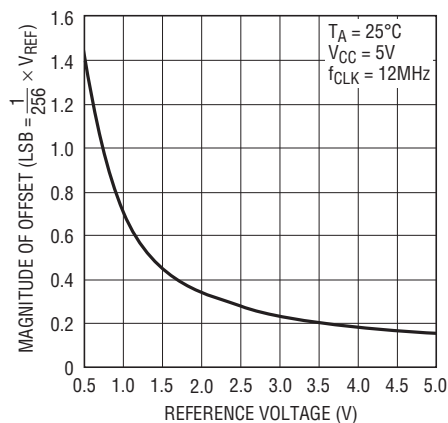

1196/98 G05

Offset vs Supply Voltage

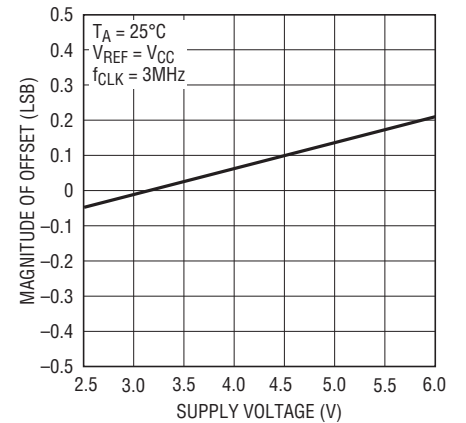

1196/98 G06

## TYPICAL PERFORMANCE CHARACTERISTICS

**Linearity Error vs Reference Voltage**

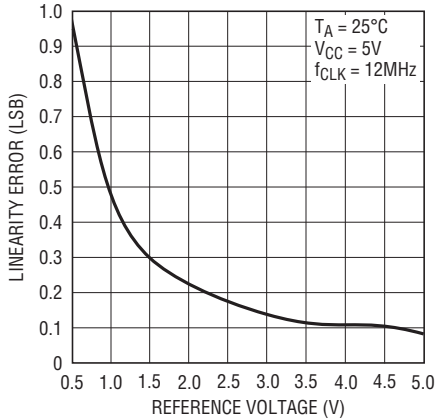

1196/98 G07

**Linearity Error vs Supply Voltage**

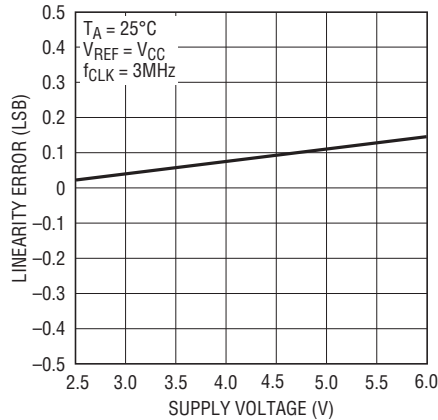

1196/98 G08

**Supply Current vs Sample Rate**

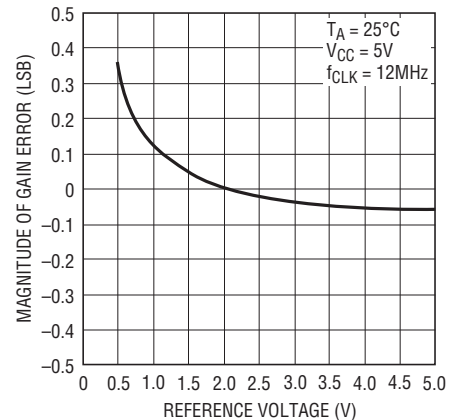

1196/98 G09

**Gain vs Supply Voltage**

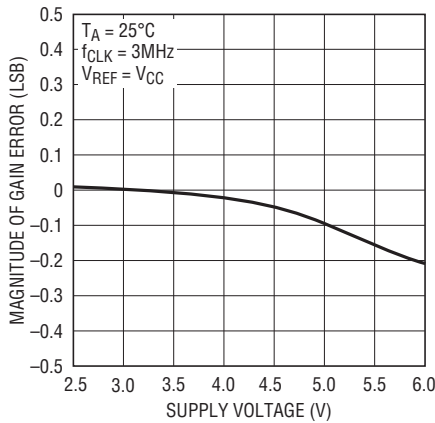

1196/98 G10

**Maximum Clock Frequency vs Supply Voltage**

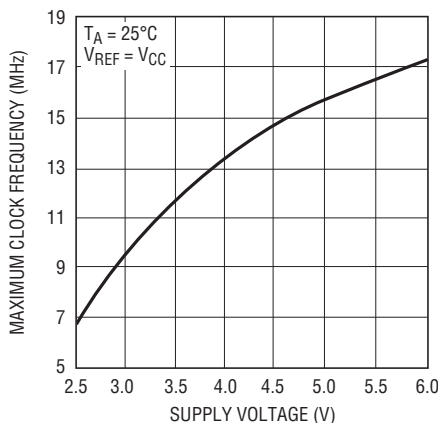

1196/98 G11

**Maximum Clock Frequency vs Source Resistance**

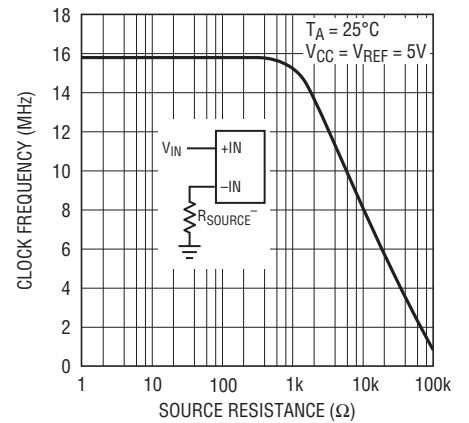

1196/98 G12

**Minimum Clock Rate for 0.1LSB\* Error**

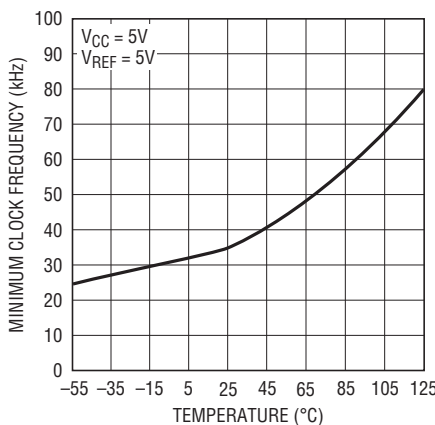

1196/98 G13

**ADC Noise vs Referenced and Supply Voltage**

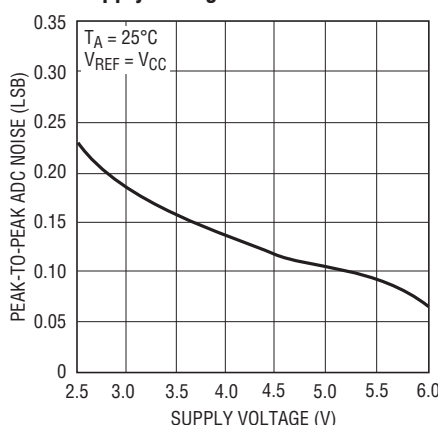

1196/98 G14

**Sample-and-Hold Acquisition Time vs Source Resistance**

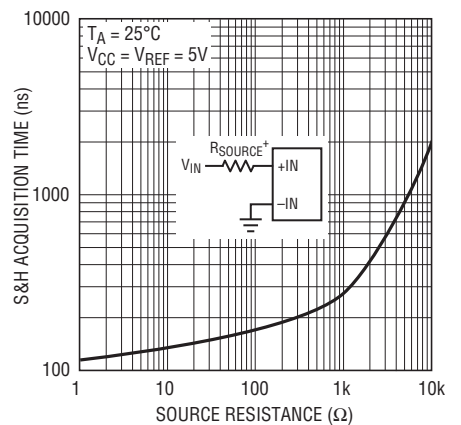

1196/98 G15

\*AS THE FREQUENCY IS DECREASED FROM 12MHz, MINIMUM CLOCK FREQUENCY ( $\Delta\text{ERROR} \leq 0.1\text{LSB}$ ) REPRESENTS THE FREQUENCY AT WHICH A 0.1LSB SHIFT IN ANY CODE TRANSITION FROM ITS 12MHz VALUE IS FIRST DETECTED.



# TYPICAL PERFORMANCE CHARACTERISTICS

**Digital Input Logic Threshold vs Supply Voltage**

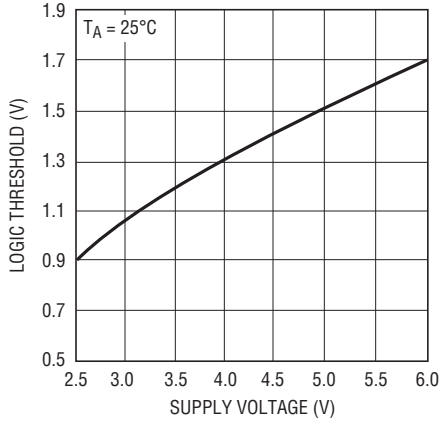

1196/98 G16

**D<sub>OUT</sub> Delay Time vs Supply Voltage**

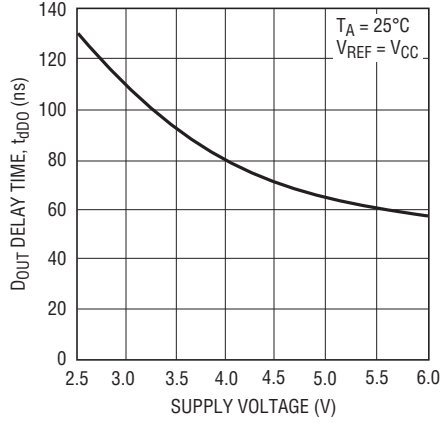

1196/98 G17

**D<sub>OUT</sub> Delay Time vs Temperature**

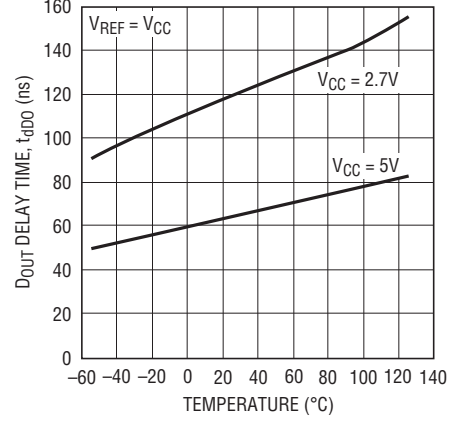

1196/98 G18

**Input Channel Leakage Current vs Temperature**

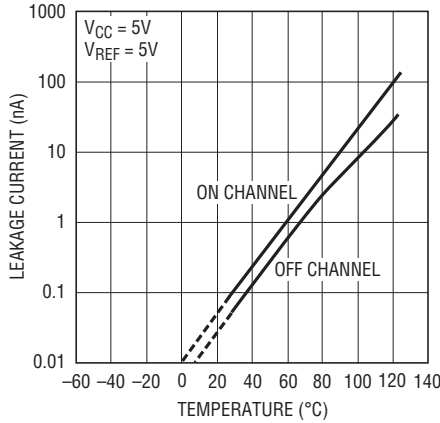

1196/98 G19

**Integral Nonlinearity vs Code at 5V**

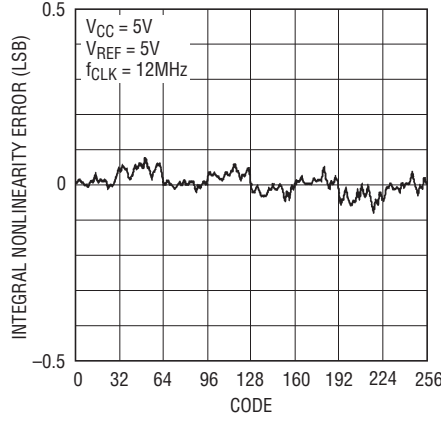

1196/98 G20

**Differential Nonlinearity vs Code at 5V**

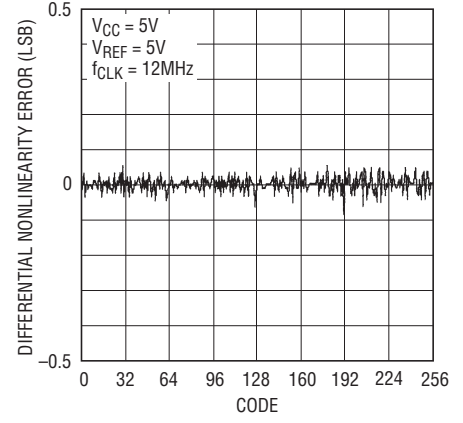

1196/98 G21

**Integral Nonlinearity vs Code at 2.7V**

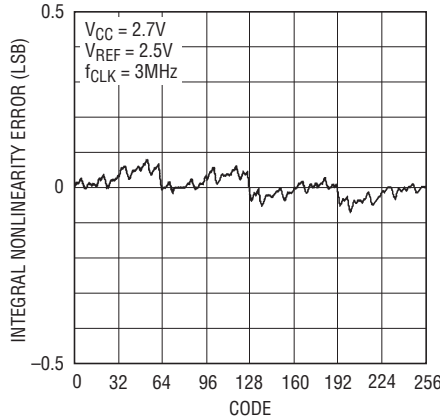

1196/98 G22

**Differential Nonlinearity vs Code at 2.7V**

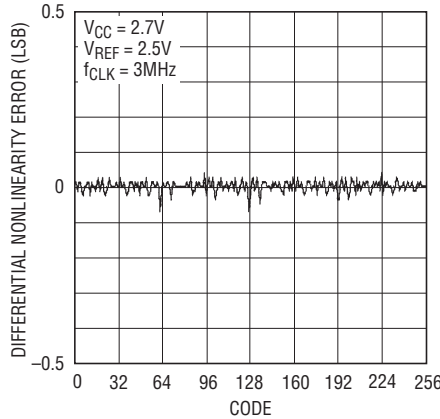

1196/98 G23

**Effective Bits and S/(N + D) vs Input Frequency**

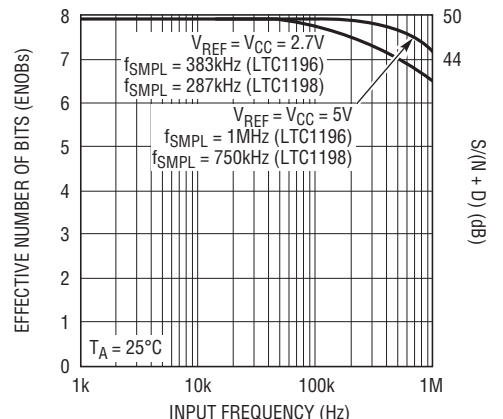

1196/98 G24

## TYPICAL PERFORMANCE CHARACTERISTICS

4096 Point FFT Plot at 5V

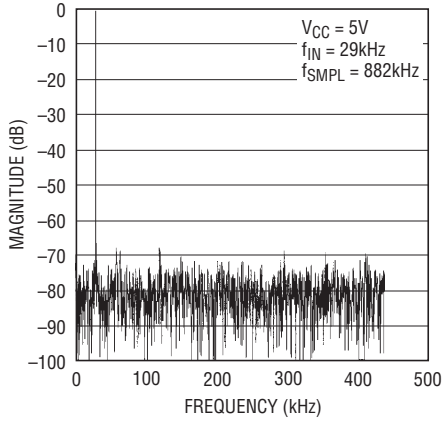

1196/98 G25

4096 Point FFT Plot at 2.7V

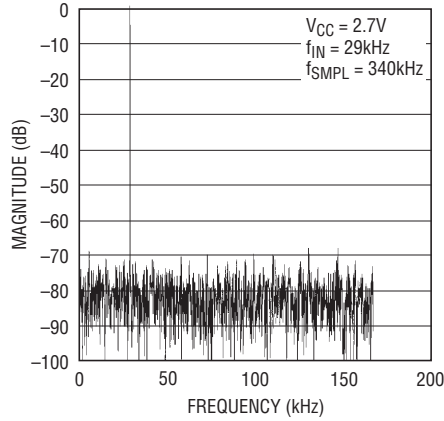

1196/98 G26

FFT Output of 455kHz AM Signal Digitized at 1Msps

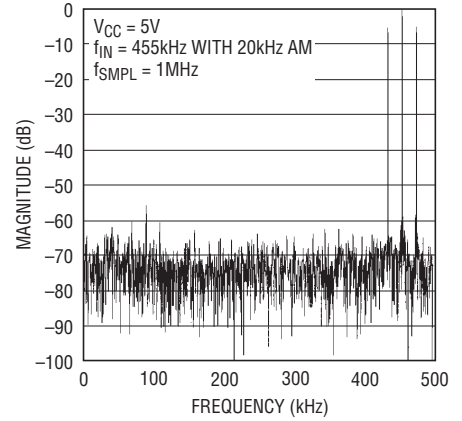

1196/98 G27

Power Supply Feedthrough vs Ripple Frequency

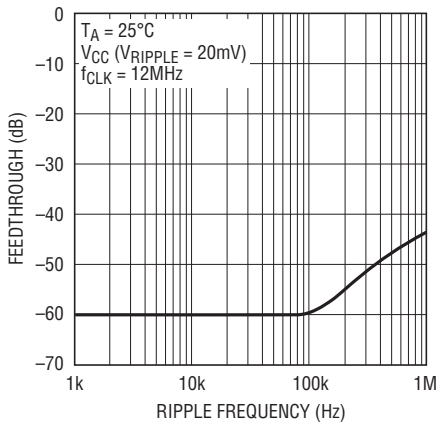

1196/98 G28

Power Supply Feedthrough vs Ripple Frequency

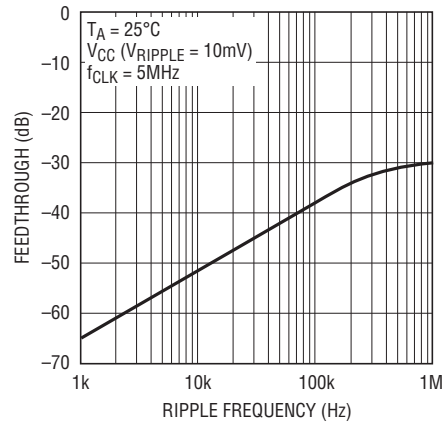

1196/98 G29

S/(N + D) vs Reference Voltage and Input Frequency

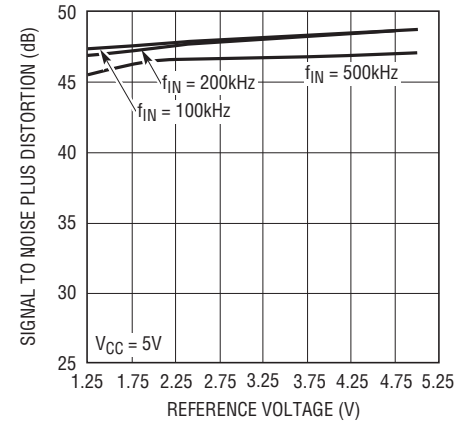

1196/98 G30

Intermodulation Distortion at 2.7V

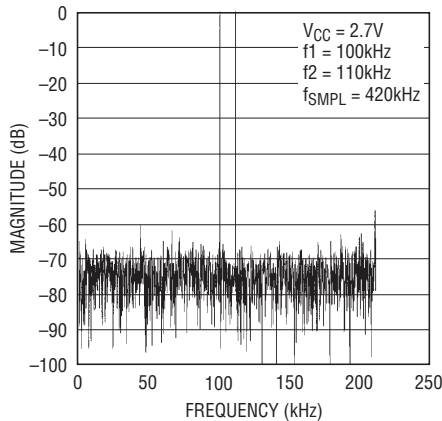

1196/98 G31

Intermodulation Distortion at 5V

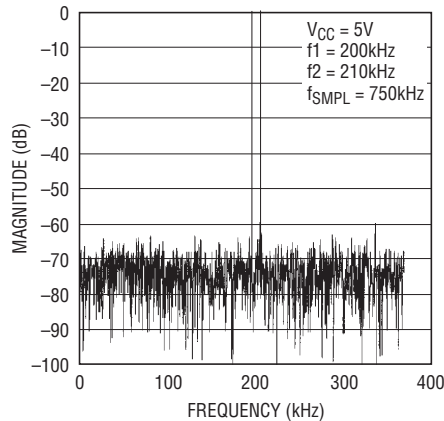

1196/98 G32

S/(N + D) vs Input Level

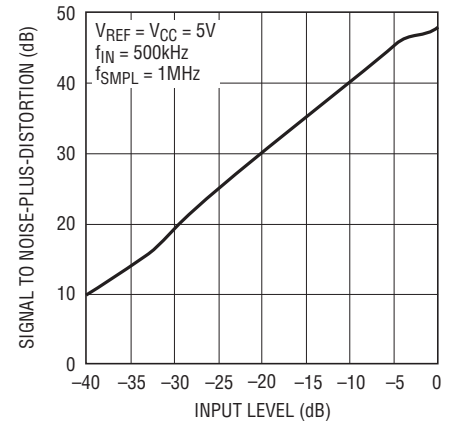

1196/98 G33

## TYPICAL PERFORMANCE CHARACTERISTICS

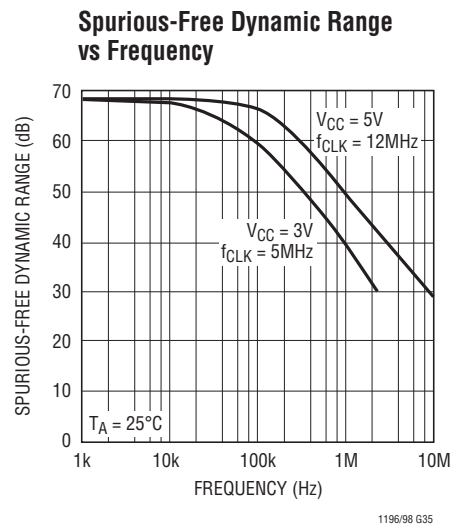
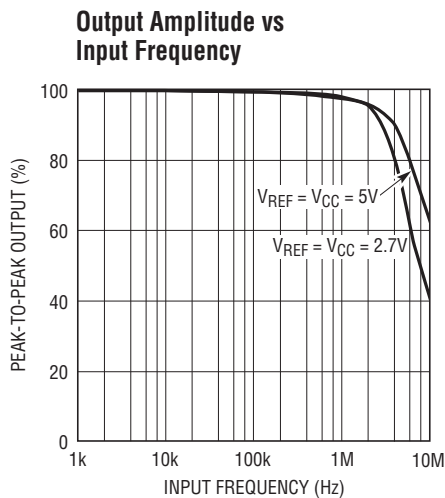

## PIN FUNCTIONS

### LTC1196

**$\overline{CS}$  (Pin 1):** Chip Select Input. A logic low on this input enables the LTC1196. A logic high on this input disables the LTC1196.

**$IN^+$  (Pin 2):** Analog Input. This input must be free of noise with respect to GND.

**$IN^-$  (Pin 3):** Analog Input. This input must be free of noise with respect to GND.

**GND (Pin 4):** Analog Ground. GND should be tied directly to an analog ground plane.

**$V_{REF}$  (Pin 5):** Reference Input. The reference input defines the span of the A/D converter and must be kept free of noise with respect to GND.

**$D_{OUT}$  (Pin 6):** Digital Data Output. The A/D conversion result is shifted out of this output.

**CLK (Pin 7):** Shift Clock. This clock synchronizes the serial data transfer.

**$V_{CC}$  (Pin 8):** Power Supply Voltage. This pin provides power to the A/D converter. It must be kept free of noise and ripple by bypassing directly to the analog ground plane.

### LTC1198

**$\overline{CS}/SHUTDOWN$  (Pin 1):** Chip Select Input. A logic low on this input enables the LTC1198. A logic high on this input disables the LTC1198 and disconnects the power to THE LTC1198.

**CHO (Pin 2):** Analog Input. This input must be free of noise with respect to GND.

**CH1 (Pin 3):** Analog Input. This input must be free of noise with respect to GND.

**GND (Pin 4):** Analog Ground. GND should be tied directly to an analog ground plane.

**$D_{IN}$  (Pin 5):** Digital Data Input. The multiplexer address is shifted into this input.

**$D_{OUT}$  (Pin 6):** Digital Data Output. The A/D conversion result is shifted out of this output.

**CLK (Pin 7):** Shift Clock. This clock synchronizes the serial data transfer.

**$V_{CC}$  ( $V_{REF}$ ) (Pin 8):** Power Supply and Reference Voltage. This pin provides power and defines the span of the A/D converter. It must be kept free of noise and ripple by bypassing directly to the analog ground plane.

## BLOCK DIAGRAM

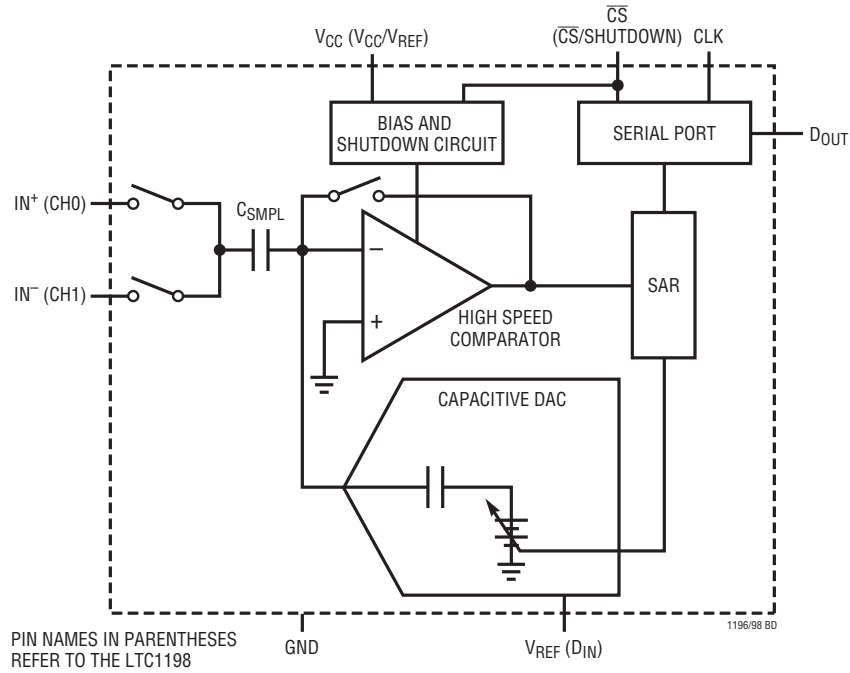

## TEST CIRCUITS

On and Off Channel Leakage Current

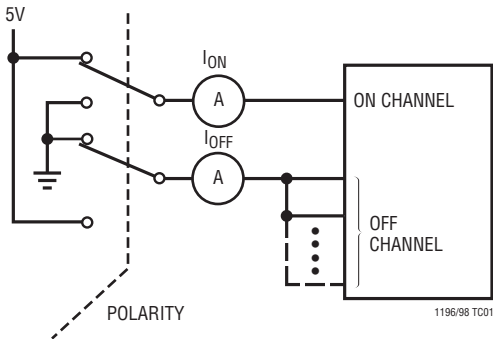

Load Circuit for  $t_{dDO}$ ,  $t_r$  and  $t_f$

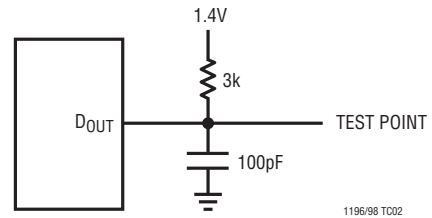

Voltage Waveform for  $D_{OUT}$  Rise and Fall Times,  $t_r$ ,  $t_f$

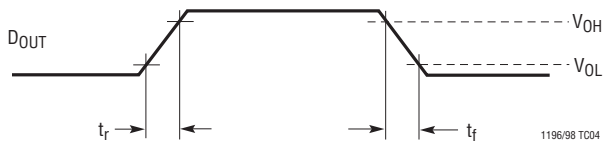

Voltage Waveform for  $D_{OUT}$  Delay Time,  $t_{dDO}$ ,  $t_{hDO}$

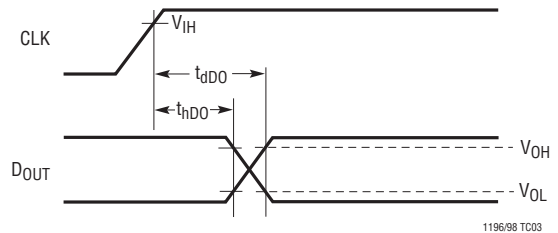

# TEST CIRCUITS

Load Circuit for  $t_{dis}$  and  $t_{en}$

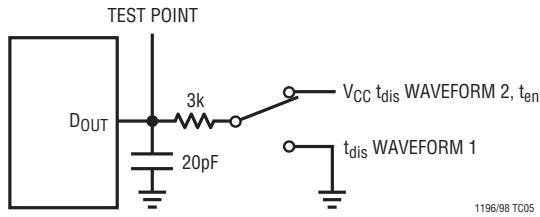

1196/98 TC05

Voltage Waveforms for  $t_{dis}$

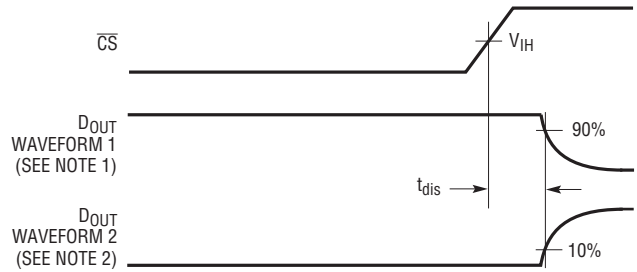

NOTE 1: WAVEFORM 1 IS FOR AN OUTPUT WITH INTERNAL CONDITIONS SUCH THAT THE OUTPUT IS HIGH UNLESS DISABLED BY THE OUTPUT CONTROL.  
 NOTE 2: WAVEFORM 2 IS FOR AN OUTPUT WITH INTERNAL CONDITIONS SUCH THAT THE OUTPUT IS LOW UNLESS DISABLED BY THE OUTPUT CONTROL.

1196/98 TC06

Voltage Waveforms for  $t_{en}$

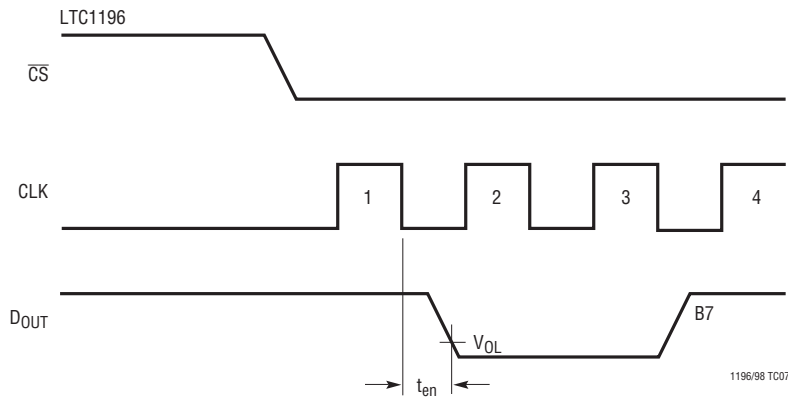

1196/98 TC07

Voltage Waveforms for  $t_{en}$

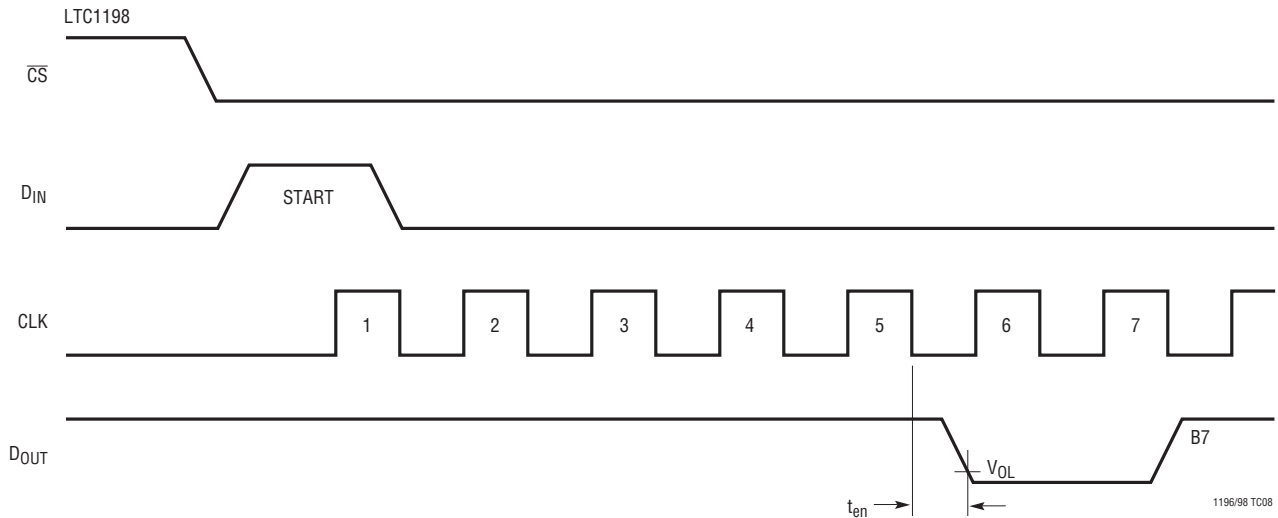

1196/98 TC08

## APPLICATIONS INFORMATION

### OVERVIEW

The LTC1196/LTC1198 are 600ns sampling 8-bit A/D converters packaged in tiny 8-pin SO packages and operating on 3V to 6V supplies. The ADCs draw only 10mW from a 3V supply or 50mW from a 5V supply.

Both the LTC1196 and the LTC1198 contain an 8-bit, switched-capacitor ADC, a sample-and-hold, and a serial port (see Block Diagram). The on-chip sample-and-holds have full-accuracy input bandwidths of 1MHz. Although they share the same basic design, the LTC1196 and LTC1198 differ in some respects. The LTC1196 has a differential input and has an external reference input pin. It can measure signals floating on a DC common mode voltage and can operate with reduced spans below 1V. The LTC1198 has a 2-channel input multiplexer and can convert either channel

with respect to ground or the difference between the two. It also automatically powers down when not performing conversion, drawing only leakage current.

### SERIAL INTERFACE

The LTC1196/LTC1198 will interface via three or four wires to ASICs, PLDs, microprocessors, DSPs, or shift registers (see Operating Sequence in Figures 1 and 2). To run at their fastest conversion rates (600ns), they must be clocked at 14.4MHz. HC logic families and any high speed ASIC or PLD will easily interface to the ADCs at that speed (see Data Transfer and Typical Application sections). Full speed operation from a 3V supply can still be achieved with 3V ASICs, PLDs or HC logic circuits.

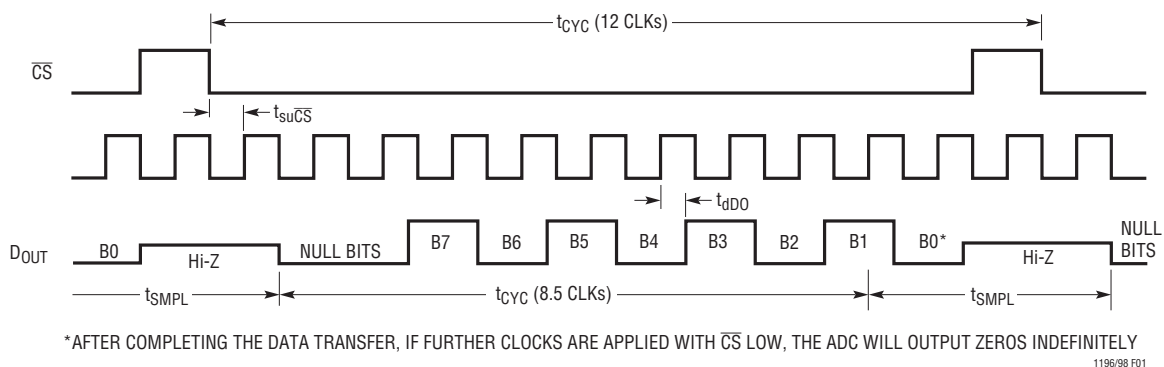

Figure 1. LTC1196 Operating Sequence

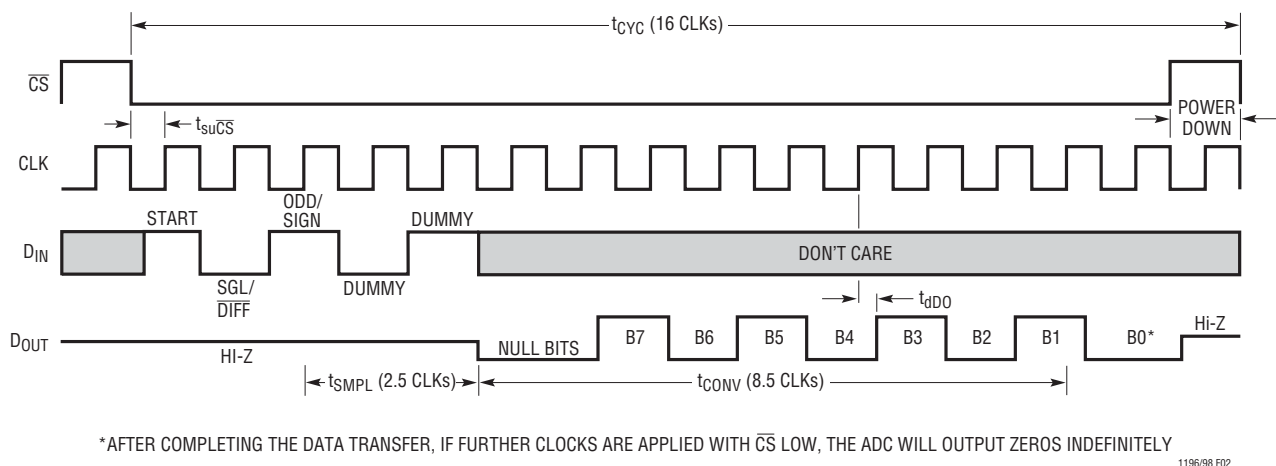

Figure 2. LTC1198 Operating Sequence Example: Differential Inputs (CH1, CH0)

## APPLICATIONS INFORMATION

Connection to a microprocessor or a DSP serial port is quite simple (see Data Transfer section). It requires no additional hardware, but the speed will be limited by the clock rate of the microprocessor or the DSP which limits the conversion time of the LTC1196/LTC1198.

### Data Transfer

Data transfer differs slightly between the LTC1196 and the LTC1198. The LTC1196 interfaces over 3 lines:  $\overline{CS}$ , CLK and  $D_{OUT}$ . A falling  $\overline{CS}$  initiates data transfer as shown in the LTC1196 Operating Sequence. After  $\overline{CS}$  falls, the first CLK pulse enables  $D_{OUT}$ . After two null bits, the A/D conversion result is output on the  $D_{OUT}$  line. Bringing  $\overline{CS}$  high resets the LTC1196 for the next data exchange.

The LTC1198 can transfer data with 3 or 4 wires. The additional input,  $D_{IN}$ , is used to select the 2-channel MUX configuration.

The data transfer between the LTC1198 and the digital systems can be broken into two sections: Input Data Word and A/D Conversion Result. First, each bit of the input data word is captured on the rising CLK edge by the LTC1198. Second, each bit of the A/D conversion result on the  $D_{OUT}$  line is updated on the rising CLK edge by the LTC1198. This bit should be captured on the next rising CLK edge by the digital systems (see A/D Conversion Result section).

Data transfer is initiated by a falling chip select ( $\overline{CS}$ ) signal as shown in the LTC1198 Operating Sequence. After  $\overline{CS}$  falls the LTC1198 looks for a start bit. After the start bit is received, the 4-bit input word is shifted into the  $D_{IN}$  input. The first two bits of the input word configure the LTC1198. The last two bits of the input word allow the ADC to acquire the input voltage by 2.5 clocks before the conversion starts. After the conversion starts, two null bits and the conversion result are output on the  $D_{OUT}$  line. At

the end of the data exchange  $\overline{CS}$  should be brought high. This resets the LTC1198 in preparation for the next data exchange.

### Input Data Word

The LTC1196 requires no  $D_{IN}$  word. It is permanently configured to have a single differential input. The conversion result is output on the  $D_{OUT}$  line in an MSB-first sequence, followed by zeros indefinitely if clocks are continuously applied with  $\overline{CS}$  low.

The LTC1198 clocks data into the  $D_{IN}$  input on the rising edge of the clock. The input data word is defined as follows:

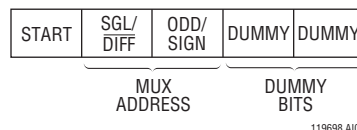

### Start Bit

The first “logical one” clocked into the  $D_{IN}$  input after  $\overline{CS}$  goes low is the start bit. The start bit initiates the data transfer. The LTC1198 will ignore all leading zeros which precede this logical one. After the start bit is received, the remaining bits of the input word will be clocked in. Further inputs on the  $D_{IN}$  pin are then ignored until the next  $\overline{CS}$  cycle.

### Multiplexer (MUX) Address

The 2 bits of the input word following the START bit assign the MUX configuration for the requested conversion. For a given channel selection, the converter will measure the voltage between the two channels indicated by the “+” and “-” signs in the selected row of the following table. In single-ended mode, all input channels are measured with respect to GND.

LTC1198 Channel Selection

		MUX ADDRESS		CHANNEL #		
		SGL/DIFF	ODD/SIGN	0	1	GND
SINGLE-ENDED MUX MODE	1	0	+	-		
	1	1	+	-		
DIFFERENTIAL MUX MODE	0	0	+	-		
	0	1	-	+		

1196/98 AI03

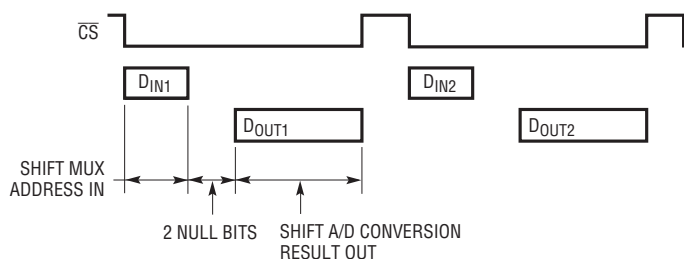

## APPLICATIONS INFORMATION

### Dummy Bits

The last 2 bits of the input word following the MUX Address are dummy bits. Either bit can be a “logical one” or a “logical zero.” These 2 bits allow the ADC 2.5 clocks to acquire the input signal after the channel selection.

### A/D Conversion Result

Both the LTC1196 and the LTC1198 have the A/D conversion result appear on the D<sub>OUT</sub> line after two null bits (see Operating Sequence in Figures 1 and 2). Data on the D<sub>OUT</sub> line is updated on the rising edge of the CLK line. The D<sub>OUT</sub> data should also be captured on the rising CLK edge by the digital systems. Data on the D<sub>OUT</sub> line remains valid for a minimum time of t<sub>hDO</sub> (30ns at 5V) to allow the capture to occur (see Figure 3).

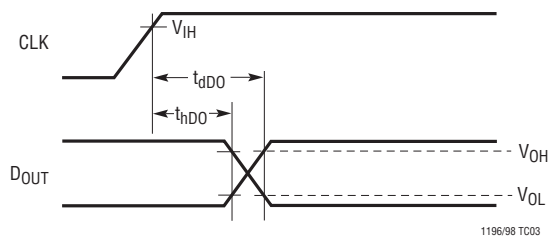
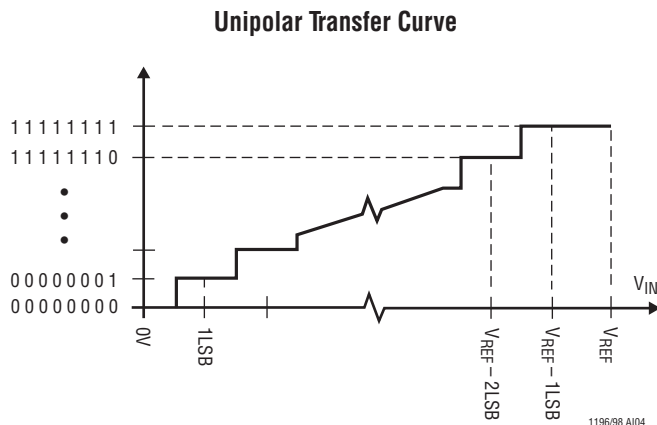

Figure 3. Voltage Waveform for D<sub>OUT</sub> Delay Time, t<sub>dDO</sub> and t<sub>hDO</sub>

### Unipolar Transfer Curve

The LTC1196/LTC1198 are permanently configured for unipolar only. The input span and code assignment for this conversion type are shown in the following figures.



### Unipolar Output Code

OUTPUT CODE	INPUT VOLTAGE	INPUT VOLTAGE (V <sub>REF</sub> = 5.000V)
1 1 1 1 1 1 1 1	V <sub>REF</sub> - 1LSB	4.9805V
1 1 1 1 1 1 1 0	V <sub>REF</sub> - 2LSB	4.9609V
⋮	⋮	⋮
0 0 0 0 0 0 0 1	1LSB	0.0195V
0 0 0 0 0 0 0 0	0V	0V

1196/98 AI05

### Operation with D<sub>IN</sub> and D<sub>OUT</sub> Tied Together

The LTC1198 can be operated with D<sub>IN</sub> and D<sub>OUT</sub> tied together. This eliminates one of the lines required to communicate to the digital systems. Data is transmitted in both directions on a single wire. The pin of the digital systems connected to this data line should be configurable as either an input or an output. The LTC1198 will take control of the data line and drive it low on the 5th falling CLK edge after the start bit is received (see Figure 4). Therefore the port line of the digital systems must be switched to an input before this happens to avoid a conflict.

### REDUCING POWER CONSUMPTION

The LTC1196/LTC1198 can sample at up to a 1MHz rate, drawing only 50mW from a 5V supply. Power consumption can be reduced in two ways. Using a 3V supply lowers the power consumption on both devices by a factor of five, to 10mW. The LTC1198 can reduce power even further because it shuts down whenever it is not converting. Figure 5 shows the supply current versus sample rate for the LTC1196 and LTC1198 on 3V and 5V. To achieve such a low power consumption, especially for the LTC1198, several things must be taken into consideration.

### Shutdown (LTC1198)

Figure 2 shows the operating sequence of the LTC1198. The converter draws power when the  $\overline{CS}$  pin is low and powers itself down when that pin is high. For lowest power consumption in shutdown, the  $\overline{CS}$  pin should be driven with CMOS levels (0V to V<sub>CC</sub>) so that the  $\overline{CS}$  input buffer of the converter will not draw current.



## APPLICATIONS INFORMATION

Figure 4. LTC1198 Operation with  $D_{IN}$  and  $D_{OUT}$  Tied Together

Figure 5. Supply Current vs Sample Rate for LTC1196/LTC1198 Operating on 5V and 2.7V Supplies

When the  $\overline{CS}$  pin is high (= supply voltage), the LTC1198 is in shutdown mode and draws only leakage current. The status of the  $D_{IN}$  and CLK input has no effect on the supply current during this time. There is no need to stop  $D_{IN}$  and CLK with  $\overline{CS}$  = high; they can continue to run without drawing current.

### Minimize $\overline{CS}$ Low Time (LTC1198)

In systems that have significant time between conversions, lowest power drain will occur with the minimum  $\overline{CS}$  low time. Bringing  $\overline{CS}$  low, transferring data as quickly as possible, then bringing it back high will result in the lowest current drain. This minimizes the amount of time the device draws power.

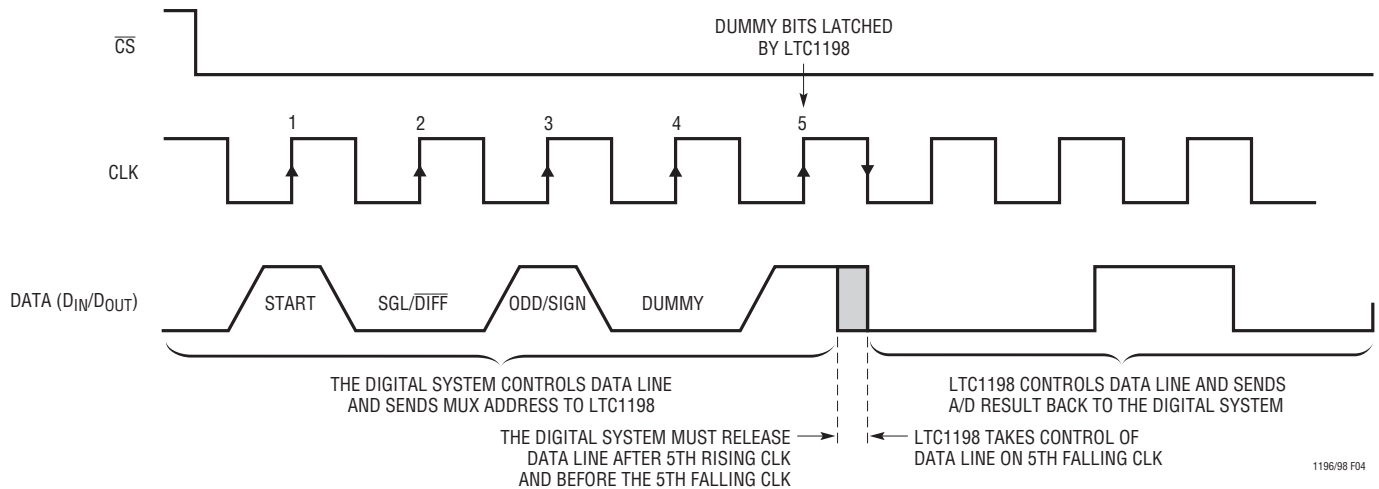
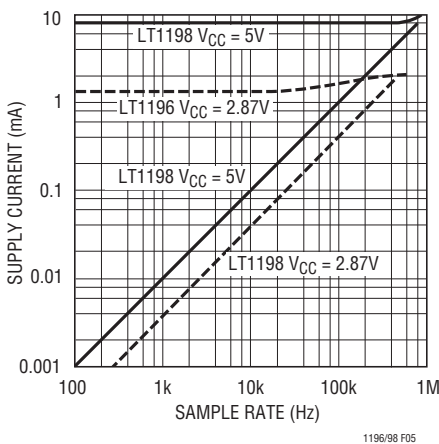
### OPERATING ON OTHER THAN 5V SUPPLIES

The LTC1196/LTC1198 operate from single 2.7V to 6V supplies. To operate the LTC1196/LTC1198 on other than 5V supplies, a few things must be kept in mind.

### Input Logic Levels

The input logic levels of  $\overline{CS}$ , CLK and  $D_{IN}$  are made to meet TTL on 5V supply. When the supply voltage varies, the input logic levels also change (see typical curve of Digital Input Logic Threshold vs Supply Voltage). For these two ADCs to sample and convert correctly, the digital inputs have to be in the logical low and high relative to the operating supply voltage. If achieving micropower consumption is desirable on the LTC1198, the digital inputs must go rail-to-rail between supply voltage and ground (see Reducing Power Consumption section).

## APPLICATIONS INFORMATION

### Clock Frequency

The maximum recommended clock frequency is 14.4MHz at 25°C for the LTC1196/LTC1198 running off a 5V supply. With the supply voltage changing, the maximum clock frequency for the devices also changes (see the typical curve of Maximum Clock Rate vs Supply Voltage). If the supply is reduced, the clock rate must be reduced also. At 3V the devices are specified with a 5.4MHz clock at 25°C.

### Mixed Supplies

It is possible to have a digital system running off a 5V supply and communicate with the LTC1196/LTC1198 operating on a 3V supply. Achieving this reduces the outputs of  $D_{OUT}$  from the ADCs to toggle the equivalent input of the digital system. The  $\overline{CS}$ , CLK and  $D_{IN}$  inputs of the ADCs will take 5V signals from the digital system without causing any problem (see typical curve of Digital Input Logic Threshold vs Supply Voltage). With the LTC1196 operating on a 3V supply, the output of  $D_{OUT}$  only goes between 0V and 3V. This signal easily meets TTL levels (see Figure 6).

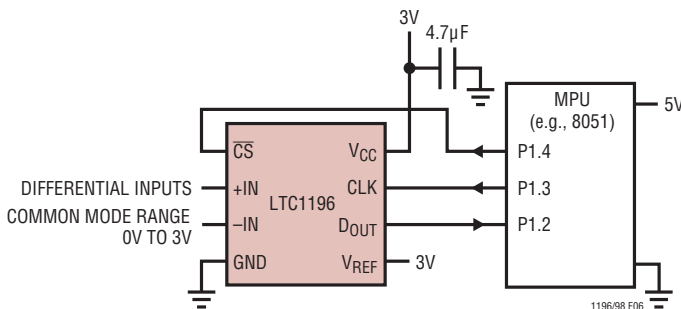

Figure 6. Interfacing a 3V Powered LTC1196 to a 5V System

## BOARD LAYOUT CONSIDERATIONS

### Grounding and Bypassing

The LTC1196/LTC1198 are easy to use if some care is taken. They should be used with an analog ground plane and single-point grounding techniques. The GND pin should be tied directly to the ground plane.

The  $V_{CC}$  pin should be bypassed to the ground plane with a 1µF tantalum with leads as short as possible. If the power

supply is clean, the LTC1196/LTC1198 can also operate with smaller 0.1µF surface mount or ceramic bypass capacitors. All analog inputs should be referenced directly to the single-point ground. Digital inputs and outputs should be shielded from and/or routed away from the reference and analog circuitry.

### SAMPLE-AND-HOLD

Both the LTC1196 and the LTC1198 provide a built-in sample-and-hold (S&H) function to acquire the input signal. The S&H acquires the input signal from “+” input during  $t_{SMPL}$  as shown in Figures 1 and 2. The S&H of the LTC1198 can sample input signals in either single-ended or differential mode (see Figure 7).

### Single-Ended Inputs

The sample-and-hold of the LTC1198 allows conversion of rapidly varying signals. The input voltage is sampled during the  $t_{SMPL}$  time as shown in Figure 7. The sampling interval begins as the bit preceding the first DUMMY bit is shifted in and continues until the falling CLK edge after the second DUMMY bit is received. On this falling edge, the S&H goes into hold mode and the conversion begins.

### Differential Inputs

With differential inputs, the ADC no longer converts just a single voltage but rather the difference between two voltages. In this case, the voltage on the selected “+” input is still sampled and held and therefore may be rapidly time varying just as in single-ended mode. However, the voltage on the selected “-” input must remain constant and be free of noise and ripple throughout the conversion time. Otherwise, the differencing operation may not be performed accurately. The conversion time is 8.5 CLK cycles. Therefore, a change in the “-” input voltage during this interval can cause conversion errors. For a sinusoidal voltage on the “-” input, this error would be:

$$V_{ERROR(MAX)} = V_{PEAK} \cdot 2 \cdot \pi \cdot f(“-”) \cdot 8.5/f_{CLK}$$

where  $f(“-”)$  is the frequency of the “-” input voltage,  $V_{PEAK}$  is its peak amplitude and  $f_{CLK}$  is the frequency of the CLK.

## APPLICATIONS INFORMATION

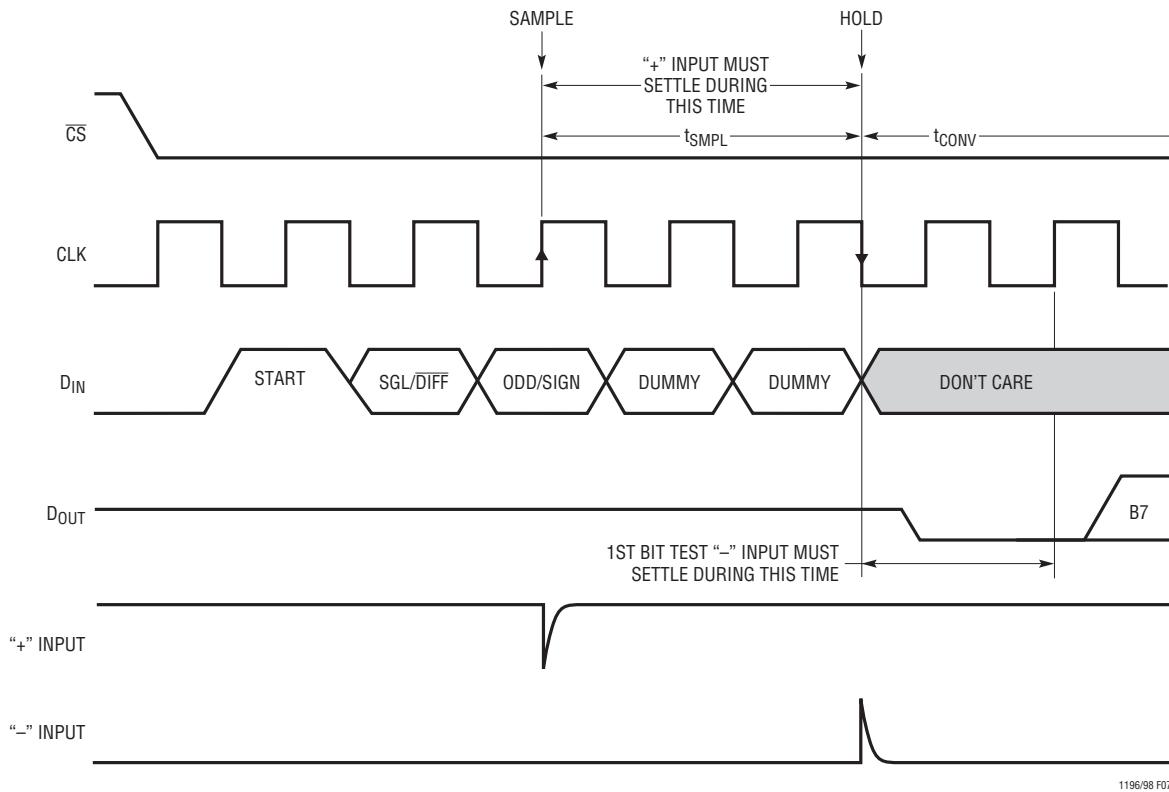

Figure 7. LTC1198 “+” and “-” Input Settling Windows

$V_{ERROR}$  is proportional to  $f(“-”)$  and inversely proportional to  $f_{CLK}$ . For a 60Hz signal on the “-” input to generate a 1/4LSB error (5mV) with the converter running at  $CLK = 12MHz$ , its peak value would have to be 18.7V.

## ANALOG INPUTS

Because of the capacitive redistribution A/D conversion techniques used, the analog inputs of the LTC1196/LTC1198 have one capacitive switching input current spike per conversion. These current spikes settle quickly and do not cause a problem. However, if source resistances larger than  $100\Omega$  are used or if slow settling op amps drive the inputs, care must be taken to insure that the transients caused by the current spikes settle completely before the conversion begins.

## “+” Input Settling

The input capacitor of the LTC1196 is switched onto “+” input at the end of the conversion and samples the input signal until the conversion begins (see Figure 1). The input capacitor of the LTC1198 is switched onto “+” input during the sample phase ( $t_{SMPL}$ , see Figure 7). The sample phase is 2.5 CLK cycles before conversion starts. The voltage on the “+” input must settle completely within  $t_{SMPL}$  for the LTC1196/LTC1198. Minimizing  $R_{SOURCE}^+$  will improve the input settling time. If a large “+” input source resistance must be used, the sample time can be increased by allowing more time between conversions for the LTC1196 or by using a slower CLK frequency for the LTC1198.

## APPLICATIONS INFORMATION

### “–” Input Settling

At the end of the  $t_{SMPL}$ , the input capacitor switches to the “–” input and conversion starts (see Figures 1 and 7). During the conversion, the “+” input voltage is effectively “held” by the sample-and-hold and will not affect the conversion result. However, it is critical that the “–” input voltage settle completely during the first CLK cycle of the conversion time and be free of noise. Minimizing  $R_{SOURCE^-}$  will improve settling time. If a large “–” input source resistance must be used, the time allowed for settling can be extended by using a slower CLK frequency.

### Input Op Amps

When driving the analog inputs with an op amp it is important that the op amp settle within the allowed time (see Figures 1 and 7). Again, the “+” and “–” input sampling times can be extended as described above to accommodate slower op amps.

To achieve the full sampling rate, the analog input should be driven with a low impedance source ( $<100\Omega$ ) or a high speed op amp (e.g., the LT1223, LT1191 or LT1226). Higher impedance sources or slower op amps can easily be accommodated by allowing more time for the analog input to settle as described above.

### Source Resistance

The analog inputs of the LTC1196/LTC1198 look like a 25pF capacitor ( $C_{IN}$ ) in series with a  $120\Omega$  resistor ( $R_{ON}$ ) as shown in Figure 8.  $C_{IN}$  gets switched between the selected “+” and “–” inputs once during each conversion cycle. Large external source resistors will slow the settling of the inputs. It is important that the overall RC time constants be short enough to allow the analog inputs to completely settle within  $t_{SMPL}$ .

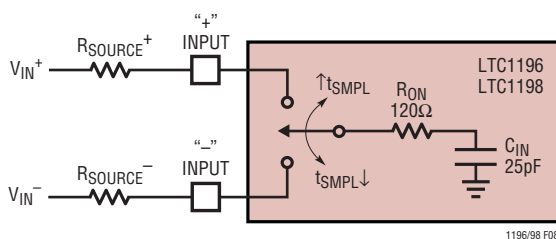

Figure 8. Analog Input Equivalent Circuit

### REFERENCE INPUT

The voltage on the reference input of the LTC1196 defines the voltage span of the A/D converter. The reference input has transient capacitive switching currents which are due to the switched-capacitor conversion technique (see Figure 9). During each bit test of the conversion (every CLK cycle), a capacitive current spike will be generated on the reference pin by the ADC. These high frequency current spikes will settle quickly and do not cause a problem if the reference input is bypassed with at least a  $0.1\mu\text{F}$  capacitor.

The reference input can be driven with standard voltage references. Bypassing the reference with a  $0.1\mu\text{F}$  capacitor is recommended to keep the high frequency impedance low as described above. Some references require a small resistor in series with the bypass capacitor for frequency stability. See the individual reference data sheet for details.

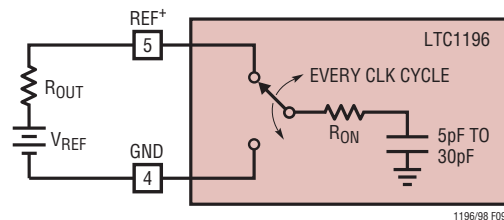

Figure 9. Reference Input Equivalent Circuit

### Reduced Reference Operation

The minimum reference voltage of the LTC1198 is limited to 2.7V because the  $V_{CC}$  supply and reference are internally tied together. However, the LTC1196 can operate with reference voltages below 1V.

The effective resolution of the LTC1196 can be increased by reducing the input span of the converter. The LTC1196 exhibits good linearity and gain over a wide range of reference voltages (see typical curves of Linearity and Full-Scale Error vs Reference Voltage). However, care must be taken when operating at low values of  $V_{REF}$  because of the reduced LSB step size and the resulting higher accuracy requirement placed on the converter. The following factors must be considered when operating at low  $V_{REF}$  values.

1. Offset
2. Noise

## APPLICATIONS INFORMATION

### Offset with Reduced $V_{REF}$

The offset of the LTC1196 has a larger effect on the output code when the ADC is operated with reduced reference voltage. The offset (which is typically a fixed voltage) becomes a larger fraction of an LSB as the size of the LSB is reduced. The typical curve of Unadjusted Offset Error vs Reference Voltage shows how offset in LSBs is related to reference voltage for a typical value of  $V_{OS}$ . For example, a  $V_{OS}$  of 2mV which is 0.1LSB with a 5V reference becomes 0.5LSB with a 1V reference and 2.5LSB with a 0.2V reference. If this offset is unacceptable, it can be corrected digitally by the receiving system or by offsetting the “-” input of the LTC1196.

### Noise with Reduced $V_{REF}$

The total input referred noise of the LTC1196 can be reduced to approximately 2mV<sub>P-P</sub> using a ground plane, good bypassing, good layout techniques and minimizing noise on the reference inputs. This noise is insignificant with a 5V reference but will become a larger fraction of an LSB as the size of the LSB is reduced.

For operation with a 5V reference, the 2mV noise is only 0.1LSB peak-to-peak. In this case, the LTC1196 noise will contribute virtually no uncertainty to the output code. However, for reduced references, the noise may become a significant fraction of an LSB and cause undesirable jitter in the output code. For example, with a 1V reference, this same 2mV noise is 0.5LSB peak-to-peak. This will reduce the range of input voltages over which a stable output code can be achieved by 1LSB. If the reference is further reduced to 200mV, the 2mV noise becomes equal to 2.5LSB and a stable code is difficult to achieve. In this case averaging readings is necessary.

This noise data was taken in a very clean setup. Any setup induced noise (noise or ripple on  $V_{CC}$ ,  $V_{REF}$  or  $V_{IN}$ ) will add to the internal noise. The lower the reference voltage to be used, the more critical it becomes to have a clean, noise-free setup.

## DYNAMIC PERFORMANCE

The LTC1196/LTC1198 have exceptionally high speed sampling capability. Fast Fourier Transform (FFT) test techniques are used to characterize the ADC's frequency response, distortion and noise at the rated throughput. By applying a low distortion sine wave and analyzing the digital output using a FFT algorithm, the ADC's spectral content can be examined for frequencies outside the fundamental. Figure 10 shows a typical LTC1196 FFT plot.

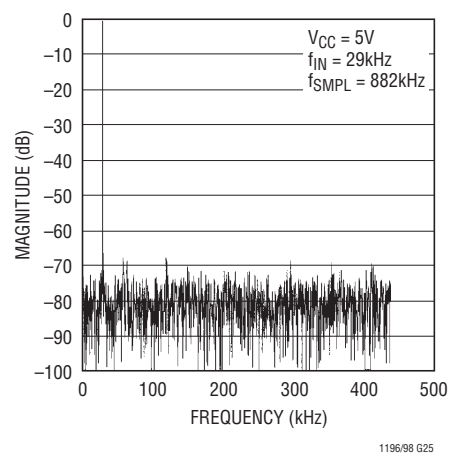

Figure 10. LTC1196 Non-Averaged, 4096 Point FFT Plot

### Signal-to-Noise Ratio

The Signal-to-Noise plus Distortion Ratio  $[S/(N + D)]$  is the ratio between the RMS amplitude of the fundamental input frequency to the RMS amplitude of all other frequency components at the ADC's output. The output is band limited to frequencies above DC and below one half the sampling frequency. Figure 10 shows a typical spectral content with a 882kHz sampling rate.

### Effective Number of Bits

The Effective Number of Bits (ENOBs) is a measurement of the resolution of an ADC and is directly related to  $S/(N + D)$  by the equation:

$$N = [S/(N + D) - 1.76]/6.02$$

## APPLICATIONS INFORMATION

where N is the effective number of bits of resolution and  $S/(N + D)$  is expressed in dB. At the maximum sampling rate of 1.2MHz with a 5V supply the LTC1196 maintains above 7.5 ENOBs at 400kHz input frequency. Above 500kHz the ENOBs gradually decline, as shown in Figure 11, due to increasing second harmonic distortion. The noise floor remains low.

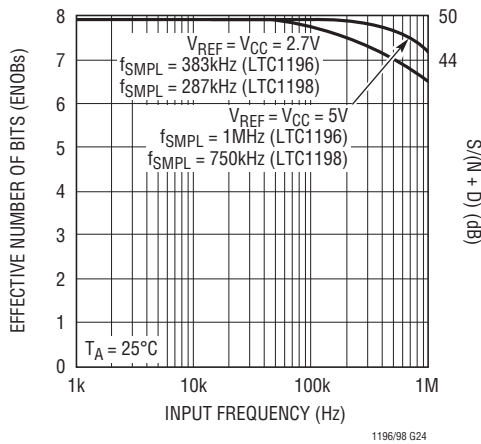

Figure 11. Effective Bits and  $S/(N + D)$  vs Input Frequency

### Total Harmonic Distortion

Total Harmonic Distortion (THD) is the ratio of the RMS sum of all harmonics of the input signal to the fundamental itself. The out-of-band harmonics alias into the frequency band between DC and half of the sampling frequency. THD is defined as:

$$THD = 20 \log \frac{\sqrt{V_2^2 + V_3^2 + V_4^2 + \dots + V_N^2}}{V_1}$$

where  $V_1$  is the RMS amplitude of the fundamental frequency and  $V_2$  through  $V_N$  are the amplitudes of the second through the Nth harmonics. The typical THD specification in the Dynamic Accuracy table includes the 2nd through 5th harmonics. With a 100kHz input signal, the LTC1196/LTC1198 have typical THD of 50dB and 49dB with  $V_{CC} = 5V$  and  $V_{CC} = 3V$ , respectively.

### Intermodulation Distortion

If the ADC input signal consists of more than one spectral component, the ADC transfer function nonlinearity can

produce intermodulation distortion (IMD) in addition to THD. IMD is the change in one sinusoidal input caused by the presence of another sinusoidal input at a different frequency.

If two pure sine waves of frequencies  $f_a$  and  $f_b$  are applied to the ADC input, nonlinearities in the ADC transfer function can create distortion products at sum and difference frequencies of  $mf_a \pm nf_b$ , where m and n = 0, 1, 2, 3, etc. For example, the 2nd order IMD terms include  $(f_a + f_b)$  and  $(f_a - f_b)$  while 3rd order IMD terms include  $(2f_a + f_b)$ ,  $(2f_a - f_b)$ ,  $(f_a + 2f_b)$  and  $(f_a - 2f_b)$ . If the two input sine waves are equal in magnitudes, the value (in dB) of the 2nd order IMD products can be expressed by the following formula:

$$IMD(f_a \pm f_b) = 20 \log \left[ \frac{\text{amplitude}(f_a \pm f_b)}{\text{amplitude at } f_a} \right]$$

For input frequencies of 499kHz and 502kHz, the IMD of the LTC1196/LTC1198 is 51dB with a 5V supply.

### Peak Harmonic or Spurious Noise

The peak harmonic or spurious noise is the largest spectral component excluding the input signal and DC. This value is expressed in dBs relative to the RMS value of a full-scale input signal.

### Full-Power and Full-Linear Bandwidth

The full-power bandwidth is that input frequency at which the amplitude of the reconstructed fundamental is reduced by 3dB for a full-scale input.

The full-linear bandwidth is the input frequency at which the effective bits rating of the ADC falls to 7 bits. Beyond this frequency, distortion of the sampled input signal increases. The LTC1196/LTC1198 have been designed to optimize input bandwidth, allowing the ADCs to undersample input signals with frequencies above the converters' Nyquist Frequency.

## APPLICATIONS INFORMATION

### 3V VERSUS 5V PERFORMANCE COMPARISON

Table 1 shows the performance comparison between 3V and 5V supplies. The power dissipation drops by a factor of five when the supply is reduced to 3V. The converter slows down somewhat but still gives excellent performance on a 3V rail. With a 3V supply, the LTC1196 converts in 1.6 $\mu$ s, samples at 450kHz, and provides a 500kHz linear input bandwidth.

Dynamic accuracy is excellent on both 5V and 3V. The ADCs typically provide 49.3dB of 7.9 ENOBs of dynamic accuracy at both 3V and 5V. The noise floor is extremely low, corresponding to a transition noise of less than 0.1LSB. DC accuracy includes  $\pm 0.5$ LSB total unadjusted error at 5V. At 3V, linearity error is  $\pm 0.5$ LSB while total unadjusted error increases to  $\pm 1$ LSB.

Table 1. 5V/3V Performance Comparison

LTC1196-1	5V	3V
P <sub>DISS</sub>	50mW	10mW
Max f <sub>SAMPL</sub>	1MHz	383kHz
Min t <sub>CONV</sub>	600ns	1.6 $\mu$ s
INL (Max)	0.5LSB	0.5LSB
Typical ENOBs	7.9 at 300kHz	7.9 at 100kHz
Linear Input Bandwidth (ENOBs > 7)	1MHz	500kHz
LTC1198-1		
P <sub>DISS</sub>	50mW	10mW
P <sub>DISS</sub> (Shutdown)	15 $\mu$ W	9 $\mu$ W
Max f <sub>SAMPL</sub>	750kHz	287kHz
Min t <sub>CONV</sub>	600ns	1.6 $\mu$ s
INL (Max)	0.5LSB	0.5LSB
Typical ENOBs	7.9 at 300kHz	7.9 at 100kHz
Linear Input Bandwidth (ENOBs > 7)	1MHz	500kHz

## TYPICAL APPLICATIONS

### PLD Interface Using the Altera EPM5064

The Altera EPM5064 has been chosen to demonstrate the interface between the LTC1196 and a PLD. The EPM5064 is programmed to be a 12-bit counter and an equivalent 74HC595 8-bit shift register as shown in Figure 12. The circuit works as follows: bringing ENA high makes the  $\overline{CS}$  output high and the EN input low to reset the LTC1196 and disable the shift register. Bringing ENA low, the  $\overline{CS}$  output

goes high for one CLK cycle with every 12 CLK cycles. The inverted signal, EN, of the  $\overline{CS}$  output makes the 8-bit data available on the B0-B7 lines. Figures 13 and 14 show the interconnection between the LTC1196 and EPM5064 and the timing diagram of the signals between these two devices. The CLK frequency in this circuit can run up to f<sub>CLK(MAX)</sub> of the LTC1196.

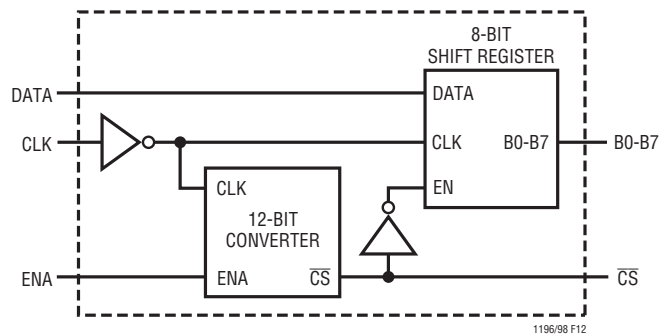

Figure 12. An Equivalent Circuit of the EPM5064

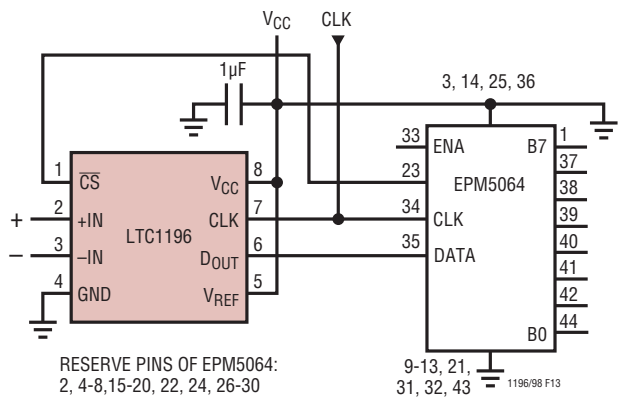

Figure 13. Interfacing the LTC1196 to the Altera EMP5064 PLD

## TYPICAL APPLICATIONS

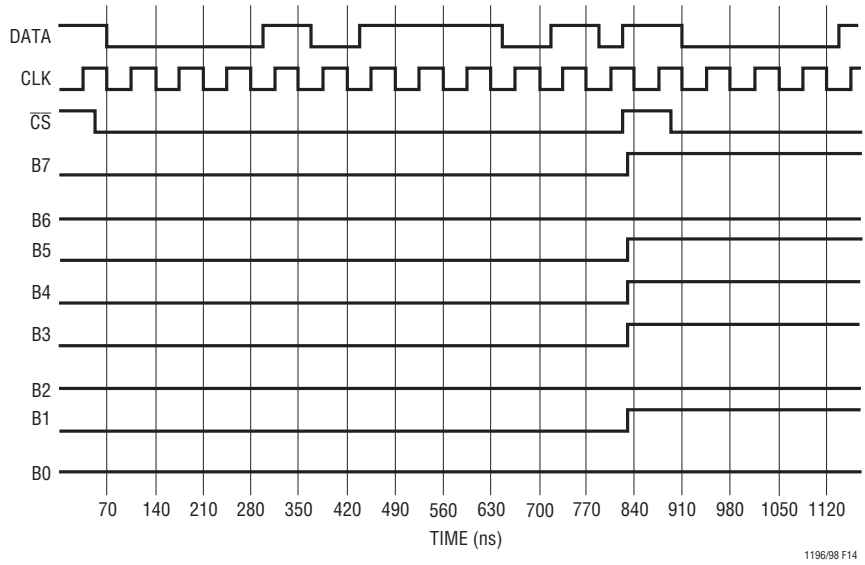

Figure 14. The Timing Diagram

### Interfacing the LTC1198 to the TMS320C25 DSP

Figure 15 illustrates the interface between the LTC1198 8-bit data acquisition system and the TMS320C25 digital signal processor (DSP). The interface, which is optimized for speed of transfer and minimum processor supervision, can complete a conversion and shift the data in 4μs with  $f_{CLK} = 5\text{MHz}$ . The cycle time, 4μs, of each conversion is limited by maximum clock frequency of the serial port of the TMS320C25 which is 5MHz. The supply voltage for the

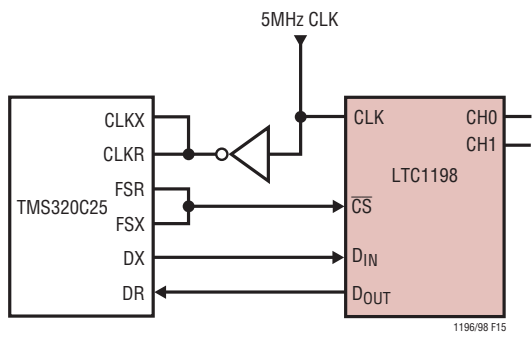

Figure 15. Interfacing the LTC1198 to the TMS320C25 DSP

LTC1198 in Figure 15 can be 2.7V to 6V with  $f_{CLK} = 5\text{MHz}$ . At 2.7V,  $f_{CLK} = 5\text{MHz}$  will work at 25°C. See Recommended Operating Conditions for limits over temperature.

### Hardware Description

The circuit works as follows: the LTC1198 clock line controls the A/D conversion rate and the data shift rate. Data is transferred in a synchronous format over  $D_{IN}$  and  $D_{OUT}$ . The serial port of the TMS320C25 is compatible with that of the LTC1198. The data shift clock lines (CLKR, CLKX) are inputs only. The data shift clock comes from an external source. Inverting the shift clock is necessary because the LTC1198 and the TMS320C25 clock the input data on opposite edges.

The schematic of Figure 15 is fed by an external clock source. The signal is fed into the CLK pin of the LTC1198 directly. The signal is inverted with a 74HC04 and then applied to the data shift clock lines (CLKR, CLKX). The framing pulse of the TMS320C25 is fed directly to the  $\overline{CS}$  of the LTC1198. DX and DR are tied directly to  $D_{IN}$  and  $D_{OUT}$  respectively.



## TYPICAL APPLICATIONS

The timing diagram of Figure 16 was obtained from the circuit of Figure 15. The CLK was 5MHz for the timing diagram and the TMS320C25 clock rate was 40MHz. Figure 17 shows the timing diagram with the LTC1198 running off a 2.7V supply and 5MHz CLK.

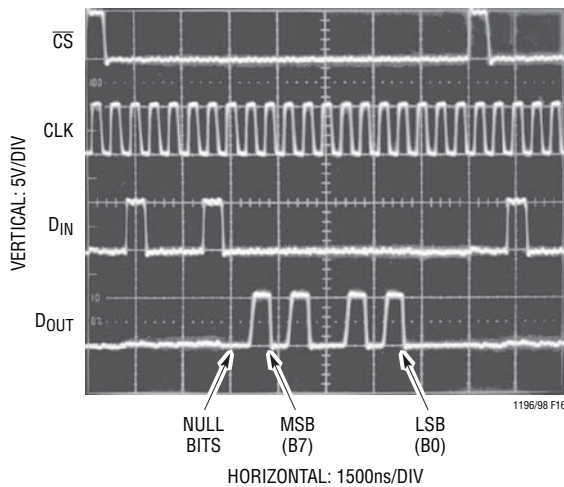

**Figure 16. Scope Trace the LTC1198 Running Off 5V Supply in the Circuit of Figure 15**

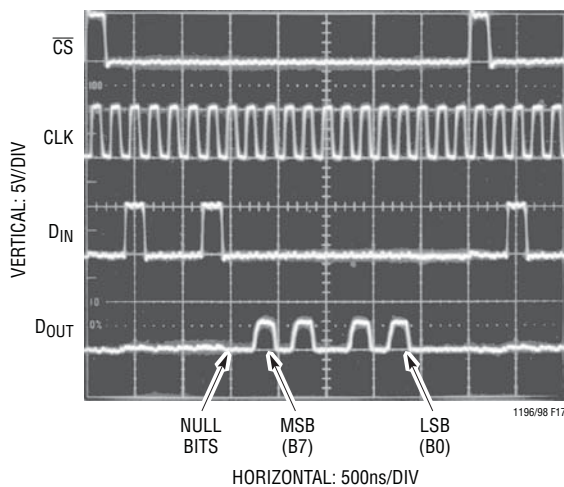

**Figure 17. Scope Trace the LTC1198 Running Off 1.7V Supply in the Circuit of Figure 15**

### Software Description

The software configures and controls the serial port of the TMS320C25.

The code first sets up the interrupt and reset vectors. On reset the TMS320C25 starts executing code at the label INIT. Upon completion of a 16-bit data transfer, an interrupt is generated and the DSP will begin executing code at the label RINT.

In the beginning, the code initializes registers in the TMS320C25 that will be used in the transfer routine. The interrupts are temporarily disabled. The data memory page pointer register is set to zero. The auxiliary register pointer is loaded with one and auxiliary register one is loaded with the value 200 hexadecimal. This is the data memory location where the data from the LTC1198 will be stored. The interrupt mask register (IMR) is configured to recognize the RINT interrupt, which is generated after receiving the last of 16 bits on the serial port. This interrupt is still disabled at this time. The transmit framing synchronization pin (FSX) is configured to be an output. The F0 bit of the status register ST1, is initialized to zero which sets up the serial port to operate in the 16-bit mode.

Next, the code in TXRX routine starts to transmit and receive data. The DIN word is loaded into the ACC and shifted left eight times so that it appears as in Figure 18. This DIN word configures the LTC1198 for CH0 with respect to CH1. The DIN word is then put in the transmit register and the RINT interrupt is enabled. The NOP is repeated 3 times to mask out the interrupts and minimize the cycle time of the conversion to be 20 clock cycles. All clocking and CS functions are performed by the hardware.

B15							B8	
0	1	0	0	0	1	0	0	
	START	S/D	O/S	DUMMY	DUMMY			

L1196/98 F18

**Figure 18. DIN Word in ACC of TMS20C25 for the Circuit in Figure 15**

## TYPICAL APPLICATIONS

Once RINT is generated the code begins execution at the label RINT. This code stores the D<sub>OUT</sub> word from the LTC1198 in the ACC and then stores it in location 200 hex. The data appears in location 200 hex right-justified as shown in Figure 19. The code is set up to continually loop, so at this point the code jumps to label TXRX and repeats from here.

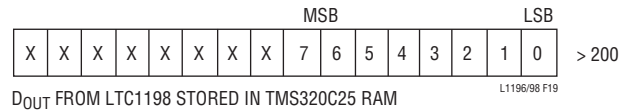

**Figure 19. Memory Map for the Circuit in Figure 15**

LABEL	MNEMONIC		COMMENTS
	AORG B	0 INIT	ON RESET CODE EXECUTION STARTS AT 0 BRANCH TO INITIALIZATION ROUTINE
	AORG B	>26 RINT	ADDRESS TO RINT INTERRUPT VECTOR BRANCH TO RINT SERVICE ROUTINE
INIT	AORG	>32	MAIN PROGRAM STARTS HERE
	DINT		DISABLE INTERRUPTS
	LDPK	>0	SET DATA MEMORY PAGE POINTER TO 0
	LARP	>1	SET AUXILIARY REGISTER POINTER TO 1
	LRLK	AR1, >200	SET AUXILIARY REGISTER 1 TO >200
	LACK	>10	LOAD IMR CONFIG WORD INTO ACC
	SACL	>4	STORE IMR CONFIG WORD INTO IMR
	STXM FORT	0	CONFIGURE FSX AS AN OUTPUT SET SERIAL PORT TO 16-BIT MODE
TXRX	LACK	>44	LOAD LTC1198 D <sub>IN</sub> WORD INTO ACC
	SFSM		FSX PULSES GENERATED ON XSR LOAD
	RPTK	7	REPEAT NEXT INSTRUCTION 8 TIMES
	SFL		SHIFTS D <sub>IN</sub> WORD TO RIGHT POSITION
	SACL	>1	PUT D <sub>IN</sub> WORD IN TRANSMIT REGISTER
	EINT		ENABLE INTERRUPT (DISABLE ON RINT)
	RPTK NOP	2	MINIMIZE THE CONVERSION CYCLE TIME TO BE 20 CLOCK CYCLES
RINT	ZALS	>0	STORE LTC1198 D <sub>OUT</sub> WORD IN ACC
	SACL	*, 0	STORE ACC IN LOCATION >200
	B	TXRX	BRANCH TO TRANSMIT RECEIVE ROUTINE
	END		

**Figure 20. TMS320C25 Code for the Circuit in Figure 15**

# PACKAGE DESCRIPTION

## S8 Package 8-Lead Plastic Small Outline (Narrow .150 Inch) (Reference LTC DWG # 05-08-1610)

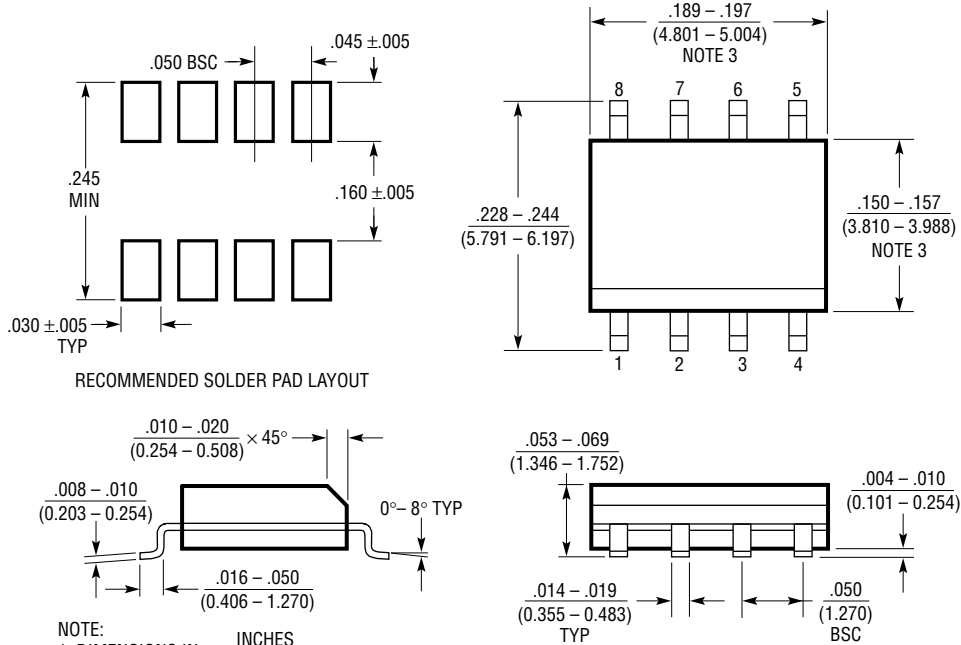

- NOTE:  
 1. DIMENSIONS IN INCHES (MILLIMETERS)  
 2. DRAWING NOT TO SCALE  
 3. THESE DIMENSIONS DO NOT INCLUDE MOLD FLASH OR PROTRUSIONS. MOLD FLASH OR PROTRUSIONS SHALL NOT EXCEED .006" (0.15mm)

S08 0303

## RELATED PARTS

PART NUMBER	DESCRIPTION	COMMENTS
<b>ADCs</b>		
LTC1402	12-Bit, 2.2Msps Serial ADC	5V or $\pm 5V$ Supply, 4.096V or $\pm 2.5V$ Span
LTC1403/LTC1403A	12-/14-Bit, 2.8Msps Serial ADCs	3V, 15mW, Unipolar Inputs, MSOP Package
LTC1403-1/LTC1403A-1	12-/14-Bit, 2.8Msps Serial ADCs	3V, 15mW, Bipolar Inputs, MSOP Package
LTC1405	12-Bit, 5Msps Parallel ADC	5V, Selectable Spans, 115mW
LTC1407/LTC1407A	12-/14-Bit, 3Msps Simultaneous Sampling ADCs	3V, 2-Channel Differential, Unipolar Inputs, 14mW, MSOP Package
LTC1407-1/LTC1407A-1	12-/14-Bit, 3Msps Simultaneous Sampling ADCs	3V, 2-Channel Differential, Bipolar Inputs, 14mW, MSOP Package
LTC1411	14-Bit, 2.5Msps Parallel ADC	5V, Selectable Spans, 80dB SINAD
LTC1412	12-Bit, 3Msps Parallel ADC	$\pm 5V$ Supply, $\pm 2.5V$ Span, 72dB SINAD
LCT1414	14-Bit, 2.2Msps Parallel ADC	$\pm 5V$ Supply, $\pm 2.5V$ Span, 78dB SINAD
LTC1420	12-Bit, 10Msps Parallel ADC	5V, Selectable Spans, 72dB SINAD
LTC1604	16-Bit, 333ksps Parallel ADC	$\pm 5V$ Supply, $\pm 2.5V$ Span, 90dB SINAD
LTC1608	16-Bit, 500ksps Parallel ADC	$\pm 5V$ Supply, $\pm 2.5V$ Span, 90dB SINAD
LTC1609	16-Bit, 250ksps Serial ADC	5V, Configurable Bipolar/Unipolar Inputs
LTC1864/LTC1865	16-Bit, 250ksps Serial ADCs	5V Supply, 1 and 2 Channel, 4.3mW, MSOP Package
LTC2355-12/ LTC2355-14	12-Bit, 3.5Msps Serial ADCs	3.3V Supply, 0V to 2.5V Span, MSOP Package
LTC2356-12/LTC2356-14	12-/14-Bit, 3.5Msps Serial ADCs	3.3V Supply, $\pm 1.25V$ Span, MSOP Package
<b>DACs</b>		
LTC1666/LTC1667/LTC1668	12-/14-/16-Bit, 50Msps DACs	87dB SFDR, 20ns Settling Time
LTC1592	16-Bit, Serial SoftSpan™ I <sub>OUT</sub> DAC	$\pm 1$ LSB INL/DNL, Software Selectable Spans
<b>References</b>		
LT1790-2.5	Micropower Series Reference in SOT-23	0.05% Initial Accuracy, 10ppm Drift
LT1461-2.5	Precision Voltage Reference	0.04% Initial Accuracy, 3ppm Drift
LT1460-2.5	Micropower Series Voltage Reference	0.1% Initial Accuracy, 10ppm Drift

SoftSpan is a trademark of Linear Technology Corporation.