

Features

- 2.3 INCH DIGIT HEIGHT.
- LOW CURRENT OPERATION.
- EXCELLENT CHARACTER APPEARANCE.
- HIGH LIGHT OUTPUT.
- EASY MOUNTING ON P.C.BOARDS OR SOCKETS.
- MULTICOLOR AVAILABLE.
- MECHANICALLY RUGGED.
- STANDARD : GRAY FACE, WHITE SEGMENT.
- RoHS COMPLIANT.

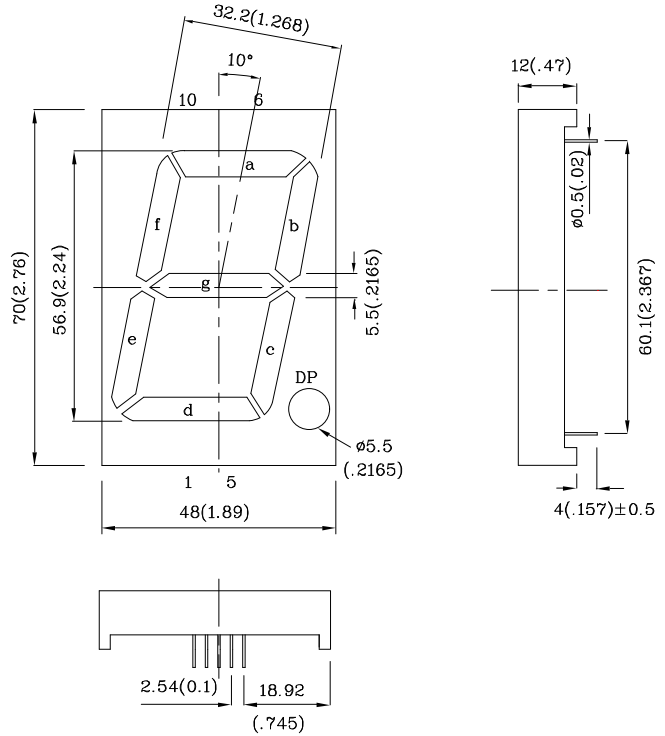
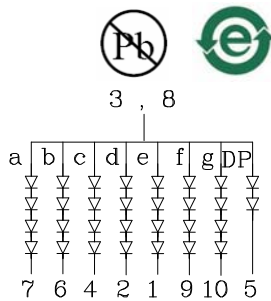

Notes:

1. All dimensions are in millimeters (inches).
2. Tolerance is $\pm 0.25(0.01")$ unless otherwise noted.
3. Specifications are subject to change without notice.

Absolute Maximum Ratings (TA=25°C)		MR (GaAlAs)	Unit
Reverse Voltage Per Segment Or (DP)	V _R	20(10)	V
Forward Current Per Segment Or (DP)	I _F	30	mA
Forward Current (peak) Per Segment Or (DP) 1/10Duty Cycle 0.1ms Pulse Width	i _{FS}	155	mA
Power Dissipation Per Segment Or (DP)	P _T	300(150)	mW
Operating Temperature	T _A	-40 ~ +85	°C
Storage Temperature	T _{stg}	-40 ~ +85	
Lead Solder Temperature [2mm Below Package Base]	260°C For 3~ 5 Seconds		

Operating Characteristics (TA=25°C)	MR (GaAlAs)	Unit
Forward Voltage (Typ.) Per Segment Or (DP) (IF=10mA)	V _F	7.2(3.6) V
Forward Voltage (Max.) Per Segment Or (DP) (IF=10mA)	V _F	10.0(5.0) V
Reverse Current Per Segment Or (Dp) (VR=20(10)V)	I _R	10 uA
Wavelength Of Peak Emission (Typ.) (IF=10mA)	λ P	660 nm
Wavelength Of Dominant Emission (Typ.) (IF=10mA)	λ D	640 nm
Spectral Line Full Width At Half-Maximum (Typ.) (IF=10mA)	Δλ	20 nm
Capacitance (Typ.) (VF=0V, f=1MHz)	C	45 pF

Part Number	Emitting Color	Emitting Material	Luminous Intensity (IF=10mA) ucd		Wavelength nm λ P	Description
			min.	typ.		
DMR57A	Red	GaAlAs	18000	74990	660	Common Anode,Rt.Hand Decimal

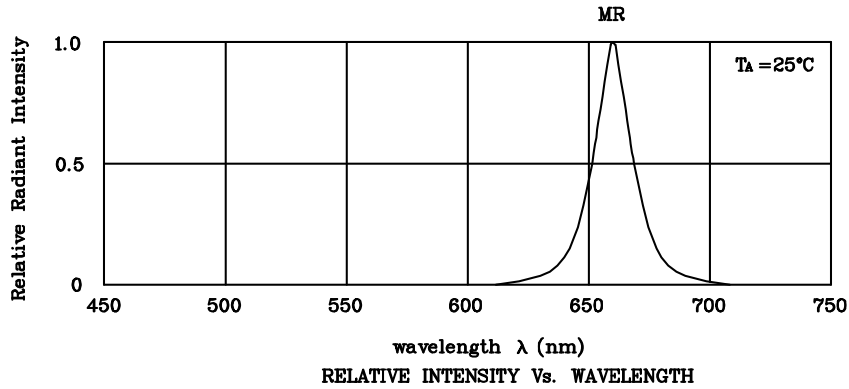

❖ **MR**

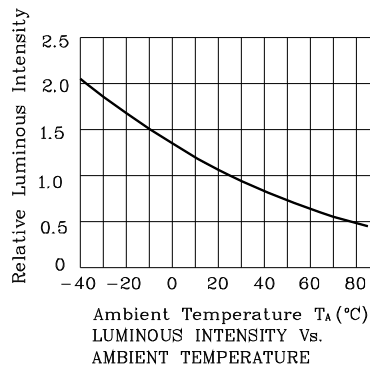
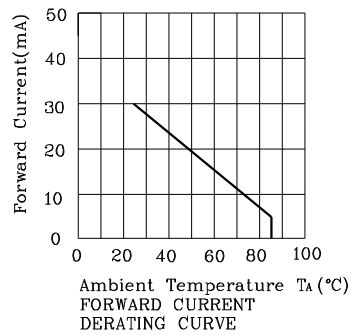
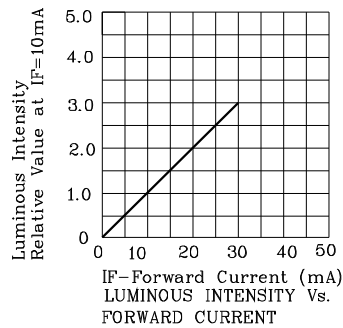
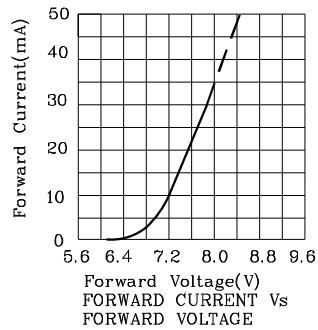

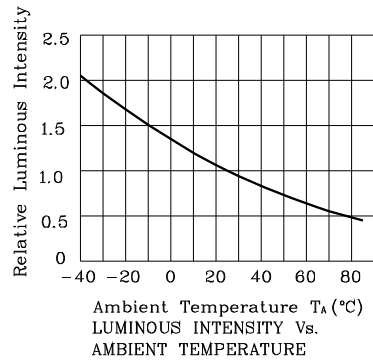
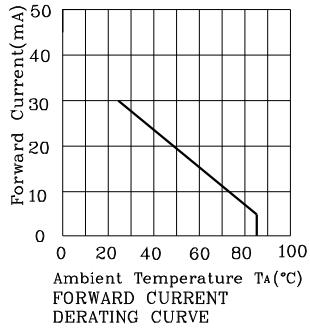
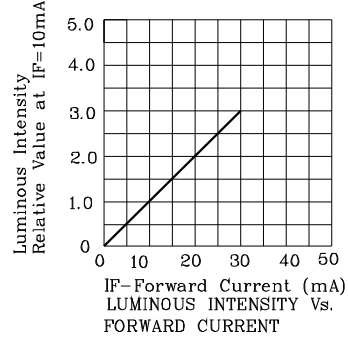
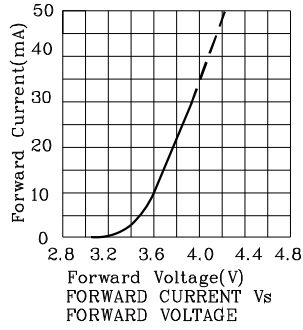

Wave Soldering Profile For Lead-free Through-hole LED.

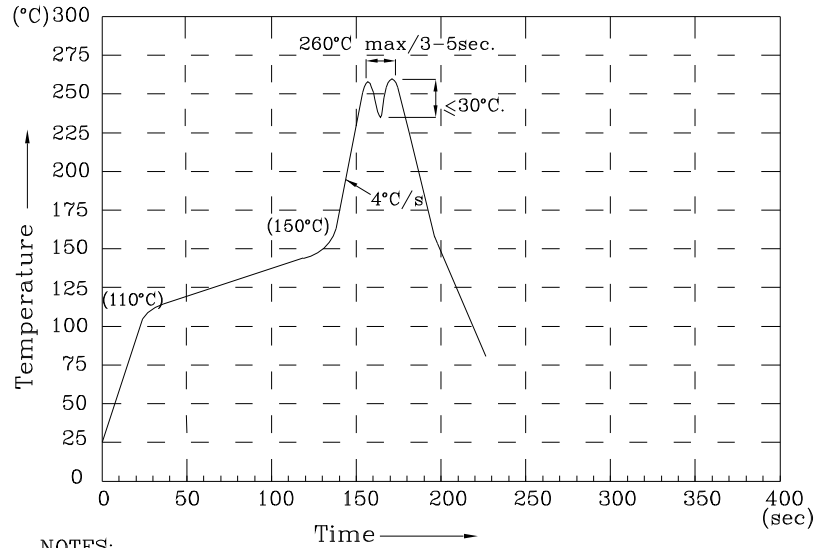

NOTES:

- 1.Recommend the wave temperature 245°C~260°C.The maximum soldering temperature should be less than 260°C.
- 2.Do not apply stress on epoxy resins when temperature is over 85 degree°C.
- 3.The soldering profile apply to the lead free soldering (Sn/Cu/Ag alloy).
- 4.No more than once.

Remarks:

If special sorting is required (e.g. binning based on forward voltage, Luminous intensity / luminous flux, or wavelength), the typical accuracy of the sorting process is as follows:

1. Wavelength: +/-1nm
2. Luminous intensity / luminous flux: +/-15%
3. Forward Voltage: +/-0.1V

Note: Accuracy may depend on the sorting parameters.

PACKING & LABEL SPECIFICATIONS

DMR57A

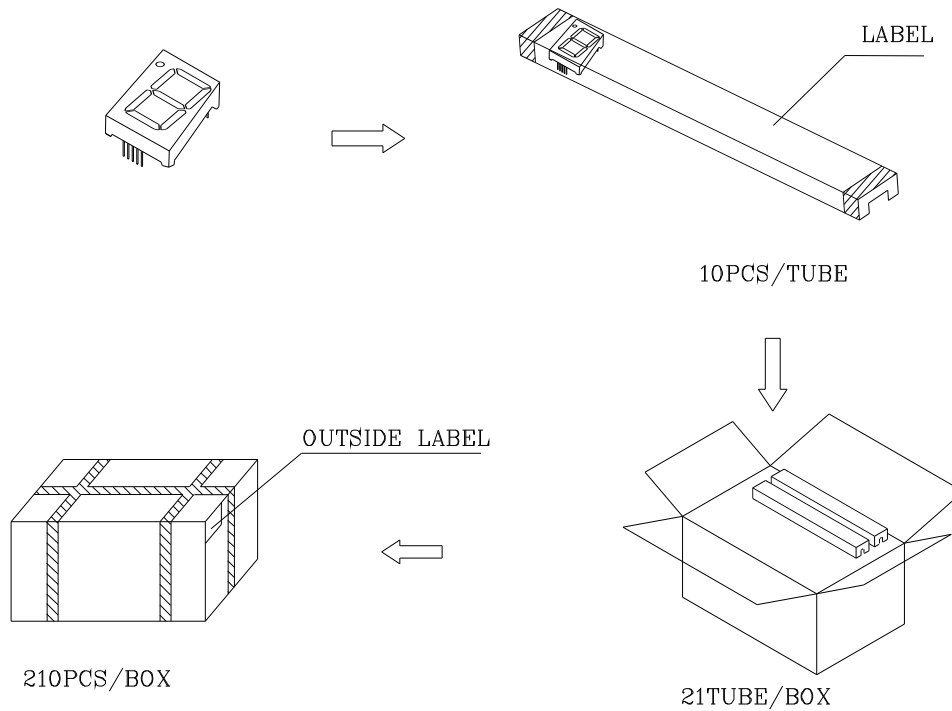

Inside LABEL Paste On The IC-tube

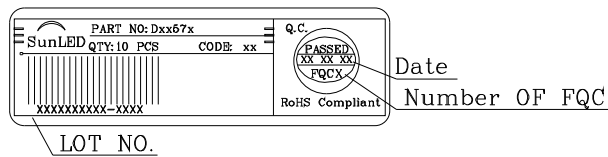

Outside LABEL Paste On The Box

