

Silicon NPN Power Transistors

2SC2792

DESCRIPTION

- With TO-3P(I) package
- High breakdown voltage
- Excellent switching times

APPLICATIONS

- Switching regulator and high voltage
- Switching applications
- High speed DC-DC converter applications

PINNING

PIN	DESCRIPTION
1	Base
2	Collector;connected to mounting base
3	Emitter

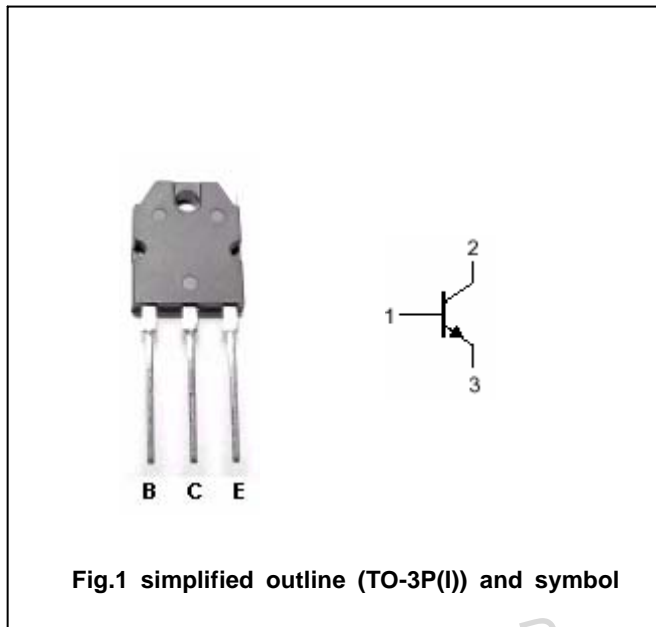

Absolute maximum ratings(Ta=25)

SYMBOL	PARAMETER	CONDITIONS	VALUE	UNIT
V _{CBO}	Collector-base voltage	Open emitter	850	V
V _{CEO}	Collector-emitter voltage	Open base	800	V
V _{EBO}	Emitter-base voltage	Open collector	7	V
I _C	Collector current-DC		2	A
I _{CM}	Collector current-peak		4	A
I _B	Base current		1	A
P _T	Total power dissipation	T _C =25	80	W
T _j	Junction temperature		150	
T _{stg}	Storage temperature		-55~150	

Silicon NPN Power Transistors

2SC2792

CHARACTERISTICS

T_j=25 unless otherwise specified

SYMBOL	PARAMETER	CONDITIONS	MIN	TYP.	MAX	UNIT
V _{(BR)CEO}	Collector-emitter breakdown voltage	I _C =10mA, I _B =0	800			V
V _{(BR)CBO}	Collector-base breakdown voltage	I _C =1mA, I _E =0	850			V
V _{CEsat}	Collector-emitter saturation voltage	I _C =500mA; I _B =50mA			1.0	V
V _{BEsat}	Base-emitter saturation voltage	I _C =500mA; I _B =50mA			1.5	V
I _{CBO}	Collector cut-off current	V _{CB} =800V; I _E =0			100	μA
I _{EBO}	Emitter cut-off current	V _{EB} =7V; I _C =0			1.0	mA
h _{FE}	DC current gain	I _C =0.5A; V _{CE} =5V	10			

Switching times

t _r	Rise time	V _{CC} =400V; 2I _{B1} =-I _{B2} =0.1A; R _L =800			1.0	μs
t _{stg}	Storage time				4.0	μs
t _f	Fall time				1.0	μs

Silicon NPN Power Transistors

2SC2792

PACKAGE OUTLINE

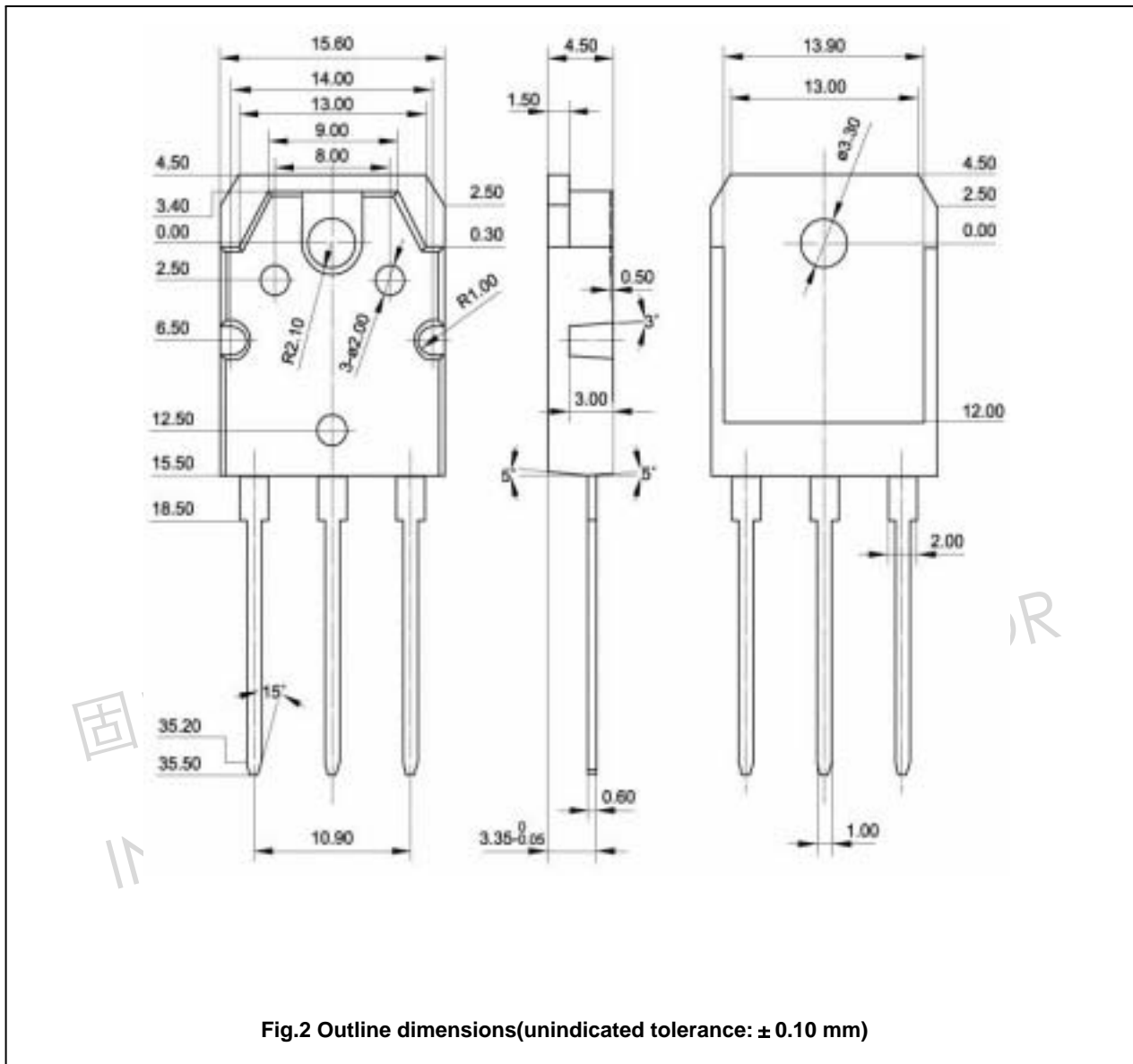

Silicon NPN Power Transistors

2SC2792

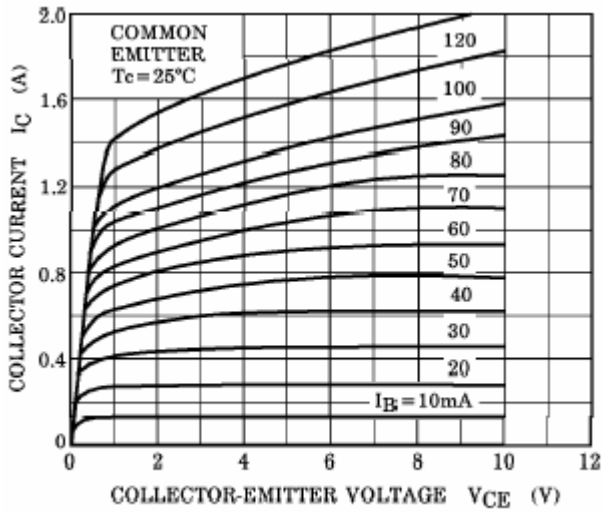

Fig.3 Static Characteristic

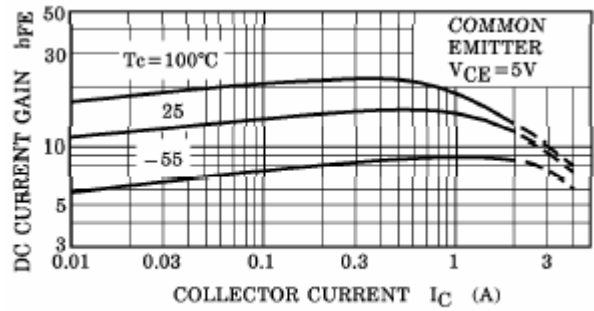

Fig.4 DC current Gain

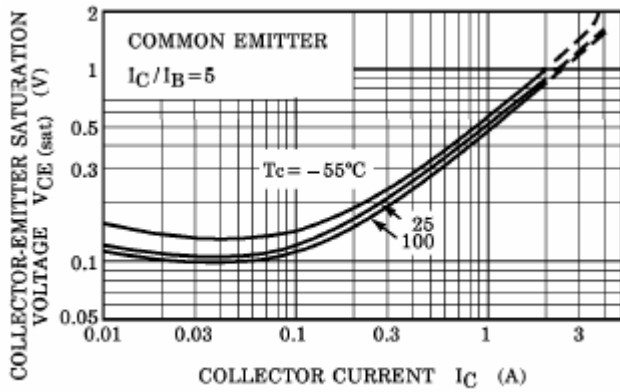

Fig.5 Collector-Emitter Saturation Voltage

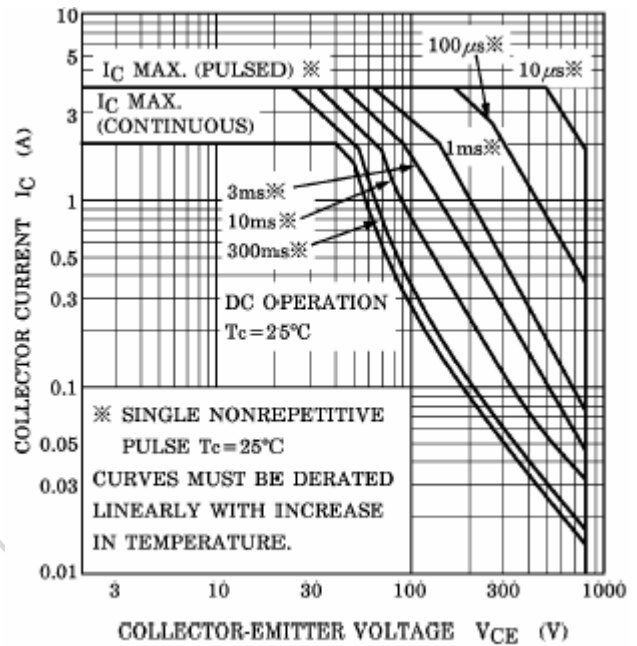

Fig.7 Safe Operating Area

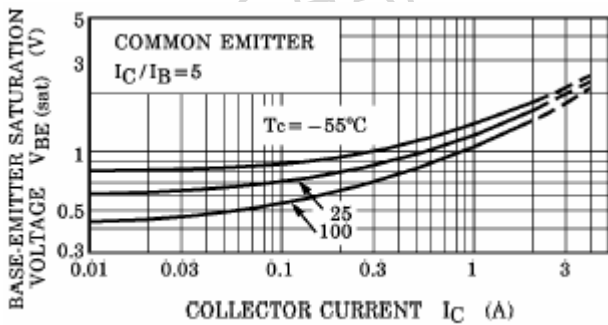

Fig.6 Base-Emitter Saturation Voltage