

# Three Phase Solid State Relays

**SIT865990**  
 24-520 VAC - 3 x 50A  
 (AC-51 : 3 x 22 ARMS)  
 (AC-53 : 3 x 12 ARMS)

- Solid State Relay for all type of loads with integrated heatsink
- DIN rail or panel mounting
- Back to back thyristors with TMS<sup>2</sup> technology
- 50A Thyristors size with  $I^2t > 1500A^2s$  (\*)
- 90-240VAC control voltage with input status LED
- RC+ Overvoltage protection by integrated VDR
- IP20
- Designed in conformity with UL, EN60950 and IEC60947-4-3
- No tool needed for mounting and dismounting or  
 DIN rail or direct mounting on panel

(\*) : on request : model with  $I^2t$  5000A<sup>2</sup>s up to 20000A<sup>2</sup>s

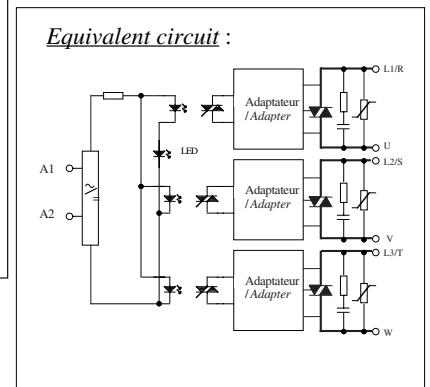
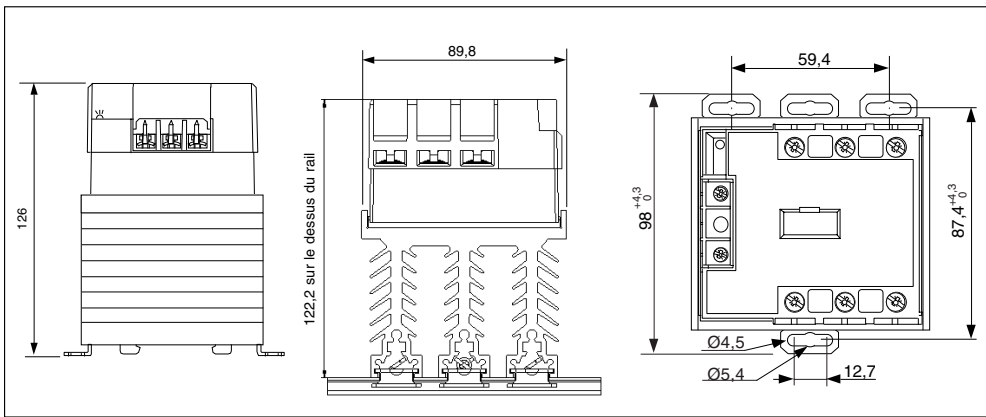
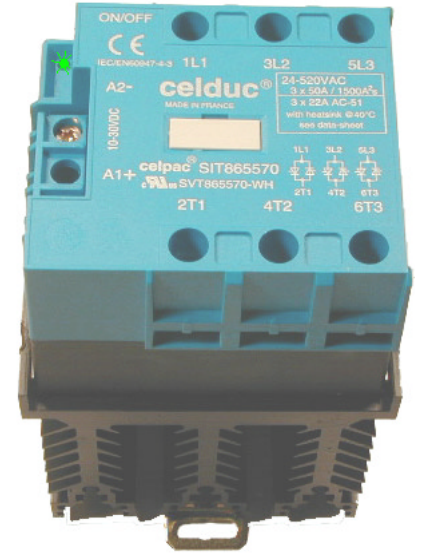

fig. 1 :Caractéristique d'entrée /

**Caractéristiques de commande (à 20°C) / Control characteristics (at 20°C)**

Paramètre / Parameter	Symbol	AC-DC			Unit
		Min	Nom	Max	
Tension de commande / Control voltage : DC	Uc	90		240	VDC
Tension de commande / Control voltage : AC	Uc	90		240	VAC
Courant de commande / Control current (@ Uc)	Ic	4,5		11	mA
Tension de relachement/Release voltage	Uc off	15			V
Résistance interne / Input internal resistor fig.1	Rc		21		KΩ
Tension inverse / Reverse voltage	Urv	polarity free			V

**Caractéristiques d'entrée-sortie (à 20°C) / Input-output characteristics (at 20°C)**

Isolement entrée-sortie/Input-output isolation @500m	Ui		4000		VRMS
Isolement sortie-semelle/Output-case isolation @500m	Ui		3300		VRMS
Tension assignée isolement/ Rated impulse voltage	Uimp		4000		V

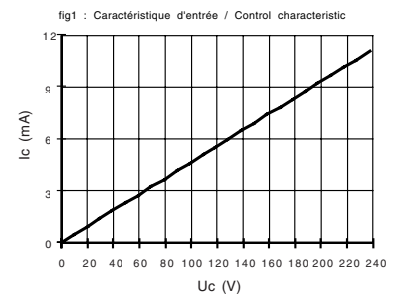

**General characteristics**

Parameter	Conditions	Symbol	Typ.	Unit
Poids/Weight			1000	g
Storage temperature range			-40 / +100	°C
Operating temperature range			-40 / +80	°C

Proud to serve you

**Output characteristics (at 20 °C)**

Parameter	Conditions	Symbol	Value	Unit
Load voltage		Ue	400	V rms
Minimum Operating range		Uemin	24	V rms
Maximum Operating range	( 480Vrms + 10% )	Uemax	520 (*)	V rms
Peak voltage		Up	1200 (*)	V
(*) Clamping voltage	by VDR	Uclamp	850	V
Synchronizing level		Usync	12	V
Latching voltage	Ie nom	Ua	10	V
AC-51 no permanent nominal current	( see Fig. 2 )	Ie AC-51	3x50	A rms
AC-51 nominal current	( see Fig. 2 )	Ie AC-51	3x22	A rms
AC-53 nominal current		Ie AC-53	3x12	A rms
Non repetitive overload current	tp=10ms (Fig. 3)	Itsm	550 (typ 720)	A
On state voltage drop	@ Ie nom	Vd	1,4	V
Off state leakage current	@Ue, 50Hz	Ilk	1	mA
Minimum load current		Ie min	5	mA
Turn on time	Uc nom DC ,f=50Hz	ton max	30	ms
Turn off time	Uc nom DC ,f=50Hz	toff max	30	ms
Operating frequency range		f	10-400	Hz
Off state dv/dt		dv/dt	500	V/μs
Maximum di/dt non repetitive		di/dt	50	A/μs
I2t (<10ms)		I2t	1500 (typ 2600)	A2s
Conducted immunity level in conformity with IEC 1000-4-4 (burst)	IEC 1000-4-4 (burst)		2kV criterion B	
Conducted immunity level in conformity with IEC 1000-4-5(schocks)	IEC 1000-4-5(schocks)		2kV criterion A	

**thermal curves :**

- curve 1 :**  
with ventilation in the heatsink (> 1m/s)
- curve 2 :**  
working in normal conditions with a small ventilation in the cabinet
- curve 3 :**  
according with IEC60947-4-2 in a closed cabinet without any ventilation.

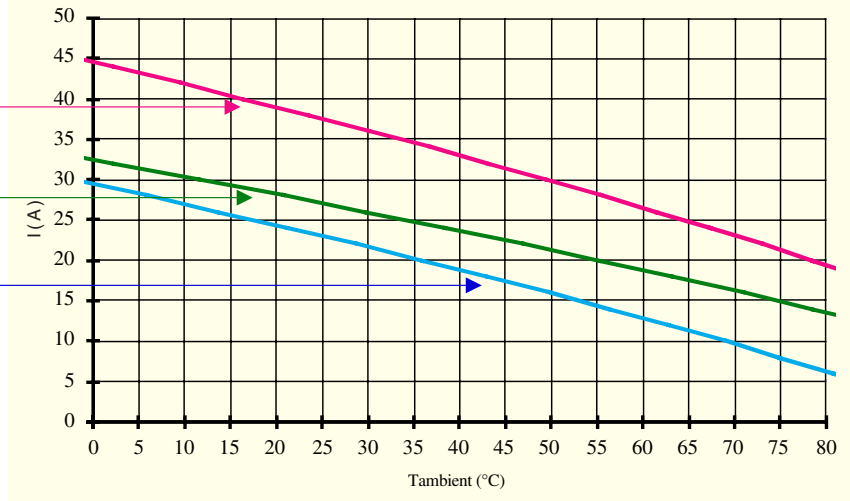
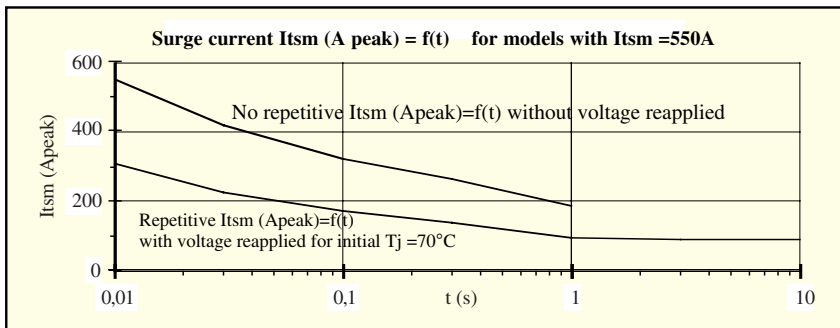

Fig.3 : Overload current curves







1 -No repetitive Itsm is given without voltage reapplied for the determination of the protection.  
2 -Repetitive Itsm is given for inrush current with initial Tj = 70°C. The repetition of the surge current decrease the lifetime SSR's .





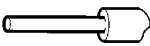

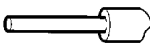
**Cautions :**

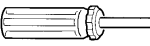
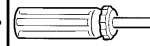
\* Semiconductor relays don't provide any galvanic insulation between the load and the mains.

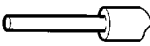
*Proud to serve you*

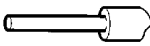

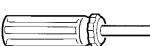
SVT						Wiring of the control circuit:	
NUMBER OF WIRES				SCREWDRIVER TYPE		MINIMUM TORQUE	
1		2					
SOLID (No ferrule)	FINE STRANDED (With ferrule)	SOLID (No ferrule)	FINE STRANDED (With ferrule)				
						N.m	
0,75 ... 2,5 mm <sup>2</sup>	0,75 ... 2,5 mm <sup>2</sup>	0,75 ... 2,5 mm <sup>2</sup>	0,75 ... 2,5 mm <sup>2</sup>	0,8 x 5,5 mm	POZIDRIV 2	1,2	

SVT						Wiring of the power circuit:	
NUMBER OF WIRES				SCREWDRIVER TYPE		MINIMUM TORQUE	
1		2					
SOLID (No ferrule)	FINE STRANDED (With ferrule)	SOLID (No ferrule)	FINE STRANDED (With ferrule)				
						N.m	
1,5 ... 10 mm <sup>2</sup>	1,5 ... 6 mm <sup>2</sup>	1,5 ... 10 mm <sup>2</sup>	1,5 ... 6 mm <sup>2</sup>	0,8 x 5,5 mm	POZIDRIV 2	1,8	

