

DC Film Capacitor MKT Radial Potted Type

Dimensions in millimeters

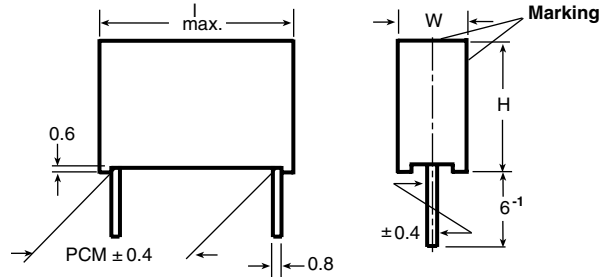

MAIN APPLICATIONS

Blocking, bypassing, filtering, timing, coupling and decoupling circuits, interference suppression in low voltage applications. High temperature operations. Automotive applications

REFERENCE STANDARDS

IEC 60384-2

MARKING

C-value; tolerance; rated voltage; manufacturer's type; code for dielectric material; manufacturer location; manufacturer's logo; year and week

DIELECTRIC

Polyester film

ELECTRODES

Metallized

CONSTRUCTION

Mono and series construction

RATED (DC) VOLTAGE

63 V, 100 V, 250 V, 400 V, 630 V, 1000 V

RATED (AC) VOLTAGE

40 V, 63 V, 160 V, 200 V, 220 V

FEATURES

10 mm to 27.5 mm lead pitch. Supplied loose in box, taped on reel
RoHS compliant



RoHS
COMPLIANT

ENCAPSULATION

Plastic case, epoxy resin sealed, flame retardant
UL-class 94 V-0

CLIMATIC TESTING CLASS ACC. TO IEC 60068-1

55/125/56

CAPACITANCE RANGE (E12 SERIES)

1000 pF to 15 μ F

CAPACITANCE TOLERANCE

20 %, \pm 10 %, \pm 5 %

LEADS

Tinned wire

MAXIMUM APPLICATION TEMPERATURE

125 °C

MAXIMUM OPERATING TEMPERATURE FOR LIMITED TIME

150 °C at 0.3 U_R for maximum 200 h

RELIABILITY

Operational life > 300 000 h (40 °C/0.5 x U_R)

Failure rate < 2 FIT (40 °C/0.5 x U_R)

DETAIL SPECIFICATION

For detailed data and test requirements contact:
dc-film@vishay.com

COMPOSITION OF CATALOG NUMBER

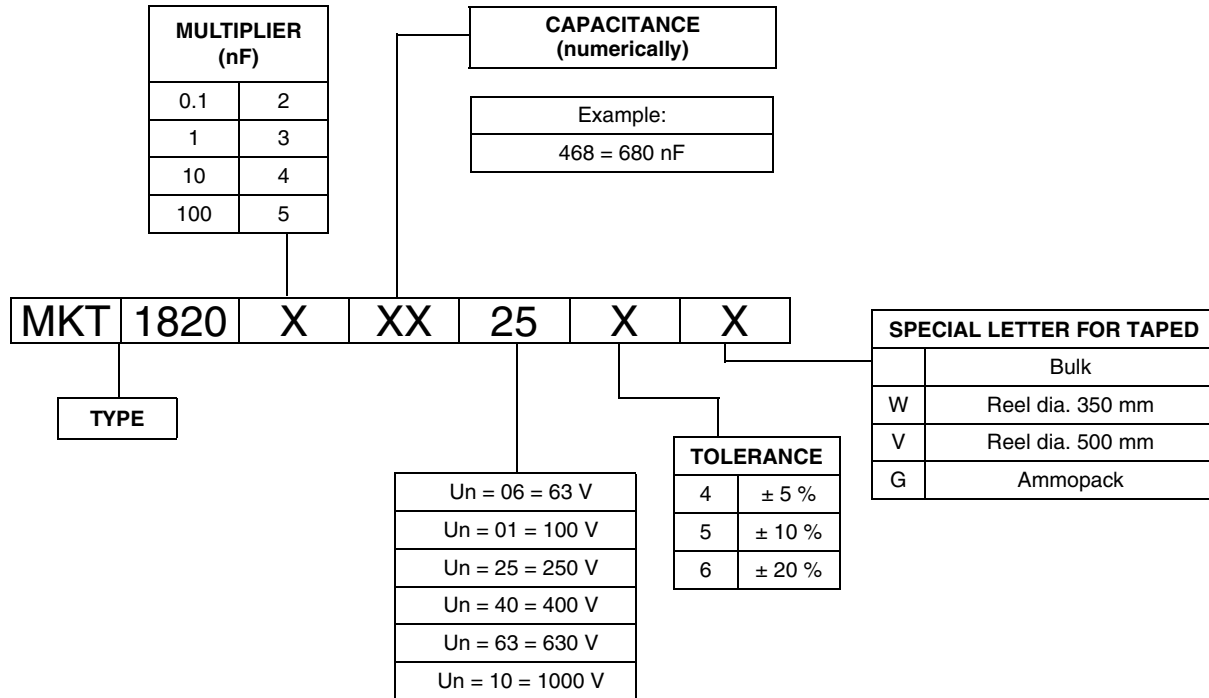

Note

For detailed tape specifications refer to "Packaging Information" www.vishay.com/docs?28139 or end of catalog

SPECIFIC REFERENCE DATA

DESCRIPTION		VALUE				
Tangent of loss angle:		at 1 kHz	at 10 kHz	at 100 kHz		
C x 0.1 μF		80 x 10 ⁻⁴	150 x 10 ⁻⁴	250 x 10 ⁻⁴		
0.1 μF ≤ C x 1.0 μF		80 x 10 ⁻⁴	150 x 10 ⁻⁴	-		
C ≥ 1.0 μF		100 x 10 ⁻⁴	-	-		
Pitch (mm)	Maximum pulse rise time (dU/dt) _R [V/μs]					
	63 Vdc	100 Vdc	250 Vdc	400 Vdc	630 Vdc	1000 Vdc
10	12	18	36	52	70	260
15	8	10	20	32	66	130
22.5	5	6	12	18	38	68
27.5	-	5	10	14	28	50
If the maximum pulse voltage is less than the rated voltage higher dU/dt values can be permitted.						
R between leads, for C ≤ 0.33 μF and U _R ≤ 100 V		> 15 000 MΩ				
R between leads, for C ≤ 0.33 μF and U _R > 100 V		> 30 000 MΩ				
RC between leads, for C > 0.33 μF and U _R ≤ 100 V		> 5000 s				
RC between leads, for C > 0.33 μF and U _R > 100 V		> 10 000 s				
R between leads and case, 100 V; (Foil Method)		> 30 000 MΩ				
Withstanding (DC) voltage (cut off current 10 mA); rise time 100 V/s		1.6 x U _{Rdc} , 1 min				
Withstanding (DC) leads and case		2 x U _{Rdc} , 1 min				
Maximum application temperature		125 °C				



DC Film Capacitor
MKT Radial Potted Type

Vishay Roederstein

CAPACITANCE	CAPACITANCE CODE	VOLTAGE CODE 06 63 Vdc/40 Vac				VOLTAGE CODE 01 100 Vdc/63 Vac				VOLTAGE CODE 25 250 Vdc/160 Vac			
		w (mm)	h (mm)	l (mm)	Pitch (mm)	w (mm)	h (mm)	l (mm)	Pitch (mm)	w (mm)	h (mm)	l (mm)	Pitch (mm)
d_t = 0.80 mm ± 0.8 mm													
1000 pF	-210	-	-	-	-	-	-	-	-	-	-	-	-
1500 pF	-215	-	-	-	-	-	-	-	-	-	-	-	-
2200 pF	-222	-	-	-	-	-	-	-	-	-	-	-	-
3300 pF	-233	-	-	-	-	-	-	-	-	-	-	-	-
4700 pF	-247	-	-	-	-	-	-	-	-	-	-	-	-
6800 pF	-268	-	-	-	-	-	-	-	-	-	-	-	-
0.01 µF	-310	-	-	-	-	-	-	-	-	-	-	-	-
0.015 µF	-315	-	-	-	-	-	-	-	-	-	-	-	-
0.022 µF	-322	-	-	-	-	-	-	-	-	3.5	8.0	13.0	10.0
0.033 µF	-333	-	-	-	-	-	-	-	-	3.5	8.0	13.0	10.0
0.047 µF	-347	-	-	-	-	-	-	-	-	3.5	8.0	13.0	10.0
0.068 µF	-368	-	-	-	-	3.5	8.0	13.0	10.0	3.5	8.0	13.0	10.0
0.10 µF	-410	-	-	-	-	3.5	8.0	13.0	10.0	4.5	9.5	13.0	10.0
0.15 µF	-415	-	-	-	-	3.5	8.0	13.0	10.0	5.5	10.5	13.0	10.0
0.22 µF	-422	3.5	8.0	13.0	10.0	3.5	8.0	13.0	10.0	6.5	11.5	13.0	10.0
0.33 µF	-433	3.5	8.0	13.0	10.0	4.0	9.0	13.0	10.0	5.5	10.5	18.0	15.0
0.47 µF	-447	3.5	8.0	13.0	10.0	4.5	9.5	13.0	10.0	6.5	12.5	18.0	15.0
0.68 µF	-468	4.0	9.0	13.0	10.0	5.5	10.5	13.0	10.0	7.5	13.5	18.0	15.0
1.0 µF	-510	4.5	9.5	13.0	10.0	5.5	10.5	18.0	15.0	8.5	14.5	18.0	15.0
1.5 µF	-515	5.5	10.5	13.0	10.0	6.5	12.5	18.0	15.0	8.5	16.5	26.5	22.5
2.2 µF	-522	6.5	11.5	13.0	10.0	6.5	12.5	18.0	15.0	10.5	18.5	26.5	22.5
3.3 µF	-533	6.5	12.5	18.0	15.0	8.5	14.5	18.0	15.0	12.5	20.0	26.5	22.5
4.7 µF	-547	7.5	13.5	18.0	15.0	7.5	15.5	26.5	22.5	13.5	23.5	31.5	27.5
6.8 µF	-568	8.5	14.5	18.0	15.0	8.5	16.5	26.5	22.5	-	-	-	-
10.0 µF	-610	8.5	17.5	18.0	15.0	10.5	18.5	26.5	22.5	-	-	-	-
15.0 µF	-615	8.5	16.5	26.5	22.5	11.5	20.5	31.5	27.5	-	-	-	-

CAPACITANCE	CAPACITANCE CODE	VOLTAGE CODE 40 400 Vdc/200 Vac				VOLTAGE CODE 63 630 Vdc/220 Vac				VOLTAGE CODE 10 1000 Vdc/220 Vac			
		w (mm)	h (mm)	l (mm)	Pitch (mm)	w (mm)	h (mm)	l (mm)	Pitch (mm)	w (mm)	h (mm)	l (mm)	Pitch (mm)
d_t = 0.80 mm ± 0.8 mm													
1000 pF	-210	-	-	-	-	3.5	8.0	13.0	10.0	4.0	9.0	13.0	10.0
1500 pF	-215	-	-	-	-	3.5	8.0	13.0	10.0	4.0	9.0	13.0	10.0
2200 pF	-222	-	-	-	-	3.5	8.0	13.0	10.0	4.0	9.0	13.0	10.0
3300 pF	-233	-	-	-	-	3.5	8.0	13.0	10.0	4.0	9.0	13.0	10.0
4700 pF	-247	-	-	-	-	3.5	8.0	13.0	10.0	5.5	10.5	13.0	10.0
6800 pF	-268	-	-	-	-	3.5	8.0	13.0	10.0	6.5	11.5	13.0	10.0
0.01 µF	-310	3.5	8.0	13.0	10.0	4.0	9.0	13.0	10.0	5.5	10.5	18.0	15.0
0.015 µF	-315	3.5	8.0	13.0	10.0	4.5	9.5	13.0	10.0	6.5	12.5	18.0	15.0
0.022 µF	-322	3.5	8.0	13.0	10.0	5.5	10.5	13.0	10.0	7.5	13.5	18.0	15.0
0.033 µF	-333	4.0	9.0	13.0	10.0	5.5	10.5	18	15.0	6.5	14.5	26.5	22.5
0.047 µF	-347	4.5	9.5	13.0	10.0	6.5	12.5	18	15.0	7.5	15.5	26.5	22.5
0.068 µF	-368	5.5	10.5	13.0	10.0	7.5	13.5	18	15.0	8.5	16.5	26.5	22.5
0.10 µF	-410	6.5	11.5	13.0	10.0	6.5	14.5	26.5	22.5	10.5	18.5	26.5	22.5
0.15 µF	-415	6.5	12.5	18.0	15.0	7.5	15.5	26.5	22.5	11.5	20.5	31.5	27.5
0.22 µF	-422	6.5	12.5	18.0	15.0	8.5	16.5	26.5	22.5	13.5	23.5	31.5	27.5
0.33 µF	-433	7.5	13.5	18.0	15.0	11.5	20.5	31.5	27.5	16.5	29.5	31.5	27.5
0.47 µF	-447	8.5	17.5	18.0	15.0	11.5	20.5	31.5	27.5	20.0	35.0	31.5	27.5
0.68 µF	-468	8.5	16.5	26.5	22.5	13.5	23.5	31.5	27.5	-	-	-	-
1.0 µF	-510	10.5	18.5	26.5	22.5	15.0	24.5	31.5	27.5	-	-	-	-
1.5 µF	-515	11.5	20.5	31.5	27.5	-	-	-	-	-	-	-	-
2.2 µF	-522	13.5	23.5	31.5	27.5	-	-	-	-	-	-	-	-
3.3 µF	-533	15.0	24.5	31.5	27.5	-	-	-	-	-	-	-	-
4.7 µF	-547	18.0	28.0	31.5	27.5	-	-	-	-	-	-	-	-

RECOMMENDED PACKAGING

PACKAGING CODE	TYPE OF PACKAGING	HEIGHT (H) (mm)	REEL DIAMETER	ORDERING CODE EXAMPLES	PITCH 10	PITCH 15	PITCH 22.5 TO 27.5
G	AMMO	18.5	S ⁽¹⁾	MKT 1820-410/405-G	x	x	-
W	REEL	18.5	350	MKT 1820-410/405-W	x	x	-
V	REEL	18.5	500	MKT 1820-422/635-V	-	x	x
G	AMMO	18.5	L ⁽²⁾	MKT 1820-422/635-G	-	-	x
-	BULK	-	-	MKT 1820-515/405	x	x	x

Note

⁽¹⁾ S = box size 55 x 210 x 340 mm (w x h x l)

⁽²⁾ L = box size 60 x 360 x 510 mm (w x h x l)

EXAMPLE OF ORDERING CODE

TYPE	CAPACITANCE CODE	VOLTAGE CODE	TOLERANCE CODE ⁽¹⁾	PACKAGING CODE
MKT 1820	410	06	5	G

Note

⁽¹⁾ **Tolerance Codes:** 4 = 5 % (J); 5 = 10 % (K); 6 = 20 % (M)

MOUNTING

NORMAL USE

The capacitors are designed for mounting on printed-circuit boards. The capacitors packed in bandoliers are designed for mounting on printed-circuit boards by means of automatic insertion machines.

For detailed tape specifications refer to "Packaging Information" www.vishay.com/docs?28139

SPECIFIC METHOD OF MOUNTING TO WITHSTAND VIBRATION AND SHOCK

In order to withstand vibration and shock tests, it must be ensured that the stand-off pips are in good contact with the printed-circuit board.

- For pitches ≤ 15 mm the capacitors shall be mechanically fixed by the leads
- For larger pitches the capacitors shall be mounted in the same way and the body clamped

SPACE REQUIREMENTS ON PRINTED-CIRCUIT BOARD

The maximum length and width of film capacitors is shown in the drawing:

- Eccentricity as in drawing. The maximum eccentricity is smaller than or equal to the lead diameter of the product concerned
- Product height with seating plane as given by "IEC 60717" as reference: $h_{max.} \leq h + 0.4$ mm or $h_{max.} \leq h' + 0.4$ mm

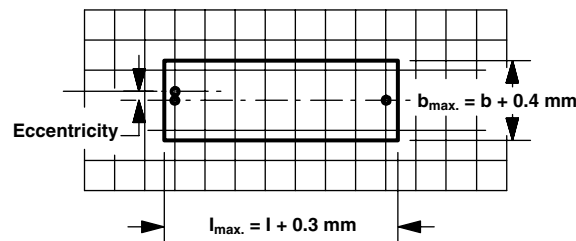

STORAGE TEMPERATURE

- Storage temperature: $T_{stg} = -25$ °C to $+40$ °C with RH maximum 80 % without condensation

RATINGS AND CHARACTERISTICS REFERENCE CONDITIONS

Unless otherwise specified, all electrical values apply to an ambient free temperature of 23 ± 1 °C, an atmospheric pressure of 86 kPa to 106 kPa and a relative humidity of 50 ± 2 %.

For reference testing, a conditioning period shall be applied over 96 ± 4 h by heating the products in a circulating air oven at the rated temperature and a relative humidity not exceeding 20 %.



CHARACTERISTICS

Permissible AC voltage vs. frequency at $T_{amb} \leq 85^\circ C$

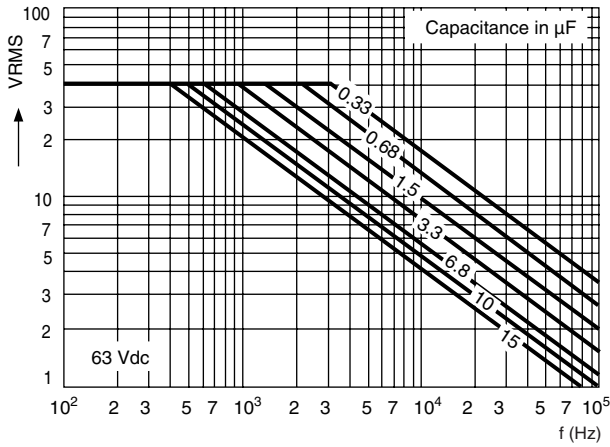

Permissible AC voltage vs. frequency at $T_{amb} \leq 85^\circ C$

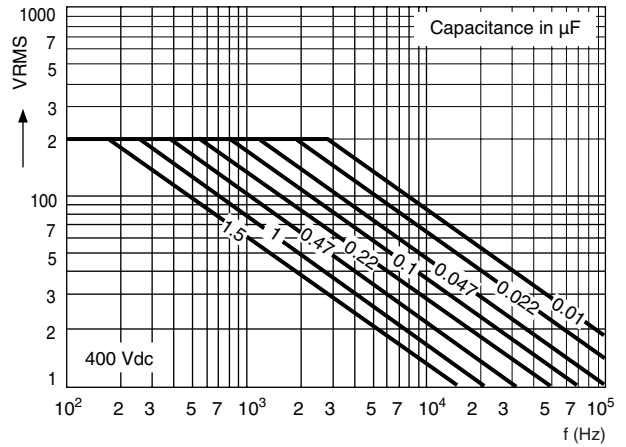

Permissible AC voltage vs. frequency at $T_{amb} \leq 85^\circ C$

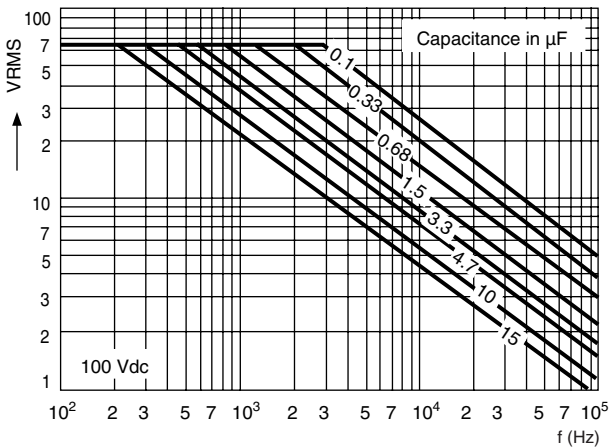

Permissible AC voltage vs. frequency at $T_{amb} \leq 85^\circ C$

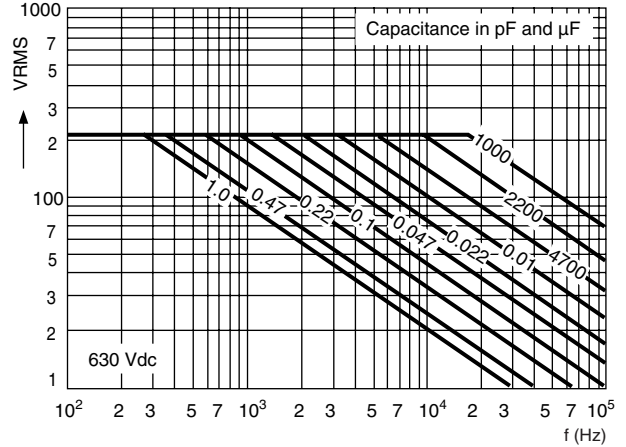

Permissible AC voltage vs. frequency at $T_{amb} \leq 85^\circ C$

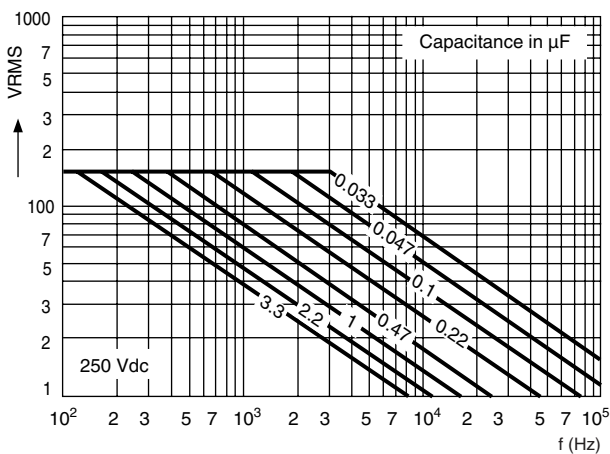

Permissible AC voltage vs. frequency at $T_{amb} \leq 85^\circ C$

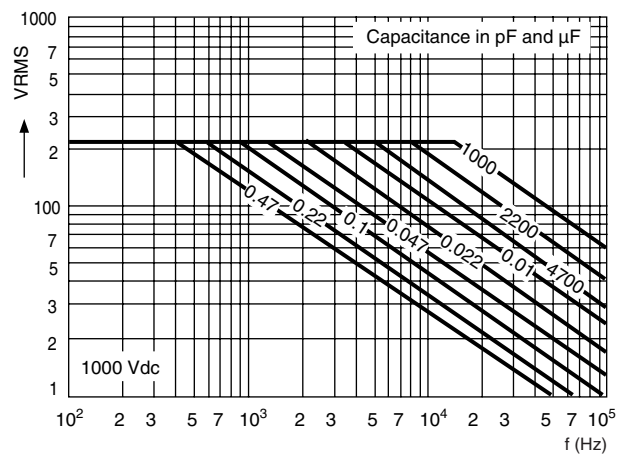

Nominal voltage (AC and DC) as a function of temperature
 $U = f(T_A), T_{LL} \leq T_A \leq T_{UL}$

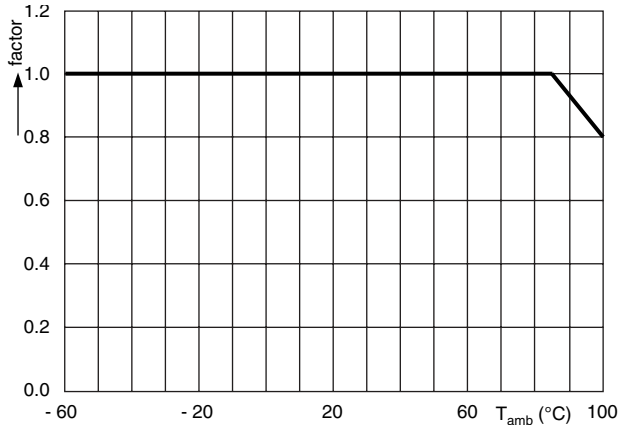

Capacitance as a function of temperature
 $\Delta C/C = f(T_A), T_{LL} \leq T_A \leq T_{UL}$

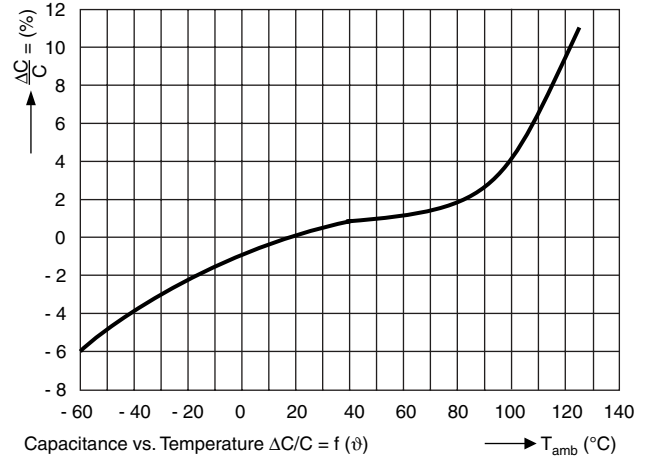

Capacitance as function of frequency
 $\Delta C/C = f(f), 100 \text{ Hz} \leq f \leq 1 \text{ MHz}$

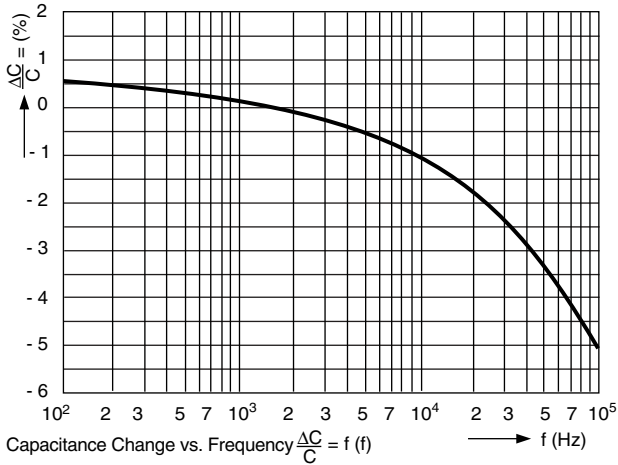

Dissipation factor as function of temperature
 $\Delta \tan \delta / \tan \delta = f(T_A), T_{LL} \leq T_A \leq T_{UL}$

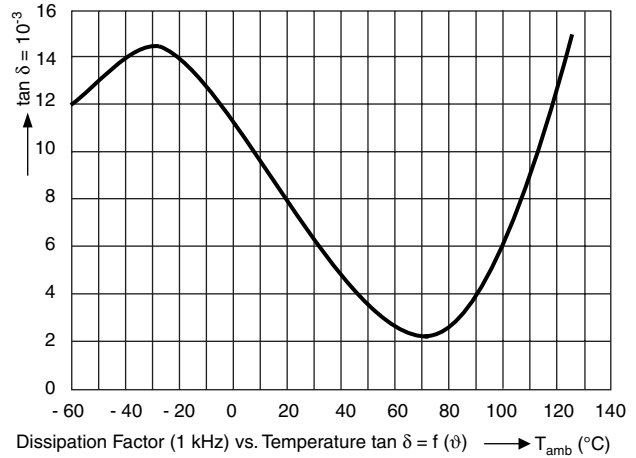

Insulation resistance as a function of temperature
 $R_{is} = f(T_A), T_{LL} \leq T_A \leq T_{UL}$

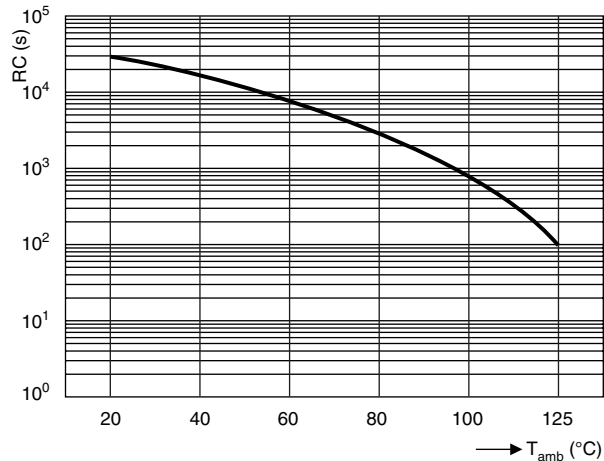

Dissipation factor as a function of frequency
 $\Delta \tan \delta / \tan \delta = f(f), 100 \text{ Hz} \leq f \leq 1 \text{ MHz}$

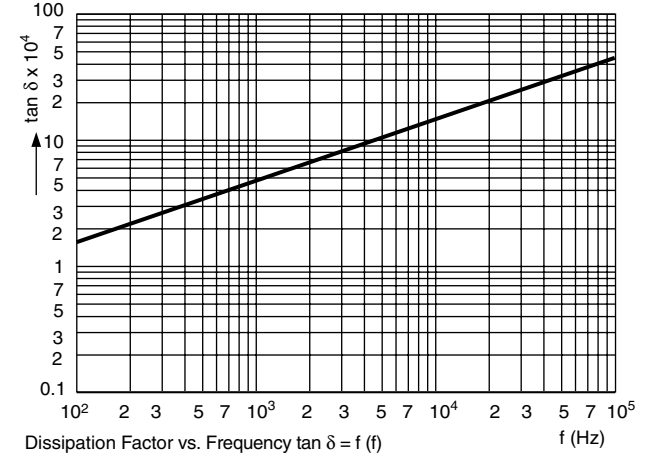

W _{max.} (mm)	HEAT CONDUCTIVITY (mW/°C)			
	PITCH 10.0 mm	PITCH 15.0 mm	PITCH 22.5 mm	PITCH 27.5 mm
3.5	5.0	-	-	-
4.0	6.0	-	-	-
4.5	6.5	-	-	-
5.5	8.0	10.0	-	-
6.5	9.5	12.5	19.0	-
7.5	-	14.5	22.0	-
8.5	-	16.0	24.0	-
10.5	-	-	29.0	-
11.5	-	-	-	37.5
12.5	-	-	33.5	-
13.5	-	-	-	44.5
15.0	-	-	-	48.5
16.5	-	-	-	58.0
18.0	-	-	-	58.5
20.0	-	-	-	73.0

POWER DISSIPATION AND MAXIMUM COMPONENT TEMPERATURE RISE

The power dissipation must be limited in order not to exceed the maximum allowed component temperature rise as a function of the free air ambient temperature.

The power dissipation can be calculated according type detail specification "HQN-384-01/101: Technical Information Film Capacitors" with the typical tgδ of the curves.

The component temperature rise (ΔT) can be measured (see section "Measuring the Component Temperature" for more details) or calculated by $\Delta T = P/G$:

- ΔT = Component temperature rise (°C)
- P = Power dissipation of the component (mW)
- G = Heat conductivity of the component (mW/°C)

MEASURING THE COMPONENT TEMPERATURE

A thermocouple must be attached to the capacitor body as in:

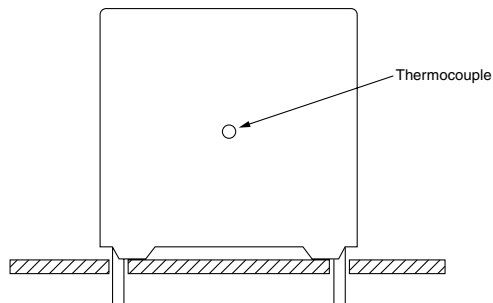

The temperature is measured in unloaded (T_{amb}) and maximum loaded condition (T_C).

The temperature rise is given by $\Delta T = T_C - T_{amb}$.

To avoid radiation or convection, the capacitor should be tested in a wind-free box.



APPLICATION NOTE AND LIMITING CONDITIONS

These capacitors are not suitable for mains applications as across-the-line capacitors without additional protection, as described hereunder. These mains applications are strictly regulated in safety standards and therefore electromagnetic interference suppression capacitors conforming the standards must be used.

To select the capacitor for a certain application, the following conditions must be checked:

1. The peak voltage (U_p) shall not be greater than the rated DC voltage (U_{Rdc})
2. The peak-to-peak voltage (U_{p-p}) shall not be greater than the maximum (U_{p-p}) to avoid the ionisation inception level
3. The voltage peak slope (dU/dt) shall not exceed the rated voltage pulse slope in an RC-circuit at rated voltage and without ringing. If the pulse voltage is lower than the rated DC voltage, the rated voltage pulse slope may be multiplied by U_{Rdc} and divided by the applied voltage.

For all other pulses following equation must be fulfilled:

$$2 \times \int_0^T \left(\frac{dU}{dt}\right)^2 \times dt < U_{Rdc} \times \left(\frac{dU}{dt}\right)_{rated}$$

T is the pulse duration

4. The maximum component surface temperature rise must be lower than the limits (see graph max. allowed component temperature rise).
5. Since in circuits used at voltages over 280 V peak-to-peak the risk for an intrinsically active flammability after a capacitor breakdown (short circuit) increases, it is recommended that the power to the component is limited to 100 times the values mentioned in the table: "Heat conductivity"
6. When using these capacitors as across-the-line capacitor in the input filter for mains applications or as series connected with an impedance to the mains the applicant must guarantee that the following conditions are fulfilled in any case (spikes and surge voltages from the mains included).

Voltage Conditions for 6 Above

ALLOWED VOLTAGES	$T_{amb} \leq 85 \text{ }^\circ\text{C}$	$85 \text{ }^\circ\text{C} < T_{amb} \leq 100 \text{ }^\circ\text{C}$	$100 \text{ }^\circ\text{C} < T_{amb} \leq 125 \text{ }^\circ\text{C}$
Maximum continuous RMS voltage	U_{Rac}	$0.8 \times U_{Rac}$	$0.5 \times U_{Rac}$
Maximum temperature RMS-overvoltage (< 24 h)	$1.25 \times U_{Rac}$	U_{Rac}	$0.6 \times U_{Rac}$
Maximum peak voltage (V_{O-P}) (< 2 s)	$1.6 \times U_{Rdc}$	$1.3 \times U_{Rdc}$	$0.5 \times U_{Rdc}$



DC Film Capacitor
MKT Radial Potted Type

Vishay Roederstein

INSPECTION REQUIREMENTS

General Notes:

Sub-clause numbers of tests and performance requirements refer to the “Sectional Specification, Publication IEC 60384-2 and Specific Reference Data”.

Group C Inspection Requirements

SUB-CLAUSE NUMBER AND TEST	CONDITIONS	PERFORMANCE REQUIREMENTS	
SUB-GROUP C1A PART OF SAMPLE OF SUB-GROUP C1			
4.1 Dimensions (detail)		As specified in chapter “General Data” of this specification	
4.3.1 Initial measurements	Capacitance Tangent of loss angle: For C ≤ 1 μF at 10 kHz For C > 1 μF at 1 kHz		
4.3 Robustness of terminations	Tensile and bending		No visible damage
4.4 Resistance to soldering heat	Method: 1A Solder bath: 280 °C ± 5 °C Duration: 5 s		
4.14 Component solvent resistance	Isopropylalcohol at room temperature Method: 2 Immersion time: 5 ± 0.5 min Recovery time: Min. 1 h, max. 2 h		No visible damage Legible marking $ \Delta C/C \leq 2\%$ of the value measured initially Increase of tan δ ≤ 0.003 for C ≤ 1 μF or ≤ 0.002 for C > 1 μF Compared to values measured in 4.3.1
4.4.2 Final measurements	Visual examination Capacitance Tangent of loss angle		
SUB-GROUP C1B PART OF SAMPLE OF SUB-GROUP C1			
4.6.1 Initial measurements	Capacitance Tangent of loss angle: For C ≤ 1 μF at 10 kHz For C > 1 μF at 1 kHz	No visible damage	
4.6 Rapid change of temperature	θA = - 55 °C θB = + 125 °C 5 cycles Duration t = 30 min		
4.7 Vibration	Visual examination Mounting: See section “Mounting” of this specification Procedure B4 Frequency range: 10 Hz to 55 Hz Amplitude: 0.75 mm or Acceleration 98 m/s ² (whichever is less severe) Total duration 6 h	No visible damage Legible marking	
4.7.2 Final inspection	Visual examination	No visible damage	
4.9 Shock	Mounting: See section “Mounting” for more information Pulse shape: Half sine Acceleration: 490 m/s ² Duration of pulse: 11 ms		



SUB-CLAUSE NUMBER AND TEST	CONDITIONS	PERFORMANCE REQUIREMENTS
SUB-GROUP C1B PART OF SAMPLE OF SUB-GROUP C1		
4.9.3 Final measurements	Visual examination Capacitance Tangent of loss angle Insulation resistance	No visible damage $ \Delta C/C \leq 5\%$ of the value measured in 4.6.1 Increase of $\tan \delta$ ≤ 0.003 for $C \leq 1 \mu\text{F}$ or ≤ 0.002 for $C > 1 \mu\text{F}$ Compared to values measured in 4.6.1 As specified in section "Insulation Resistance" of this specification
SUB-GROUP C1 COMBINED SAMPLE OF SPECIMENS OF SUB-GROUPS C1A AND C1B		
4.10 Climatic sequence 4.10.2 Dry heat 4.10.3 Damp heat cyclic Test Db, first cycle 4.10.4 Cold 4.10.6 Damp heat cyclic Test Db, remaining cycles 4.10.6.2 Final measurements	Temperature: + 125 °C Duration: 16 h Temperature: - 55 °C Duration: 2 h Voltage proof = U_{Rdc} for 1 min within 15 min after removal from testchamber Visual examination Capacitance Tangent of loss angle Insulation resistance	No breakdown or flashover No visible damage Legible marking $ \Delta C/C \leq 5\%$ of the value measured in 4.4.2 or 4.9.3 Increase of $\tan \delta$: ≤ 0.005 for $C \leq 1 \mu\text{F}$ or ≤ 0.003 for $C > 1 \mu\text{F}$ Compared to values measured in 4.3.1 or 4.6.1 $\geq 50\%$ of values specified in section "Insulation Resistance" of this specification
SUB-GROUP C2		
4.11 Damp heat steady state 4.11.1 Initial measurements 4.11.3 Final measurements	56 days; 40 °C; 90 % to 95 % RH Capacitance Tangent of loss angle at 1 kHz Voltage proof = U_{Rdc} for 1 min within 15 min after removal from testchamber Visual examination Capacitance Tangent of loss angle Insulation resistance	No breakdown or flashover No visible damage Legible marking $ \Delta C/C \leq 5\%$ of the value measured in 4.11.1. Increase of $\tan \delta \leq 0.005$ Compared to values measured in 4.11.1 $\geq 50\%$ of values specified in section "Insulation Resistance" of this specification



DC Film Capacitor
MKT Radial Potted Type

Vishay Roederstein

SUB-CLAUSE NUMBER AND TEST	CONDITIONS	PERFORMANCE REQUIREMENTS
SUB-GROUP C3		
4.12 Endurance 4.12.1 Initial measurements 4.12.5 Final measurements	Duration: 2000 h 1.25 x U _{Rdc} at 85 °C 1.0 x U _{Rdc} at 100 °C 0.6 U _{Rdc} at 125 °C Duration: 200 h 0.3 x U _{Rdc} at 150 °C Capacitance Tangent of loss angle: For C ≤ 1 μF at 10 kHz For C > 1 μF at 1 kHz Visual examination Capacitance Tangent of loss angle Insulation resistance	No visible damage Legible marking ΔC/C ≤ 5 % compared to values measured in 4.12.1 Increase of tan δ: ≤ 0.003 for C ≤ 1 μF or ≤ 0.002 for C > 1 μF Compared to values measured in 4.12.1 ≥ 50 % of values specified in section "Insulation Resistance" of this specification
SUB-GROUP C4		
4.13 Charge and discharge 4.13.1 Initial measurements 4.13.3 Final measurements	10 000 cycles Charged to U _{Rdc} Discharge resistance: $R = \frac{U_R}{C \times 5 \times (dU/dt)}$ Capacitance Tangent of loss angle: For C ≤ 1 μF at 10 kHz For C > 1 μF at 1 kHz Capacitance Insulation resistance	ΔC/C ≤ 3 % compared to values measured in 4.13.1 Increase of tan δ: ≤ 0.003 for C ≤ 1 μF or ≤ 0.002 for C > 1 μF Compared to values measured in 4.13.1 ≥ 50 % of values specified in section "Insulation Resistance" of this specification



Disclaimer

All product specifications and data are subject to change without notice.

Vishay Intertechnology, Inc., its affiliates, agents, and employees, and all persons acting on its or their behalf (collectively, "Vishay"), disclaim any and all liability for any errors, inaccuracies or incompleteness contained herein or in any other disclosure relating to any product.

Vishay disclaims any and all liability arising out of the use or application of any product described herein or of any information provided herein to the maximum extent permitted by law. The product specifications do not expand or otherwise modify Vishay's terms and conditions of purchase, including but not limited to the warranty expressed therein, which apply to these products.

No license, express or implied, by estoppel or otherwise, to any intellectual property rights is granted by this document or by any conduct of Vishay.

The products shown herein are not designed for use in medical, life-saving, or life-sustaining applications unless otherwise expressly indicated. Customers using or selling Vishay products not expressly indicated for use in such applications do so entirely at their own risk and agree to fully indemnify Vishay for any damages arising or resulting from such use or sale. Please contact authorized Vishay personnel to obtain written terms and conditions regarding products designed for such applications.

Product names and markings noted herein may be trademarks of their respective owners.