

FDB52N20

200V N-Channel MOSFET

Features

- 52A, 200V, $R_{DS(on)} = 0.049\Omega$ @ $V_{GS} = 10\text{ V}$
- Low gate charge (typical 49 nC)
- Low C_{rss} (typical 66 pF)
- Fast switching
- 100% avalanche tested
- Improved dv/dt capability

Description

These N-Channel enhancement mode power field effect transistors are produced using Fairchild's proprietary, planar stripe, DMOS technology.

This advanced technology has been especially tailored to minimize on-state resistance, provide superior switching performance, and withstand high energy pulse in the avalanche and commutation mode. These devices are well suited for high efficient switched mode power supplies and active power factor correction.

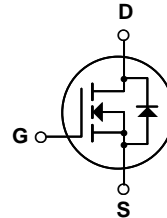
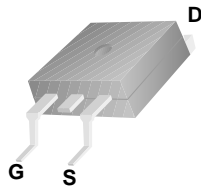

Absolute Maximum Ratings

Symbol	Parameter	FDB52N20	Unit
V_{DSS}	Drain-Source Voltage	200	V
I_D	Drain Current	- Continuous ($T_C = 25^\circ\text{C}$)	52
		- Continuous ($T_C = 100^\circ\text{C}$)	33
I_{DM}	Drain Current - Pulsed (Note 1)	208	A
V_{GSS}	Gate-Source voltage	± 30	V
E_{AS}	Single Pulsed Avalanche Energy (Note 2)	2520	mJ
I_{AR}	Avalanche Current (Note 1)	52	A
E_{AR}	Repetitive Avalanche Energy (Note 1)	35.7	mJ
dv/dt	Peak Diode Recovery dv/dt (Note 3)	4.5	V/ns
P_D	Power Dissipation ($T_C = 25^\circ\text{C}$)	- Derate above 25°C	357
			2.86
T_J, T_{STG}	Operating and Storage Temperature Range	-55 to +150	$^\circ\text{C}$
T_L	Maximum Lead Temperature for Soldering Purpose, 1/8" from Case for 5 Seconds	300	$^\circ\text{C}$

Thermal Characteristics

Symbol	Parameter	Min.	Max.	Unit
$R_{\theta JC}$	Thermal Resistance, Junction-to-Case	--	0.35	$^\circ\text{C}/\text{W}$
$R_{\theta JA}^*$	Thermal Resistance, Junction-to-Ambient*	--	40	$^\circ\text{C}/\text{W}$
$R_{\theta JA}$	Thermal Resistance, Junction-to-Ambient	--	62.5	$^\circ\text{C}/\text{W}$

* When mounted on the minimum pad size recommended (PCB Mount)

Package Marking and Ordering Information

Device Marking	Device	Package	Reel Size	Tape Width	Quantity
FDB52N20	FDB52N20TM	D ² -PAK	330mm	24mm	800

Electrical Characteristics T_C = 25°C unless otherwise noted

Symbol	Parameter	Conditions	Min.	Typ.	Max	Units
Off Characteristics						
BV _{DSS}	Drain-Source Breakdown Voltage	V _{GS} = 0V, I _D = 250μA	200	--	--	V
ΔBV _{DSS} / ΔT _J	Breakdown Voltage Temperature Coefficient	I _D = 250μA, Referenced to 25°C	--	0.2	--	V/°C
I _{DSS}	Zero Gate Voltage Drain Current	V _{DS} = 200V, V _{GS} = 0V V _{DS} = 160V, T _C = 125°C	--	--	1 10	μA μA
I _{GSSF}	Gate-Body Leakage Current, Forward	V _{GS} = 30V, V _{DS} = 0V	--	--	100	nA
I _{GSSR}	Gate-Body Leakage Current, Reverse	V _{GS} = -30V, V _{DS} = 0V	--	--	-100	nA
On Characteristics						
V _{GS(th)}	Gate Threshold Voltage	V _{DS} = V _{GS} , I _D = 250μA	3.0	--	5.0	V
R _{DS(on)}	Static Drain-Source On-Resistance	V _{GS} = 10V, I _D = 26A	--	0.041	0.049	Ω
g _{FS}	Forward Transconductance	V _{DS} = 40V, I _D = 26A (Note 4)	--	35	--	S
Dynamic Characteristics						
C _{iss}	Input Capacitance	V _{DS} = 25V, V _{GS} = 0V, f = 1.0MHz	--	2230	2900	pF
C _{oss}	Output Capacitance		--	540	700	pF
C _{rss}	Reverse Transfer Capacitance		--	66	100	pF
Switching Characteristics						
t _{d(on)}	Turn-On Delay Time	V _{DD} = 100V, I _D = 52A R _G = 25Ω (Note 4, 5)	--	53	115	ns
t _r	Turn-On Rise Time		--	175	359	ns
t _{d(off)}	Turn-Off Delay Time		--	48	107	ns
t _f	Turn-Off Fall Time		--	29	68	ns
Q _g	Total Gate Charge	V _{DS} = 160V, I _D = 52A V _{GS} = 10V (Note 4, 5)	--	49	63	nC
Q _{gs}	Gate-Source Charge		--	19	--	nC
Q _{gd}	Gate-Drain Charge		--	24	--	nC
Drain-Source Diode Characteristics and Maximum Ratings						
I _S	Maximum Continuous Drain-Source Diode Forward Current		--	--	52	A
I _{SM}	Maximum Pulsed Drain-Source Diode Forward Current		--	--	204	A
V _{SD}	Drain-Source Diode Forward Voltage	V _{GS} = 0V, I _S = 52A	--	--	1.4	V
t _{rr}	Reverse Recovery Time	V _{GS} = 0V, I _S = 52A di _F /dt = 100A/μs (Note 4)	--	162	--	ns
Q _{rr}	Reverse Recovery Charge		--	1.3	--	μC

NOTES:

1. Repetitive Rating: Pulse width limited by maximum junction temperature
2. L = 1.4mH, I_{AS} = 52A, V_{DD} = 50V, R_G = 25Ω, Starting T_J = 25°C
3. I_{SD} ≤ 52A, di/dt ≤ 200A/μs, V_{DD} ≤ BV_{DSS}, Starting T_J = 25°C
4. Pulse Test: Pulse width ≤ 300μs, Duty Cycle ≤ 2%
5. Essentially Independent of Operating Temperature Typical Characteristics

Typical Performance Characteristics

Figure 1. On-Region Characteristics

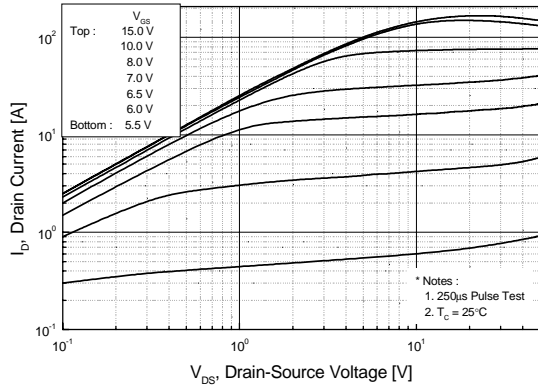

Figure 2. Transfer Characteristics

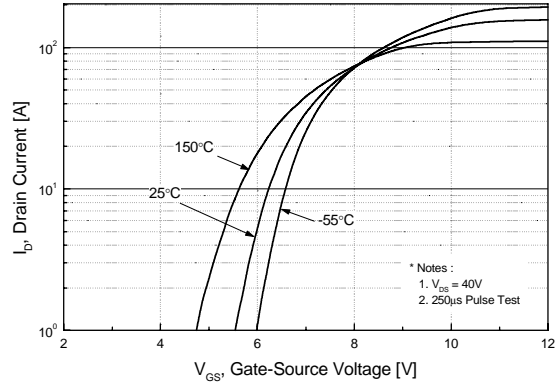

Figure 3. On-Resistance Variation vs. Drain Current and Gate Voltage

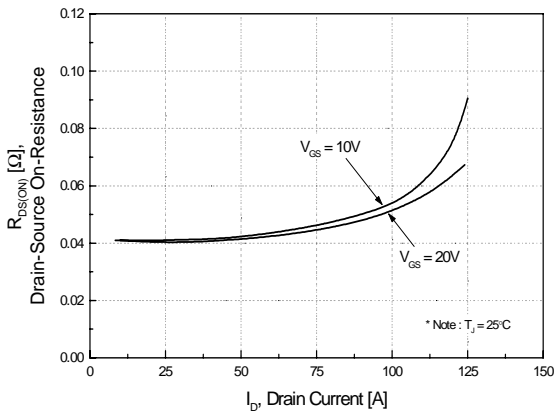

Figure 4. Body Diode Forward Voltage Variation vs. Source Current and Temperature

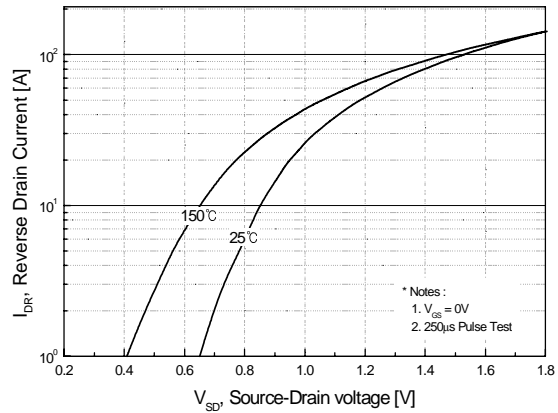

Figure 5. Capacitance Characteristics

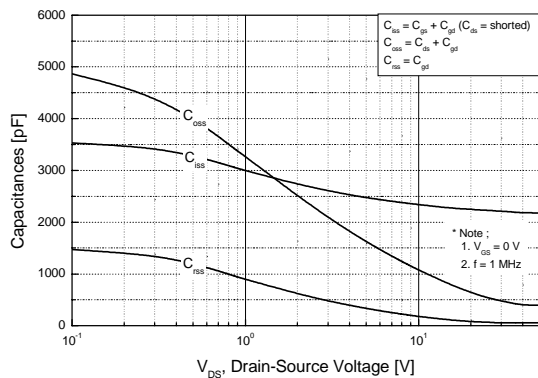
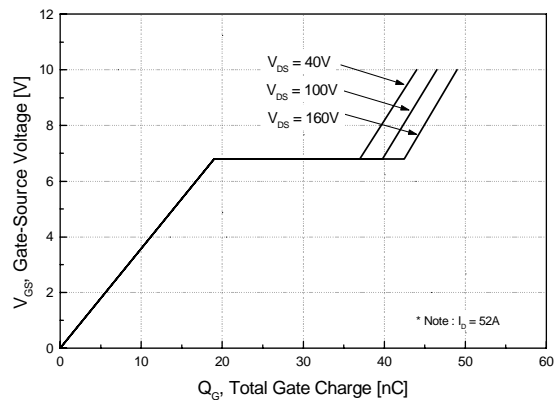

Figure 6. Gate Charge Characteristics



Typical Performance Characteristics (Continued)

Figure 7. Breakdown Voltage Variation vs. Temperature

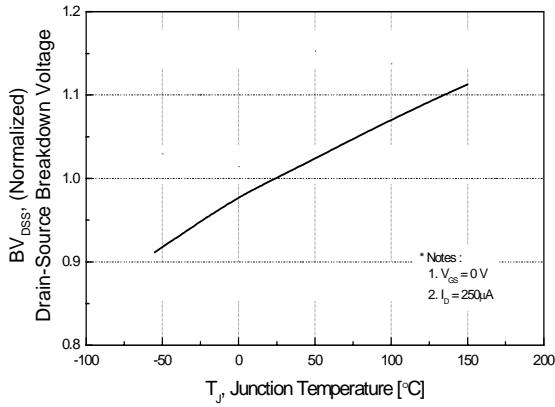

Figure 8. On-Resistance Variation vs. Temperature

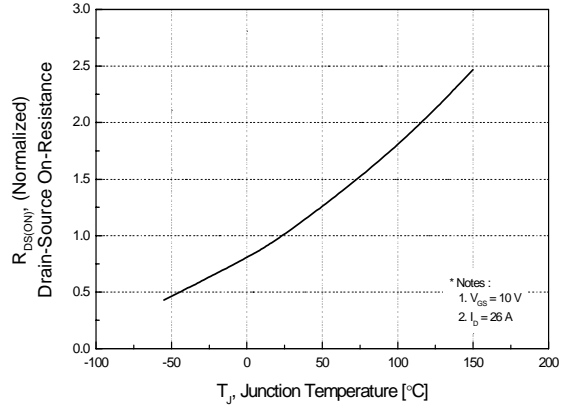

Figure 9. Maximum Safe Operating Area

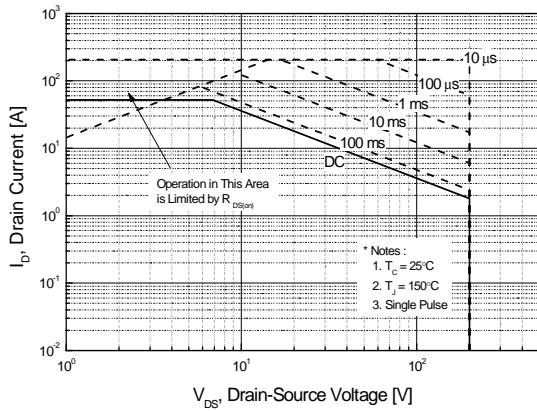

Figure 10. Maximum Drain Current vs. Case Temperature

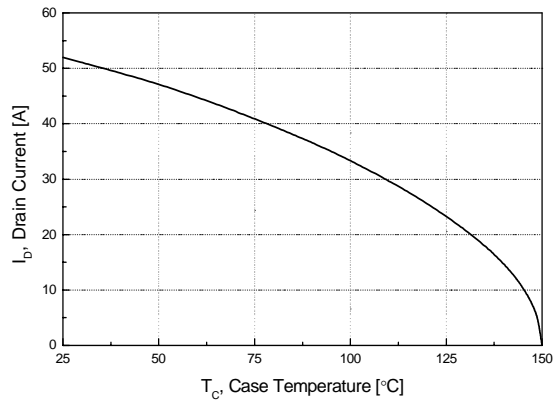
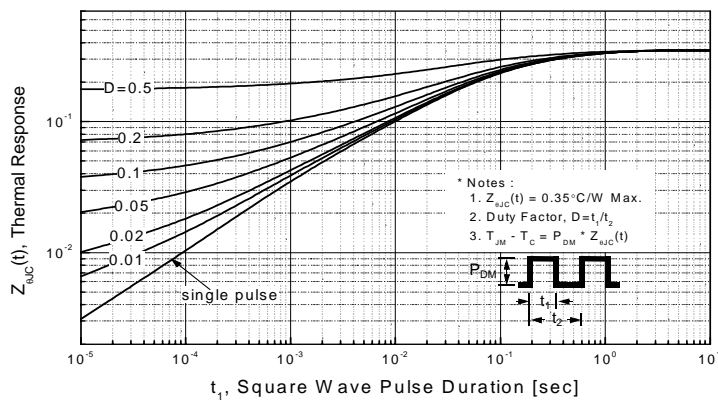
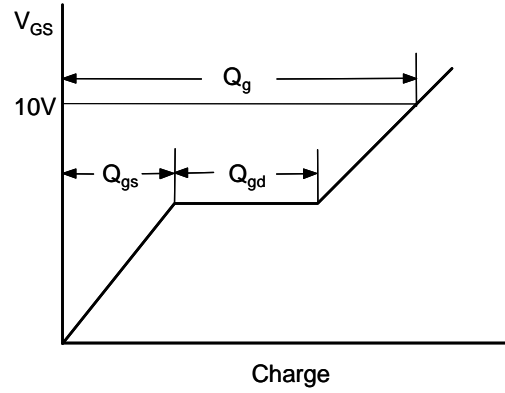
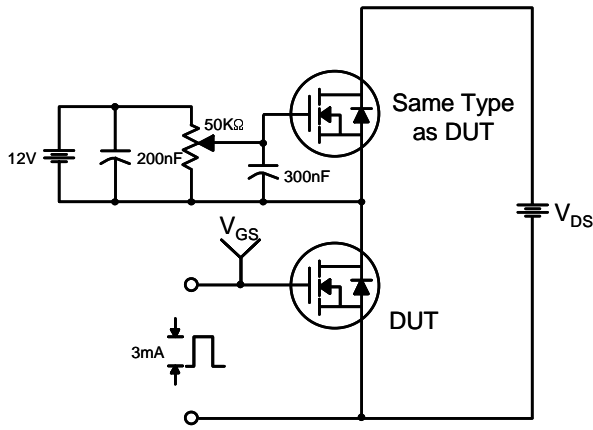

Figure 11. Transient Thermal Response Curve



Gate Charge Test Circuit & Waveform



Resistive Switching Test Circuit & Waveforms

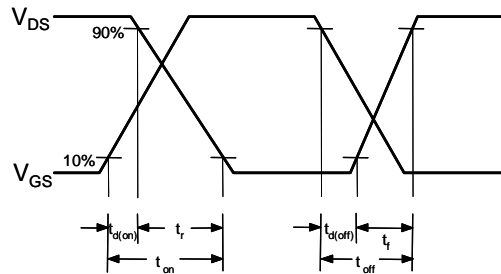
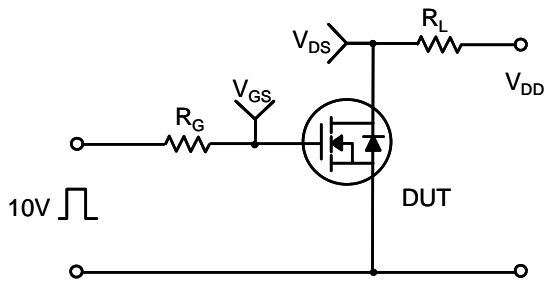

Unclamped Inductive Switching Test Circuit & Waveforms

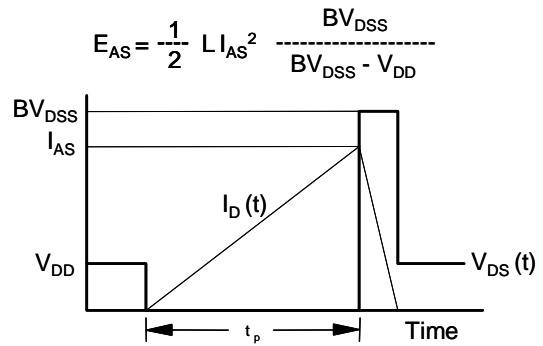
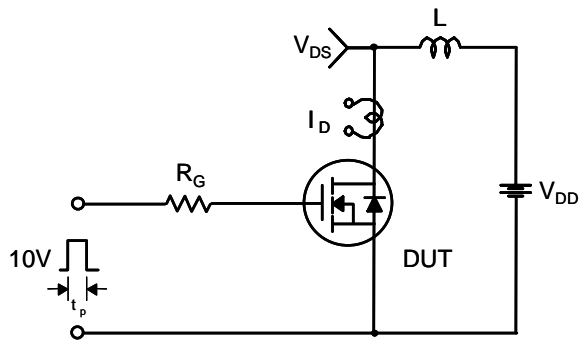

Peak Diode Recovery dv/dt Test Circuit & Waveforms

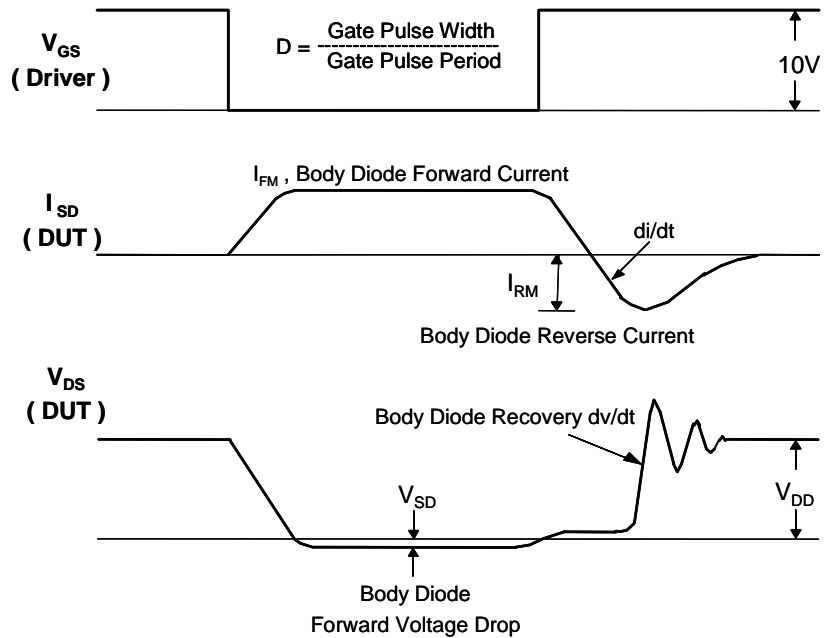
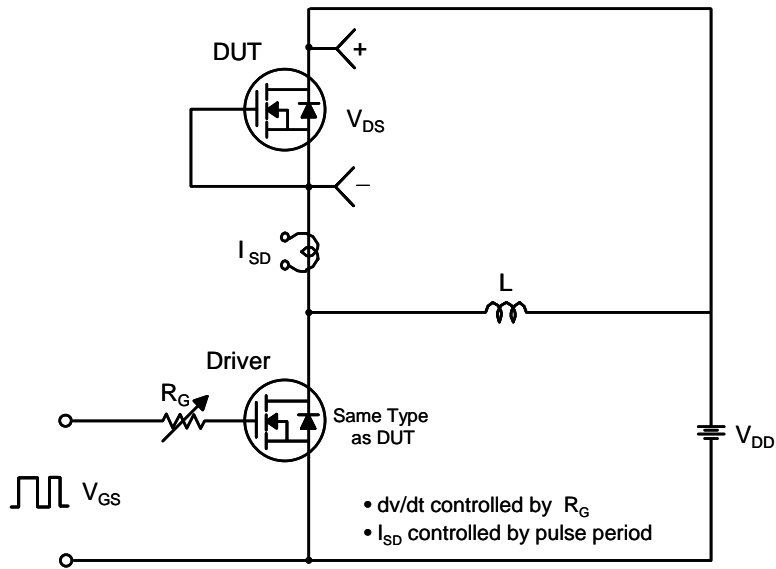

Mechanical Dimensions

D2-PAK

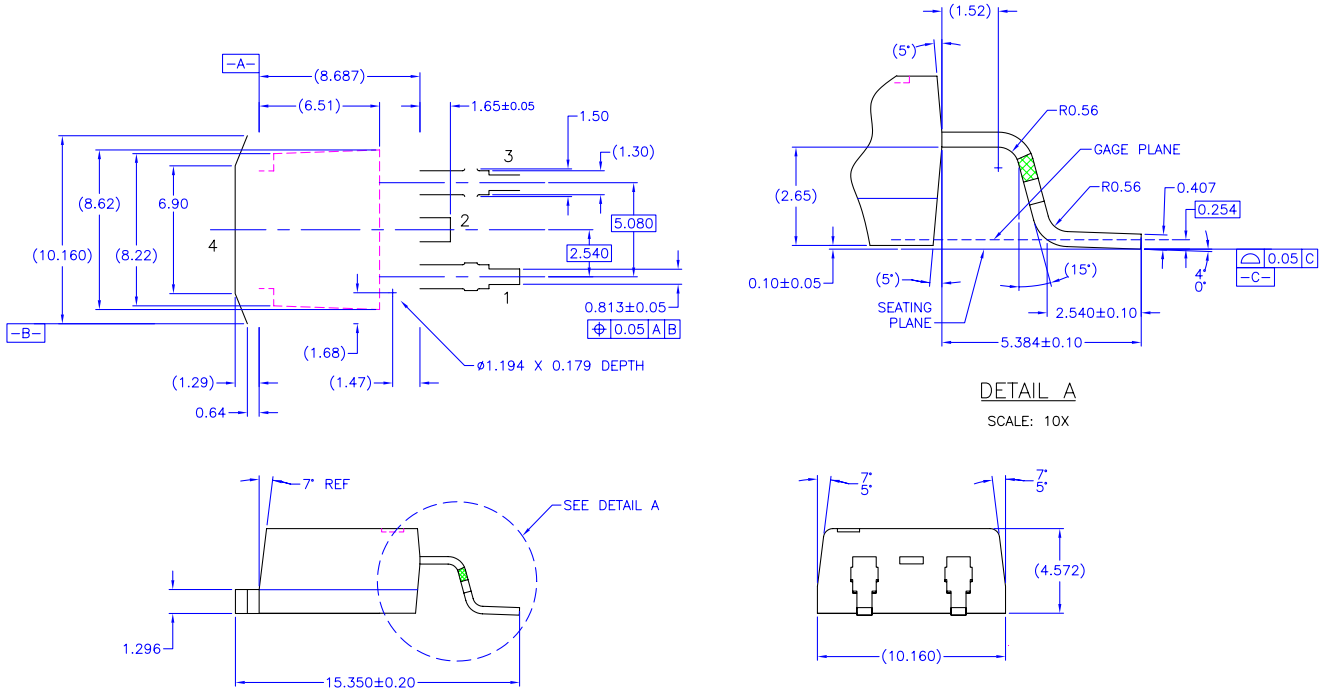





NOTES: UNLESS OTHERWISE SPECIFIED

- A) STANDARD LEAD FINISH: 200 MICROINCHES / 5.08 MICROMETERS MIN. 85Sn15Pb / MATTE Sn (LEAD FREE) ON LEADFRAME MATERIAL.
- B) MAXIMUM VERTICAL BURR ON LEAD TIPS NOT TO EXCEED 0.05MM FACING UP. VERTICAL LEAD TIP BURR DOWN SHOULD BE ZERO.
- C) NO PACKAGE CHIPS, CRACKS OR SURFACE INDENTATION ALLOWED AFTER FORMING.
- D) DOCUMENT REFERENCE:
 LEADFRAME: (CB)36-0270, TO-263, 3 LDS, SUZHOU, L-BEND, IDF
 MOLDED PACKAGE: (CB)41-0100, TO-263, 3 LDS, SUZHOU, IDF



TRADEMARKS

The following includes registered and unregistered trademarks and service marks, owned by Fairchild Semiconductor and/or its global subsidiaries, and is not intended to be an exhaustive list of all such trademarks.

- | | | | |
|---|---|---|---|
| Build it Now™ | FPST™ | PDP SPM™ | The Power Franchise® |
| CorePLUSTM | F-PFST™ | Power-SPM™ | the power franchise |
| CorePOWER™ | FRFET® | PowerTrench® | TinyBoost™ |
| CROSSVOLT™ | Global Power ResourceSM | Programmable Active Droop™ | TinyBuck™ |
| CTL™ | Green FPS™ | QFET® | TinyLogic® |
| Current Transfer Logic™ | Green FPS™ e-Series™ | QST™ | TINYOPTO™ |
| EcoSPARK® | GTO™ | Quiet Series™ | TinyPower™ |
| EfficientMax™ | IntelliMAX™ | RapidConfigure™ | TinyPWM™ |
| EZSWITCH™ * | ISOPLANAR™ | Saving our world, 1mW at a time™ | TinyWire™ |
|  | MegaBuck™ | SmartMax™ |  |
|  | MICROCOUPLER™ | SMART START™ | UHC® |
| Fairchild® | MicroFET™ | SPM® | Ultra FRFET™ |
| Fairchild Semiconductor® | MicroPak™ | STEALTH™ | UniFET™ |
| FACT Quiet Series™ | MillerDrive™ | SuperFET™ | VCX™ |
| FACT® | MotionMax™ | SuperSOT™-3 | VisualMax™ |
| FAST® | Motion-SPM™ | SuperSOT™-6 | |
| FastvCore™ | OPTOLOGIC® | SuperSOT™-8 | |
| FlashWriter® * | OPTOPLANAR® | SuperMOS™ | |
| |  | SyncFET™ | |
| | |  | |

* EZSWITCH™ and FlashWriter® are trademarks of System General Corporation, used under license by Fairchild Semiconductor.

DISCLAIMER

FAIRCHILD SEMICONDUCTOR RESERVES THE RIGHT TO MAKE CHANGES WITHOUT FURTHER NOTICE TO ANY PRODUCTS HEREIN TO IMPROVE RELIABILITY, FUNCTION, OR DESIGN. FAIRCHILD DOES NOT ASSUME ANY LIABILITY ARISING OUT OF THE APPLICATION OR USE OF ANY PRODUCT OR CIRCUIT DESCRIBED HEREIN; NEITHER DOES IT CONVEY ANY LICENSE UNDER ITS PATENT RIGHTS, NOR THE RIGHTS OF OTHERS. THESE SPECIFICATIONS DO NOT EXPAND THE TERMS OF FAIRCHILD'S WORLDWIDE TERMS AND CONDITIONS, SPECIFICALLY THE WARRANTY THEREIN, WHICH COVERS THESE PRODUCTS.

LIFE SUPPORT POLICY

FAIRCHILD'S PRODUCTS ARE NOT AUTHORIZED FOR USE AS CRITICAL COMPONENTS IN LIFE SUPPORT DEVICES OR SYSTEMS WITHOUT THE EXPRESS WRITTEN APPROVAL OF FAIRCHILD SEMICONDUCTOR CORPORATION.

As used herein:

- Life support devices or systems are devices or systems which, (a) are intended for surgical implant into the body or (b) support or sustain life, and (c) whose failure to perform when properly used in accordance with instructions for use provided in the labeling, can be reasonably expected to result in a significant injury of the user.
- A critical component in any component of a life support, device, or system whose failure to perform can be reasonably expected to cause the failure of the life support device or system, or to affect its safety or effectiveness.

ANTI-COUNTERFEITING POLICY

Fairchild Semiconductor Corporation's Anti-Counterfeiting Policy. Fairchild's Anti-Counterfeiting Policy is also stated on our external website, www.fairchildsemi.com, under Sales Support.

Counterfeiting of semiconductor parts is a growing problem in the industry. All manufactures of semiconductor products are experiencing counterfeiting of their parts. Customers who inadvertently purchase counterfeit parts experience many problems such as loss of brand reputation, substandard performance, failed application, and increased cost of production and manufacturing delays. Fairchild is taking strong measures to protect ourselves and our customers from the proliferation of counterfeit parts. Fairchild strongly encourages customers to purchase Fairchild parts either directly from Fairchild or from Authorized Fairchild Distributors who are listed by country on our web page cited above. Products customers buy either from fairchild directly or from Authorized Fairchild Distributors are genuine parts, have full traceability, meet Fairchild's quality standards for handling and storage and provide access to Fairchild's full range of up-to-date technical and product information. Fairchild and our Authorized Distributors will stand behind all warranties and will appropriately address and warranty issues that may arise. Fairchild will not provide any warranty coverage or other assistance for parts bought from Unauthorized Sources. Fairchild is committed to combat this global problem and encourage our customers to do their part in stopping this practice by buying direct or from authorized distributors.

PRODUCT STATUS DEFINITIONS

Definition of Terms

Datasheet Identification	Product Status	Definition
Advance Information	Formative / In Design	Datasheet contains the design specifications for product development. Specifications may change in any manner without notice.
Preliminary	First Production	Datasheet contains preliminary data; supplementary data will be published at a later date. Fairchild Semiconductor reserves the right to make changes at any time without notice to improve design.
No Identification Needed	Full Production	Datasheet contains final specifications. Fairchild Semiconductor reserves the right to make changes at any time without notice to improve the design.
Obsolete	Not In Production	Datasheet contains specifications on a product that is discontinued by Fairchild Semiconductor. The datasheet is for reference information only.

Rev. I35