

Silicon NPN Power Transistors

2SC4512

DESCRIPTION

- With TO-220C package
- Complement to type 2SA1726

APPLICATIONS

- Audio and General Purpose

PINNING

PIN	DESCRIPTION
1	Base
2	Collector;connected to mounting base
3	Emitter

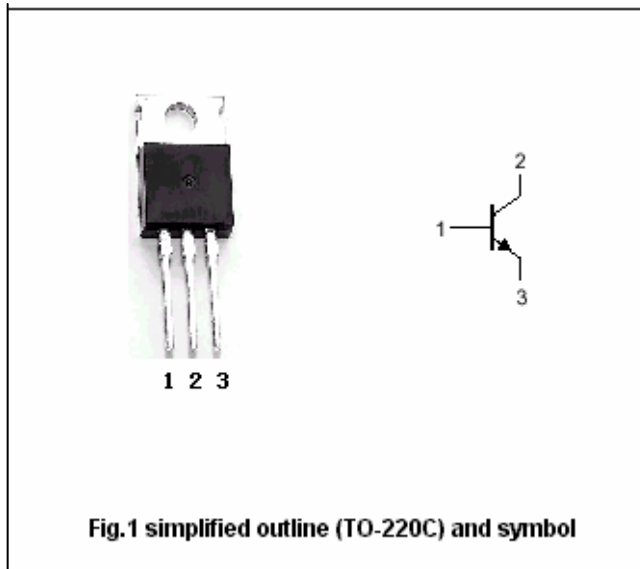

Absolute maximum ratings(Ta=25 )

SYMBOL	PARAMETER	CONDITIONS	VALUE	UNIT
V <sub>CBO</sub>	Collector-base voltage	Open emitter	120	V
V <sub>CEO</sub>	Collector-emitter voltage	Open base	80	V
V <sub>EBO</sub>	Emitter-base voltage	Open collector	6	V
I <sub>C</sub>	Collector current		6	A
I <sub>B</sub>	Base current		3	A
P <sub>C</sub>	Collector dissipation	T <sub>C</sub> =25	50	W
T <sub>j</sub>	Junction temperature		150	
T <sub>stg</sub>	Storage temperature		-55~150	

## Silicon NPN Power Transistors

## 2SC4512

## CHARACTERISTICS

T<sub>j</sub>=25 unless otherwise specified

SYMBOL	PARAMETER	CONDITIONS	MIN	TYP.	MAX	UNIT
V <sub>(BR)CEO</sub>	Collector-emitter breakdown voltage	I <sub>C</sub> =25mA; R <sub>BE</sub> =	80			V
V <sub>CE(sat)</sub>	Collector-emitter saturation voltage	I <sub>C</sub> =5A; I <sub>B</sub> =0.2A			0.5	V
I <sub>CBO</sub>	Collector cut-off current	V <sub>CB</sub> =120V; I <sub>E</sub> =0			10	μA
I <sub>EBO</sub>	Emitter cut-off current	V <sub>EB</sub> =6V; I <sub>C</sub> =0			10	μA
h <sub>FE</sub>	DC current gain	I <sub>C</sub> =2A; V <sub>CE</sub> =4V	50			
C <sub>OB</sub>	Collector output capacitance	f=1MHz; V <sub>CB</sub> =10V		110		pF
f <sub>T</sub>	Transition frequency	I <sub>E</sub> =-0.5A; V <sub>CE</sub> =12V		20		MHz

## Switching times

t <sub>on</sub>	Turn-on time	V <sub>CC</sub> =30V; I <sub>C</sub> =3A I <sub>B1</sub> =-I <sub>B2</sub> =0.3A R <sub>L</sub> =10	0.16		μs
t <sub>stg</sub>	Storage time		2.60		μs
t <sub>f</sub>	Fall time		0.34		μs

◆ h<sub>FE</sub> Classifications

O	P	Y
50-100	70-140	90-180

Silicon NPN Power Transistors

2SC4512

PACKAGE OUTLINE

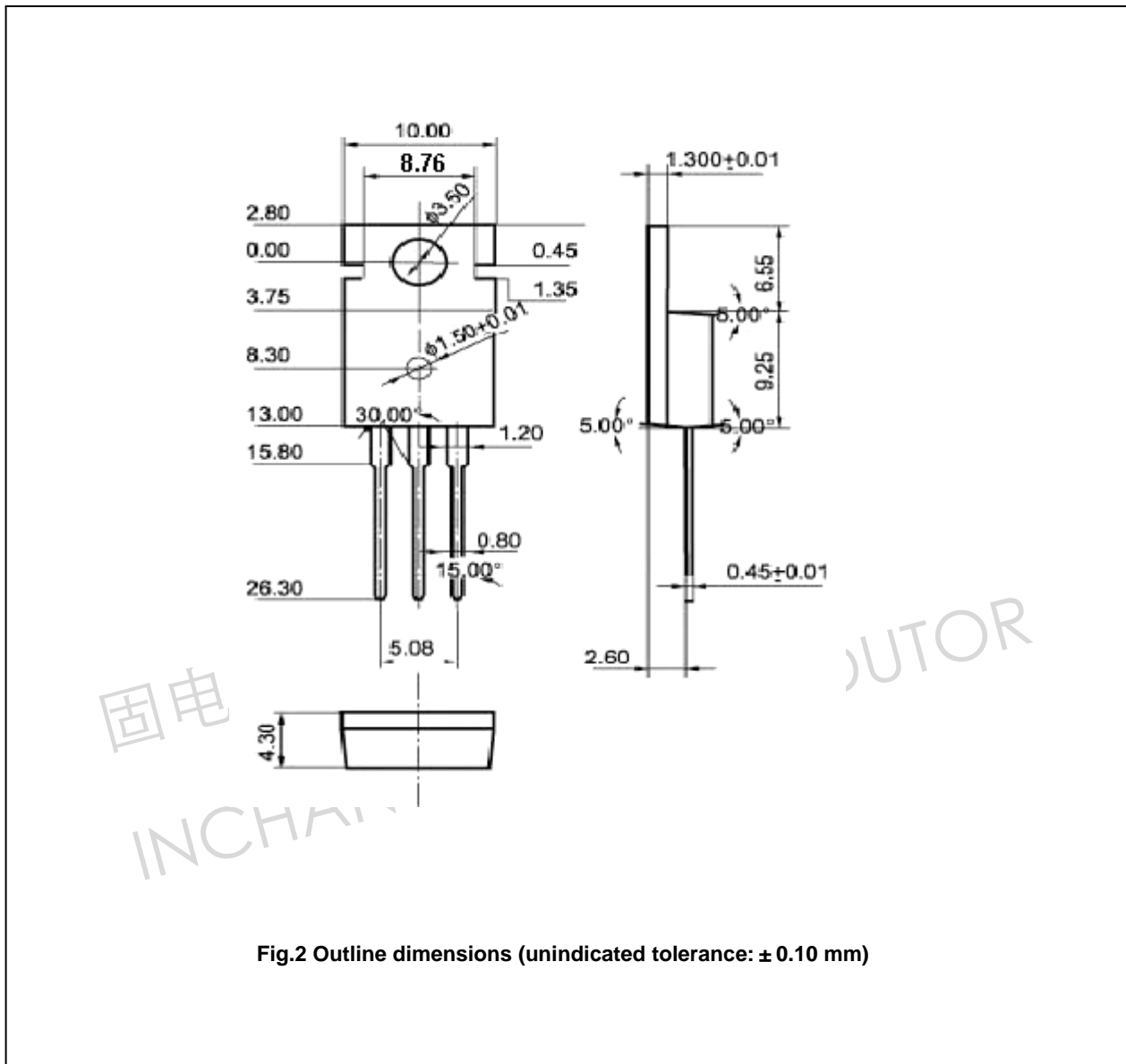

Silicon NPN Power Transistors

2SC4512

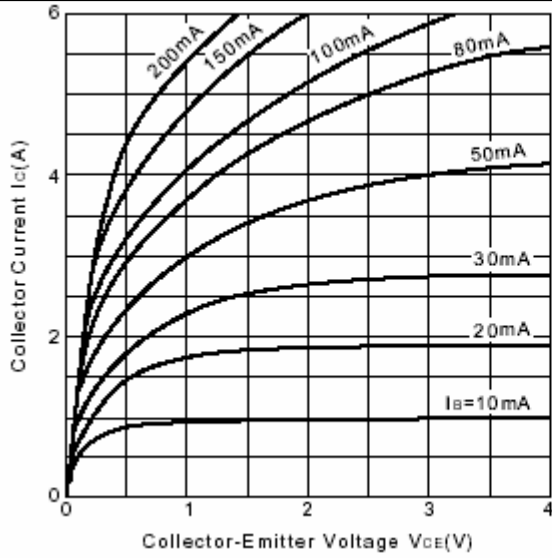

Fig.3 Static Characteristic

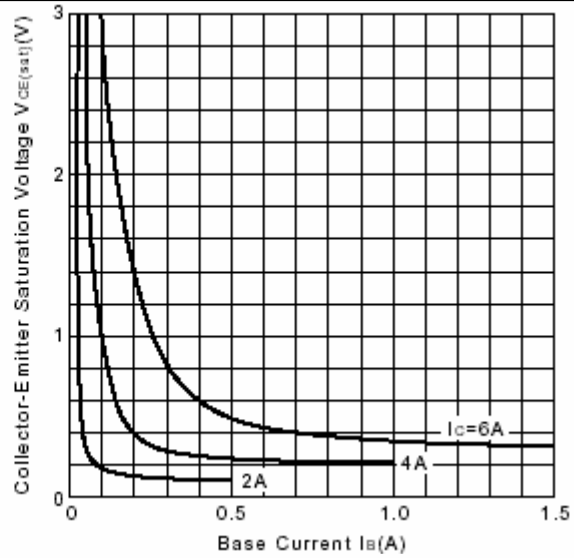

Fig.4  $V_{CE(sat)}-I_B$  Characteristics

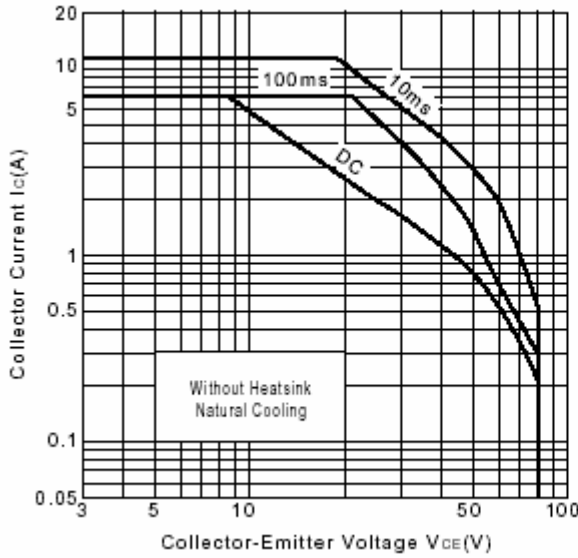

Fig.5 Safe Operating Area

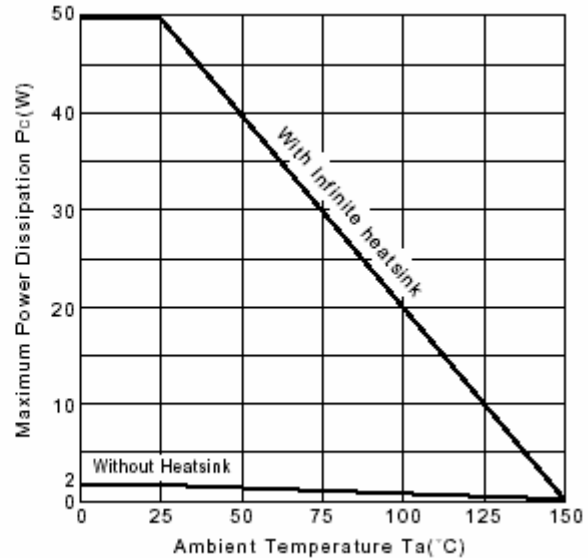

Fig.6  $P_c-T_a$  Derating

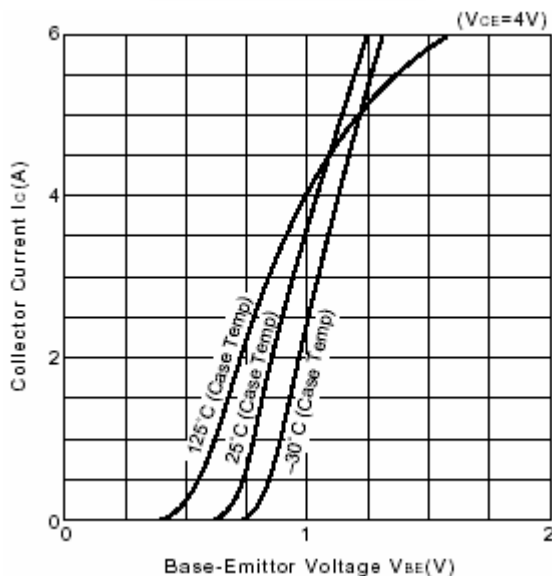

Fig.7  $I_C-V_{BE}$

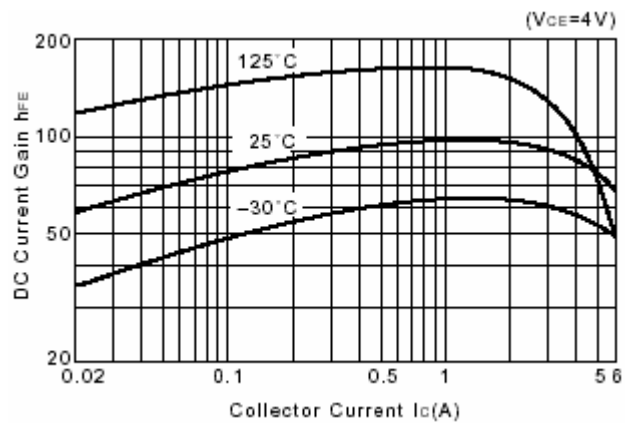

Fig.8 DC current Gain