

isc Silicon NPN Darlington Power Transistor

TIP101

DESCRIPTION

- High DC Current Gain-
: $h_{FE} = 1000(\text{Min}) @ I_C = 3A$
- Collector-Emitter Sustaining Voltage-
: $V_{CEO(\text{SUS})} = 80V(\text{Min})$
- Low Collector-Emitter Saturation Voltage-
: $V_{CE(\text{sat})} = 2.0V(\text{Max}) @ I_C = 3A$
= $2.5V(\text{Max}) @ I_C = 8A$
- Complement to Type TIP106

APPLICATIONS

- Designed for general-purpose amplifier and low-speed switching applications

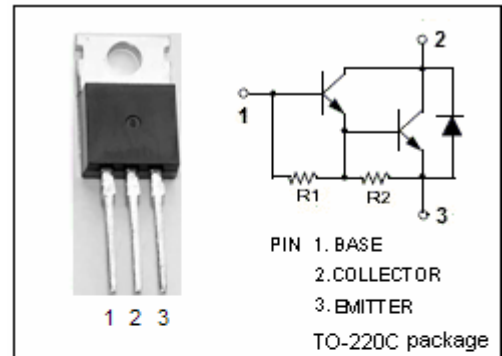

ABSOLUTE MAXIMUM RATINGS($T_a=25^\circ\text{C}$)

SYMBOL	PARAMETER	VALUE	UNIT
V_{CBO}	Collector-Base Voltage	80	V
V_{CEO}	Collector-Emitter Voltage	80	V
V_{EBO}	Emitter-Base Voltage	5	V
I_C	Collector Current-Continuous	8	A
I_{CM}	Collector Current-Peak	15	A
I_B	Base Current- Continuous	1	A
P_C	Collector Power Dissipation @ $T_C=25^\circ\text{C}$	80	W
	Collector Power Dissipation @ $T_a=25^\circ\text{C}$	2	
T_j	Junction Temperature	150	$^\circ\text{C}$
T_{stg}	Storage Temperature Range	-65~150	$^\circ\text{C}$

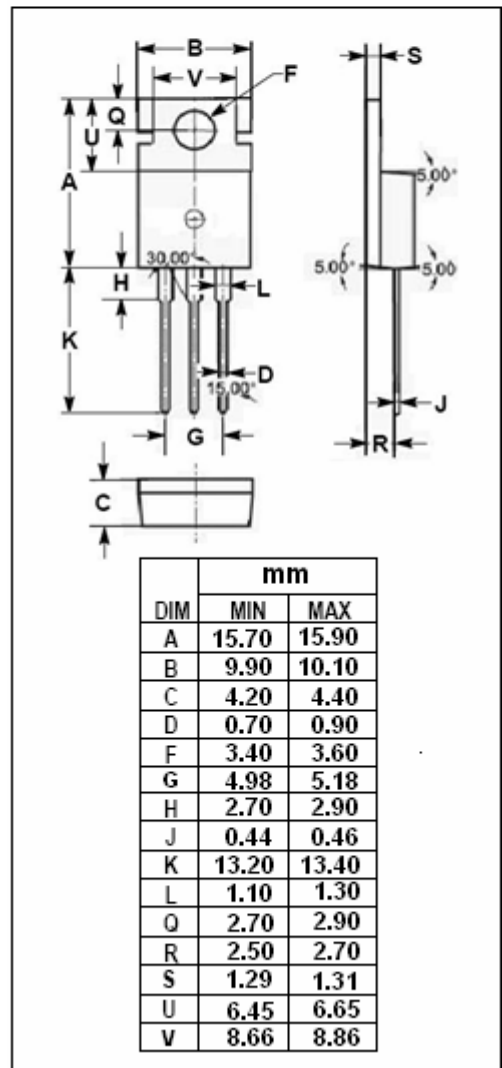

THERMAL CHARACTERISTICS

SYMBOL	PARAMETER	MAX	UNIT
$R_{th\ j-c}$	Thermal Resistance, Junction to Case	1.56	$^\circ\text{C/W}$
$R_{th\ j-a}$	Thermal Resistance, Junction to Ambient	62.5	$^\circ\text{C/W}$

isc Silicon NPN Darlington Power Transistor

TIP101

ELECTRICAL CHARACTERISTICS

 $T_C=25^{\circ}\text{C}$ unless otherwise specified

SYMBOL	PARAMETER	CONDITIONS	MIN	MAX	UNIT
$V_{CEO(SUS)}$	Collector-Emitter Sustaining Voltage	$I_C=30\text{mA}$, $I_B=0$	80		V
$V_{CE(sat)-1}$	Collector-Emitter Saturation Voltage	$I_C=3\text{A}$; $I_B=6\text{mA}$		2.0	V
$V_{CE(sat)-2}$	Collector-Emitter Saturation Voltage	$I_C=8\text{A}$, $I_B=80\text{mA}$		2.5	V
$V_{BE(on)}$	Base-Emitter On Voltage	$I_C=8\text{A}$; $V_{CE}=4\text{V}$		2.8	V
I_{CBO}	Collector Cutoff Current	$V_{CB}=80\text{V}$, $I_E=0$		50	μA
I_{CEO}	Collector Cutoff Current	$V_{CE}=40\text{V}$, $I_B=0$		50	μA
I_{EBO}	Emitter Cutoff Current	$V_{EB}=5\text{V}$; $I_C=0$		8	mA
h_{FE-1}	DC Current Gain	$I_C=3\text{A}$; $V_{CE}=4\text{V}$	1000	20000	
h_{FE-2}	DC Current Gain	$I_C=8\text{A}$; $V_{CE}=4\text{V}$	200		
C_{OB}	Output Capacitance	$I_E=0$; $V_{CB}=10\text{V}$, $f=0.1\text{MHz}$		200	pF