

### 1. Package Dimension

( S22 )

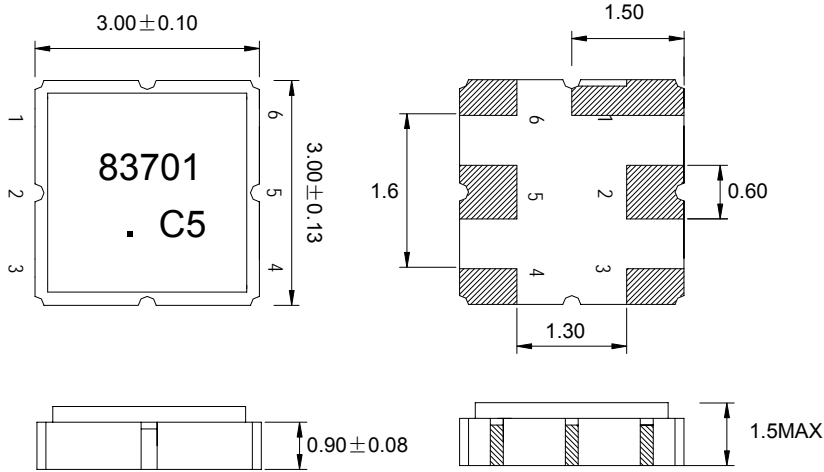

Unit: mm

Pin No.	Function
1.	Ground
2.	Signal
3.	Ground
4.	Ground
5.	Signal
6.	Ground

### 2. Marking

**83701**

Part Number

(1) Ink Marking or Laser Marking

(2) 01: Model code

(3) ∴ Pin 1 Identifier

(4) C5: Date code

**.C5**

C  
Month code

5  
Last figure of year

Month	1	2	3	4	5	6	7	8	9	10	11	12
Month code	A	B	C	D	E	F	G	H	I	J	K	L

e.g.: "C5" means May of 2005

	<b>SIPAT Co., Ltd.</b> ( CETC No. 26 Research Institute ) Nanping Huayuan Road No. 14 Chongqing, China, 400060	Part Number	SP83701	
		Rev. Date	2006-8-9	
		Rev.	1.0	Page

### 3. Performance

#### 3.1 Application

RF SAW filter for cellular telephone.  
Center frequency: 836.5MHz

#### 3.2 Maximum Rating

Operation Temperature Range	-30°C to +80°C
Storage Temperature Range	-40°C to +85°C
DC Permissive Voltage	10V DC max.
Maximum Input Power	23 dBm

#### 3.3 Electronic Characteristics

Item	Frequency (MHz)	Specification
Center Frequency (fo)	836.5	
Pass-band Width	25	
Insertion Loss	824 ~ 849	2.5 dB max.
Pass-band Ripple	824 ~ 849	1.5 dB max.
Return Loss	824 ~ 849	10.0 dB min.
Stop-band Attenuation	DC ~ 800	20 dB min.
	869 ~ 894	30 dB min.
	978 ~ 1006	25 dB min.
	1050 ~ 2600	20 dB min.

	<b>SIPAT Co., Ltd.</b> ( CETC No. 26 Research Institute ) Nanping Huayuan Road No. 14 Chongqing, China, 400060	Part Number	SP83701	
		Rev. Date	2006-8-9	
		Rev.	1.0	Page

3.4 Frequency Characteristics

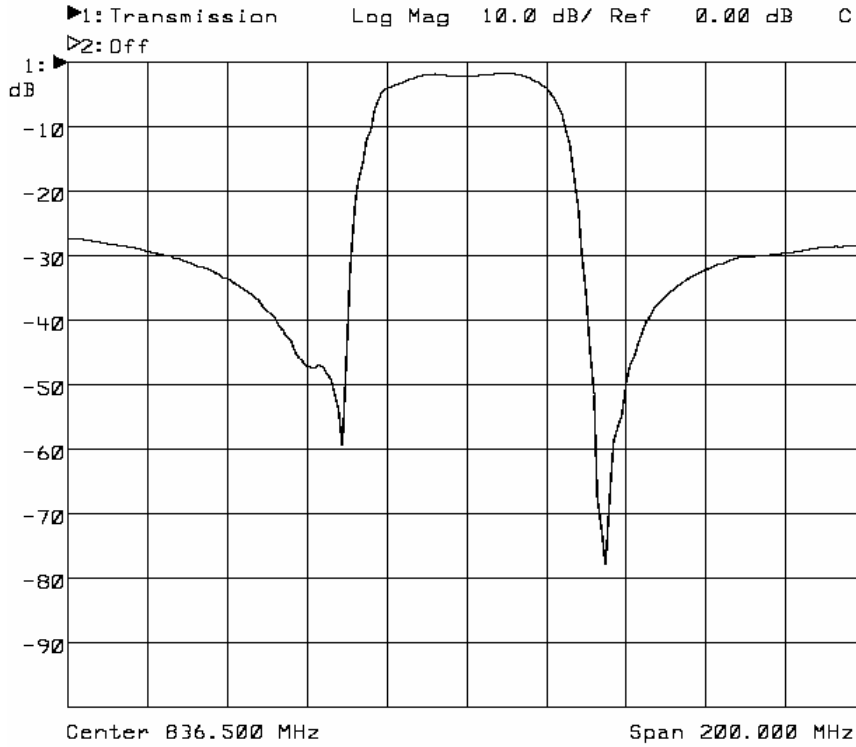

3.5 Test Circuit

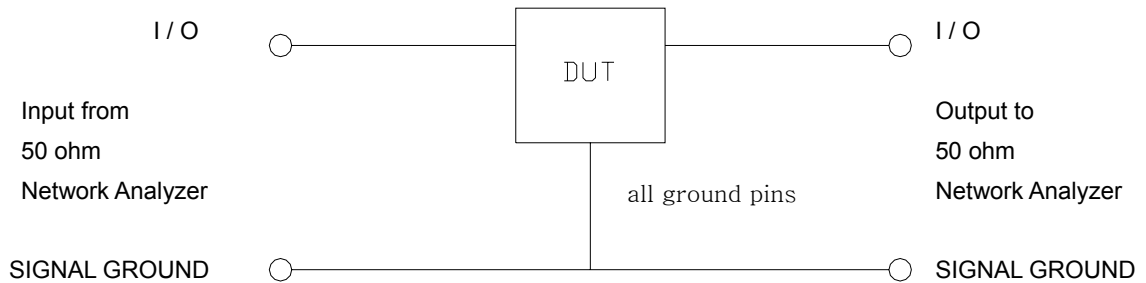

	<b>SIPAT Co., Ltd.</b> ( CETC No. 26 Research Institute ) Nanping Huayuan Road No. 14 Chongqing, China, 400060	Part Number	SP83701	
		Rev. Date	2006-8-9	
		Rev.	1.0	Page

#### 4. Reliability

- 4.1 Mechanical Shock: The components shall remain within the electrical specifications after three one-half sine shock pulses(3000g's for 0.3 ms) in each direction(for six total) along each of the three mutually perpendicular axes for a total of 18 shocks.
- 4.2 Vibration Fatigue: The components shall remain within the electrical specifications after loaded vibration at 20~55Hz, amplitude 1.5mm, X,Y,Z, direction, for 2 hours.
- 4.3 Leak Test
- 4.3.1 Gross Leak Test: Submerge samples into at +85°C water for at least 1 minute. Carefully observe the samples. No bubbles should be seen.
- 4.3.2 Fine Leak Test: Expose samples for testing to 60 PSIG Helium gas for 2 hours. Then transfer the same samples to another chamber and draw a vacuum. Measure the leak rate. Failure is defined if the leak rate exceeds  $5 \times 10^{-8}$  atm cc/sec Helium.
- 4.4 High Temperature Storage: The components shall remain within the electrical specifications after being kept at the  $85^\circ\text{C} \pm 2^\circ\text{C}$  for 960 hours, then kept at room temperature for 2 hours.
- 4.5 Low Temperature Storage: The components shall remain within the electrical specifications after being kept at the  $-40^\circ\text{C} \pm 2^\circ\text{C}$  for 960 hours, then kept at room temperature for 2 hours.
- 4.6 Temperature Cycle: The components shall remain within the electrical specification after 32 cycles of high and low temperature testing (one cycle:  $80^\circ\text{C}$  for 30 minutes  $\rightarrow$   $25^\circ\text{C}$  for 20 seconds  $\rightarrow$   $-40^\circ\text{C}$  for 30 minutes) than kept at room temperature for 2 hours.
- 4.7 Humidity Test: The components shall remain within the electrical specifications after being kept at the condition of ambient temperature  $70^\circ\text{C}$ , and 90~95% RH for 240 hours, then kept at room temperature and normal humidity for 4 hours.
- 4.8 Solder-heat Resistance: The components shall remain within the electrical specifications after dipped in the solder at  $260^\circ\text{C} \pm 5^\circ\text{C}$  for 10 to 11 seconds, then kept at room temperature for 10 minutes.
- 4.9 Solderability: Solderability of terminal shall be kept at more than 80% after dipped in the solder flux at  $230^\circ\text{C} \pm 5^\circ\text{C}$  for  $5 \pm 1$  seconds.
- 4.10 Storage: The components shall meet the electrical and mechanical specifications after 5 years storage, if stored within the temperature range of  $-40^\circ\text{C} \sim +85^\circ\text{C}$  and in the humidity of 20 to 60% r.h.

#### 5. Remarks

##### 5.1 Static voltage

Static voltage between signal load & ground may cause deterioration & destruction of the component. Please avoid static voltage.

	<b>SIPAT Co., Ltd.</b> ( CETC No. 26 Research Institute ) Nanping Huayuan Road No. 14 Chongqing, China, 400060	Part Number	SP83701	
		Rev. Date	2006-8-9	
		Rev.	1.0	Page

5.2 Ultrasonic cleaning

Ultrasonic vibration may cause deterioration & destruction of the component. Please avoid ultrasonic cleaning.

5.3 Soldering

Only leads of component may be soldered. Please avoid soldering another part of component.

**6. Packing**

6.1 Dimensions

- (1) Carrier Tape: Figure 1
- (2) Reel: Figure 2
- (3) The product shall be packed properly not to be damaged during transportation and storage.

6.2 Reeling Quantity

3,000pcs/reel

6.3 Taping Structure

- (1) The tape shall be wound around the reel in the direction shown below.

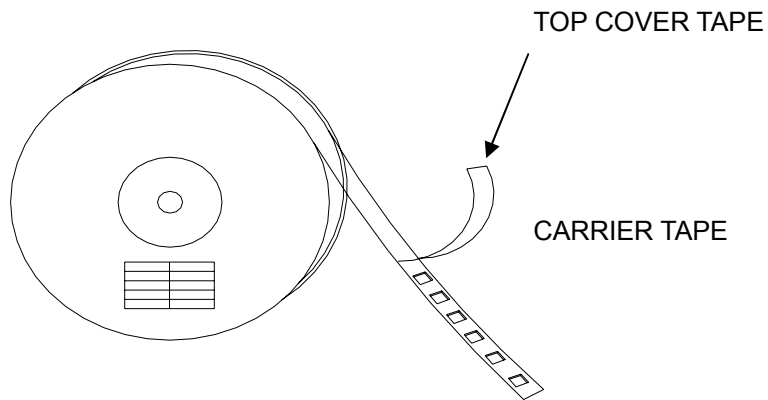

(2)Lable

Device Name	
Type	
Quantity	
Lot No.	

	<b>SIPAT Co., Ltd.</b> ( CETC No. 26 Research Institute ) Nanping Huayuan Road No. 14 Chongqing, China, 400060	Part Number	SP83701	
		Rev. Date	2006-8-9	
		Rev.	1.0	Page

(2) Leader part and vacant position specifications.

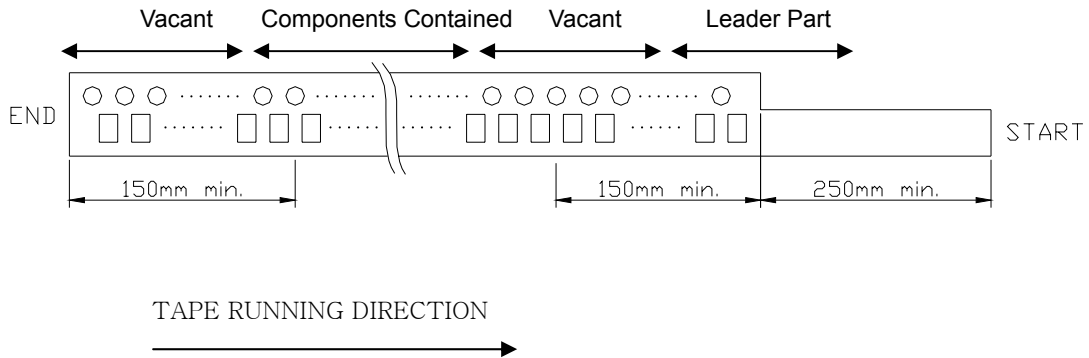

## 7. Tape Specifications

7.1 Tensile Strength of Carrier Tape: 4.4N/mm width

7.2 Top Cover Tape Adhesion (See the below figure)

- (1) pull off angle: 0~15°
- (2) speed: 300mm/min.
- (3) force: 20~70g

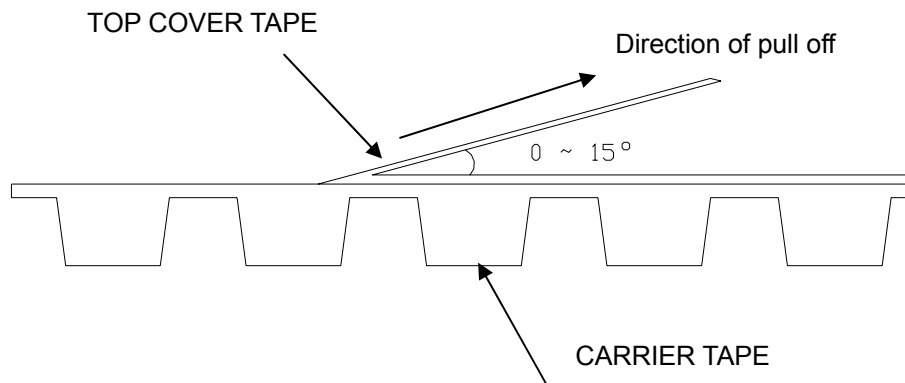

**SIPAT Co., Ltd.**  
( CETC No. 26 Research Institute )  
Nanping Huayuan Road No. 14  
Chongqing, China, 400060

Part Number	SP83701	
Rev. Date	2006-8-9	
Rev.	1.0	Page 6/8

[Figure 1] Carrier Tape Dimensions

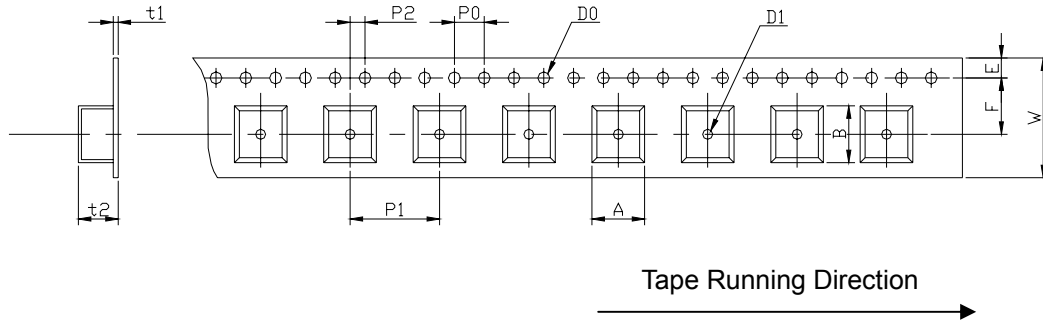

[Unit: mm]

W	F	E	P0	P1	P2	D0	D1	t1	t2	A	B
12.0	5.5	1.75	4.0	4.0	2.0	$\Phi 1.5$	$\Phi 1.5$	0.31	1.95	3.3	3.3
$\pm 0.3$	$\pm 0.1$	$\pm 0.1$	$\pm 0.2$	$\pm 0.1$	$\pm 0.2$	$\pm 0.1$	$\pm 0.25$	max.	max.	max.	max.

[Figure 2] Reel Dimensions

[Unit: mm]

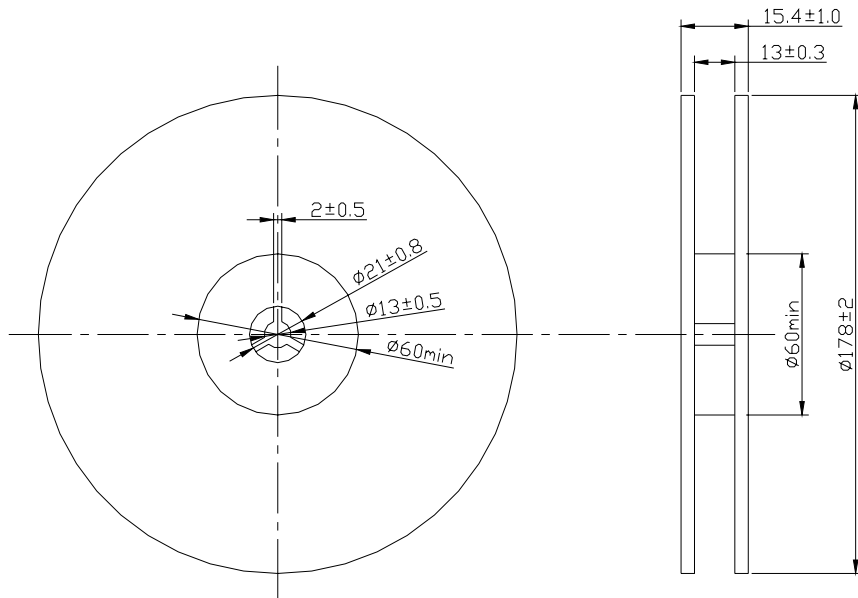

	<b>SIPAT Co., Ltd.</b> ( CETC No. 26 Research Institute ) Nanping Huayuan Road No. 14 Chongqing, China, 400060	Part Number	SP83701	
		Rev. Date	2006-8-9	
		Rev.	1.0	Page

[Figure 3] Part Direction

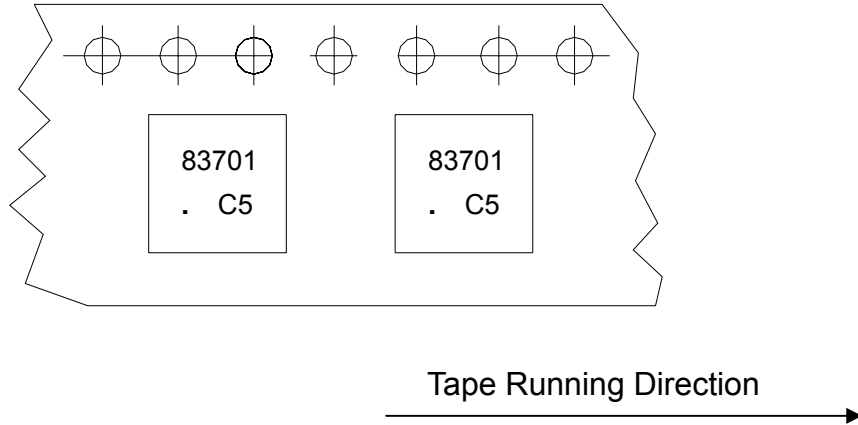

	<b>SIPAT Co., Ltd.</b> ( CETC No. 26 Research Institute ) Nanping Huayuan Road No. 14 Chongqing, China, 400060	Part Number	SP83701	
		Rev. Date	2006-8-9	
		Rev.	1.0	Page 8/8