



### Features

- ◇ For IF SAW filter
- ◇ High attenuation
- ◇ Single-ended operation
- ◇ Dual In-line Package
- ◇ RoHS compliant (2002/95/EC), Pb-free

### Specifications

Parameter	Unit	Minimum	Typical	Maximum
Center Frequency	MHz	139.9	140	140.1
Insertion Loss	dB	-	24	27.5
1 dB Bandwidth	MHz	2.4	2.68	-
3 dB Bandwidth	MHz	3	3.08	-
40 dB Bandwidth	MHz	-	4.64	5
50 dB Bandwidth	MHz	-	4.81	5.1
Passband Variation	dB	-	0.4	0.5
Group Delay Variation( $f_0 \pm$ MHz)	nsec	-	45	90
Phase Linearity( $f_0 \pm$ MHz)	deg	-	1.5	3
Absolute Delay	usec	-	2.44	-
Ultimate Rejection	dB	50	55	-
Material Temperature coefficient	KHz/°C	0.14		
Substrate Material	-	Qz		
Ambient Temperature	°C	25		
Operating Temperature Range	°C	-40	-	+85
Storage Temperature Range	°C	-45	-	+105
DC Voltage	V	0		
Input Power	dBm	-	-	10
ESD Class	-	1A		
Package Size	DIP2212 (22.2x12.8x4.7mm3)			

#### Notes:

1. All specifications are based on the test circuit shown;
2. In production, all specifications are measured by Agilent Network analyzer and full 2 port calibration at room temperature;
3. Electrical margin has been built into the design to account for the variations due to temperature drift and manufacturing tolerances;
4. This is the optimum impedance in order to achieve the performance show.

	<b>SIPAT Co., Ltd.</b> ( CETC No.26 Research Institute ) #14 Nanping Huayuan Road, Chongqing, China, 400060	Part Number	LBS14024	
		Rev. Date	2008-04-07	
		Ver.	1.0	Page

### Matching Configuration

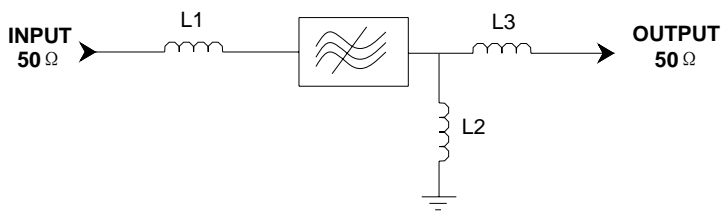

**L1=100nH L2=82nH L3=68nH**  
**Source/Load Impedance=50 ohm**

Notes - Component values may change depending on board layout.

### Package Dimension

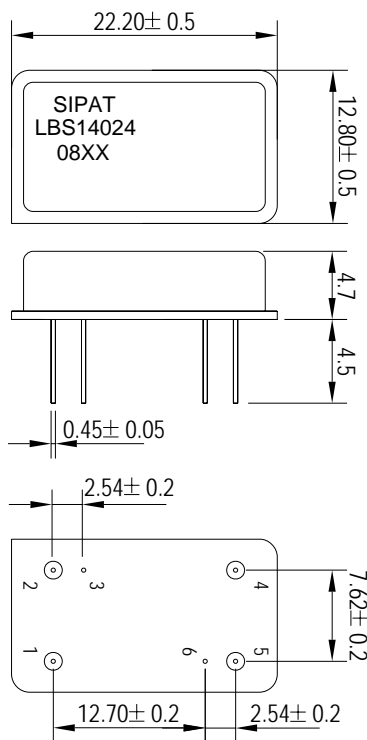

#### Pad Configuration:

Input 1  
 Output 5  
 Ground All Others

#### Marking Configuration:

- 1) SIPAT: Manufacturer Name
- 2) LBS14024: Part Number
- 3) 08XX: Date Code

Package: DIP2212

Unit: mm



**SIPAT Co., Ltd.**  
( CETC No.26 Research Institute )  
#14 Nanping Huayuan Road,  
Chongqing, China, 400060

Part Number	LBS14024	
Rev. Date	2008-04-07	
Ver.	1.0	Page 2/3

Typical Performance

Frequency Respond

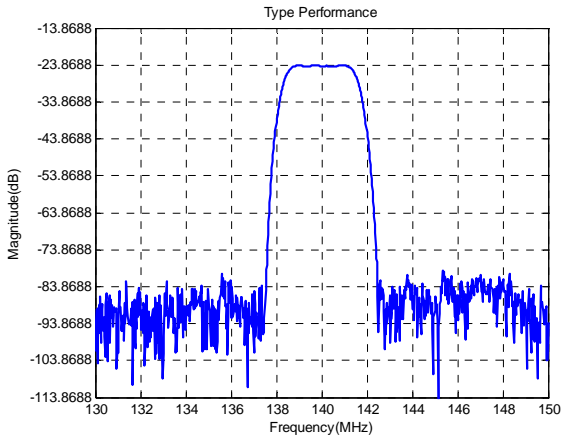

Horizontal: 2MHz/Div Vertical: 10dB/Div

Passband Respond

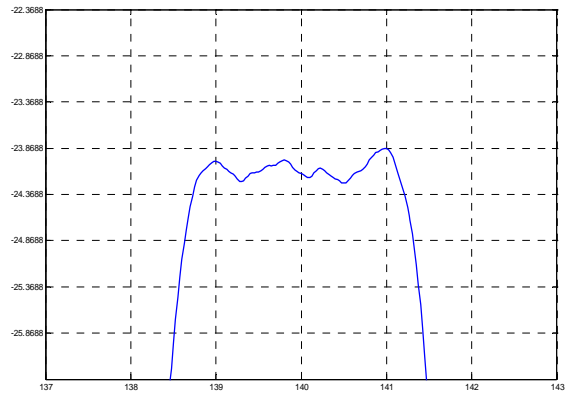

Horizontal: 1MHz/Div Vertical: 0.5dB/Div

Group Delay Variation( $f_0 \pm 1.5\text{MHz}$ )

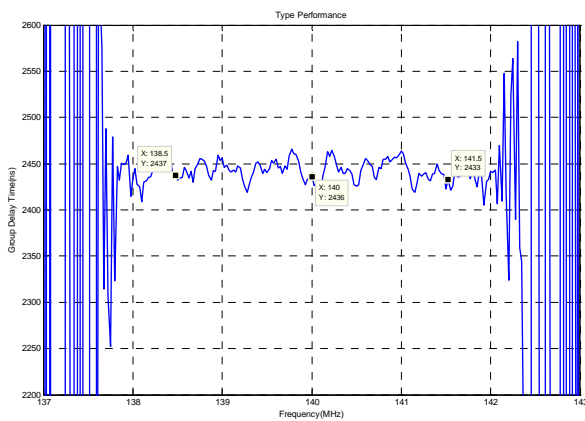

Horizontal: 1MHz/Div Vertical: 50ns/Div

Phase Linearity( $f_0 \pm 1.5\text{MHz}$ )

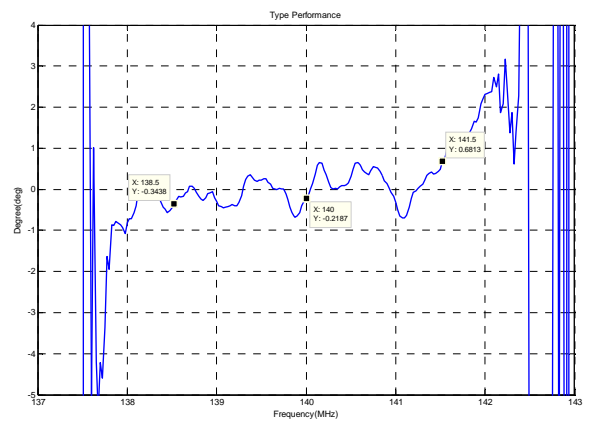

Horizontal: 1MHz/Div Vertical: 1deg/Div

Smith Chart S11

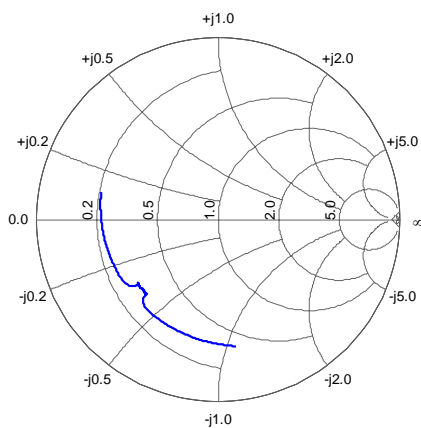

Smith Chart S22

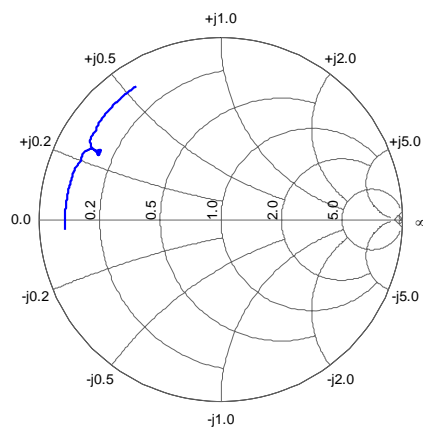

**SIPAT Co., Ltd.**  
( CETC No.26 Research Institute )  
#14 Nanping Huayuan Road,  
Chongqing, China, 400060

Part Number	LBS14024	
Rev. Date	2008-04-07	
Ver.	1.0	Page 3/3