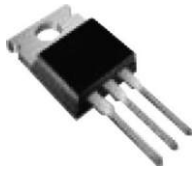
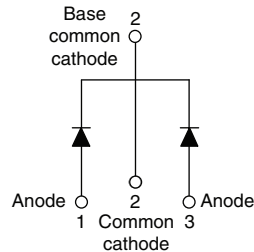

High Performance Schottky Generation 5.0, 40 A

TO-220AB

FEATURES

- 175 °C high performance Schottky diode
- Very low forward voltage drop
- Extremely low reverse leakage
- Optimized V_F vs. I_F trade off for high efficiency
- Increased ruggedness for reverse avalanche capability
- RBSOA available
- Negligible switching losses
- Submicron trench technology
- Full lead (Pb)-free and RoHS compliant devices
- Designed and qualified for industrial level

**RoHS
COMPLIANT**
PRODUCT SUMMARY

| | |
|-------------|-------|
| $I_{F(AV)}$ | 40 A |
| V_R | 100 V |

APPLICATIONS

- High efficiency SMPS
- Automotive
- High frequency switching
- Output rectification
- Reverse battery protection
- Freewheeling
- Dc-to-dc systems
- Increased power density systems

MAJOR RATINGS AND CHARACTERISTICS

| SYMBOL | CHARACTERISTICS | VALUES | UNITS |
|-------------|--|-------------|-------|
| $I_{F(AV)}$ | Rectangular waveform | 40 | A |
| V_{RRM} | | 100 | V |
| V_F | 20 Apk, $T_J = 125\text{ °C}$ (typical, per leg) | 0.63 | |
| T_J | Range | - 55 to 175 | °C |

VOLTAGE RATINGS

| PARAMETER | SYMBOL | TEST CONDITIONS | 43CTT100 | UNITS |
|----------------------------|--------|----------------------|----------|-------|
| Maximum DC reverse voltage | V_R | $T_J = 25\text{ °C}$ | 100 | V |

ABSOLUTE MAXIMUM RATINGS

| PARAMETER | SYMBOL | TEST CONDITIONS | VALUES | UNITS |
|---|-------------|--|--------------------------------|-------|
| Maximum average forward current | $I_{F(AV)}$ | 50 % duty cycle at $T_C = 160\text{ °C}$, rectangular waveform | 20 | A |
| | | | 40 | |
| Maximum peak one cycle non-repetitive surge current per leg | I_{FSM} | 5 μ s sine or 3 μ s rect. pulse | 900 | A |
| | | 10 ms sine or 6 ms rect. pulse | | |
| Non-repetitive avalanche energy per leg | E_{AS} | $T_J = 25\text{ °C}$, $I_{AS} = 1.5\text{ A}$, $L = 60\text{ mH}$ | 67.5 | mJ |
| Repetitive avalanche current per leg | I_{AR} | Limited by frequency of operation and time pulse duration so that $T_J < T_{J\text{ max}}$. I_{AS} at $T_J\text{ max}$. as a function of time pulse See fig. 8 | I_{AS} at $T_J\text{ max}$. | A |

| ELECTRICAL SPECIFICATIONS | | | | | | |
|---------------------------------|----------------|---|-----------------------------------|------|--------|------------------|
| PARAMETER | SYMBOL | TEST CONDITIONS | | TYP. | MAX. | UNITS |
| Forward voltage drop per leg | $V_{FM}^{(1)}$ | 20 A | $T_J = 25\text{ }^\circ\text{C}$ | - | 0.8 | V |
| | | 40 A | | - | 0.95 | |
| | | 20A | $T_J = 125\text{ }^\circ\text{C}$ | - | 0.67 | |
| | | 40 A | | - | 0.8 | |
| Reverse leakage current per leg | $I_{RM}^{(1)}$ | $T_J = 25\text{ }^\circ\text{C}$ | $V_R = \text{Rated } V_R$ | - | 150 | μA |
| | | $T_J = 125\text{ }^\circ\text{C}$ | | - | 6 | mA |
| Junction capacitance per leg | C_T | $V_R = 5 V_{DC}$ (test signal range 100 kHz to 1 MHz) 25 °C | | 850 | - | pF |
| Series inductance per leg | L_S | Measured lead to lead 5 mm from package body | | 8.0 | - | nH |
| Maximum voltage rate of change | dV/dt | Rated V_R | | - | 10 000 | V/ μs |

Note(1) Pulse width < 300 μs , duty cycle < 2 %

| THERMAL - MECHANICAL SPECIFICATIONS | | | | |
|--|----------------|--------------------------------------|-------------|------------------------|
| PARAMETER | SYMBOL | TEST CONDITIONS | VALUES | UNITS |
| Maximum junction and storage temperature range | T_J, T_{Stg} | | - 55 to 175 | $^\circ\text{C}$ |
| Maximum thermal resistance, junction to case per leg | R_{thJC} | DC operation | 2 | $^\circ\text{C/W}$ |
| Typical thermal resistance, case to heatsink | R_{thCS} | Mounting surface, smooth and greased | 0.5 | |
| Approximate weight | | | 2 | g |
| | | | 0.07 | oz. |
| Mounting torque | minimum | | 6 (5) | kgf · cm (lbf · in) |
| | maximum | | 12 (10) | |
| Case style | | | TO-220AB | |
| Marking device | | | 43CTT100 | |

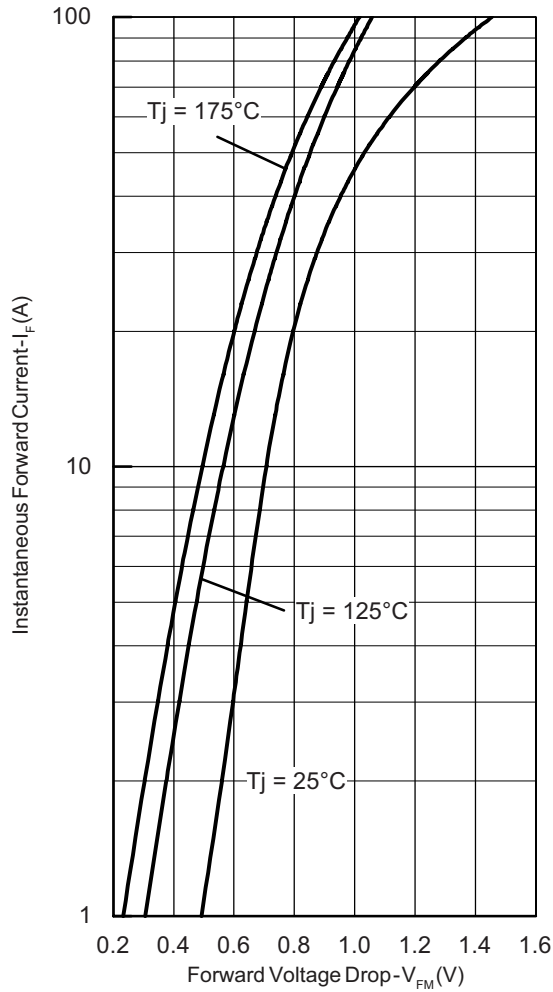

Fig. 1 - Maximum Forward Voltage Drop Characteristics

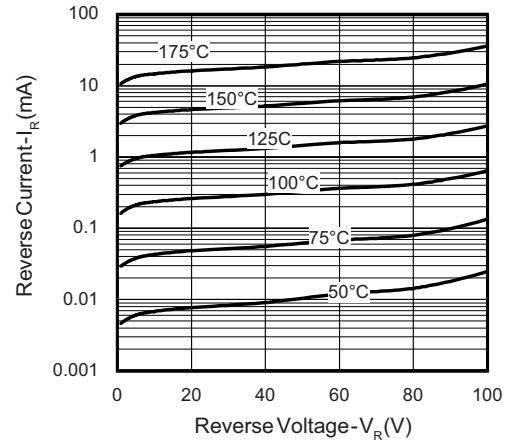

Fig. 2 - Typical Values of Reverse Current vs. Reverse Voltage

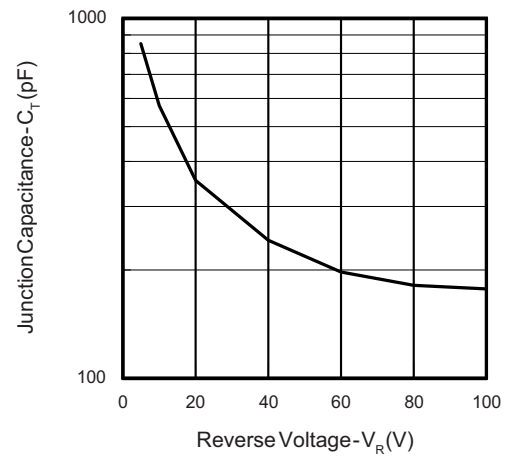

Fig. 3 - Typical Junction Capacitance vs. Reverse Voltage

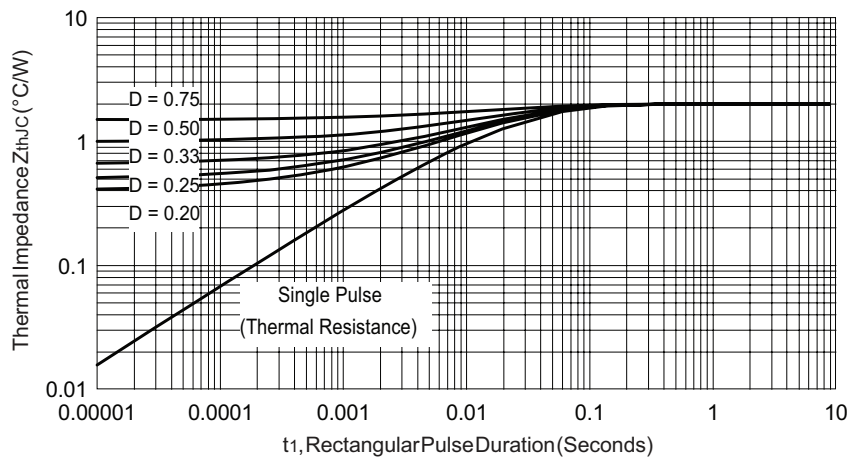

Fig. 4 - Maximum Thermal Impedance Z_{thJC} Characteristics

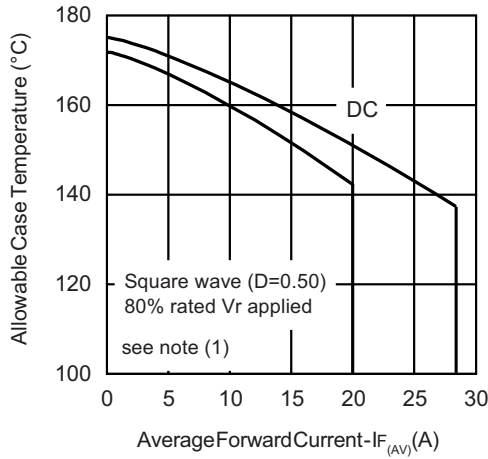

Fig. 5 - Maximum Allowable Case Temperature vs. Average Forward Current

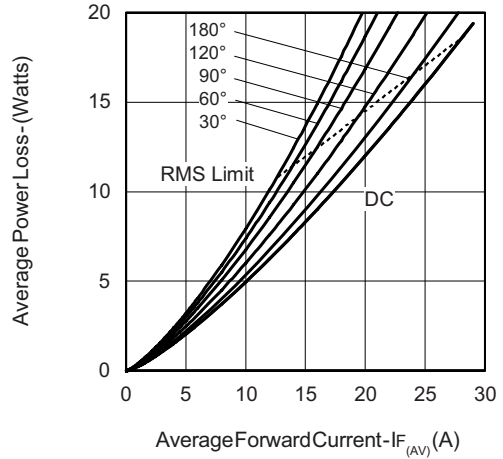

Fig. 6 - Forward Power Loss Characteristics

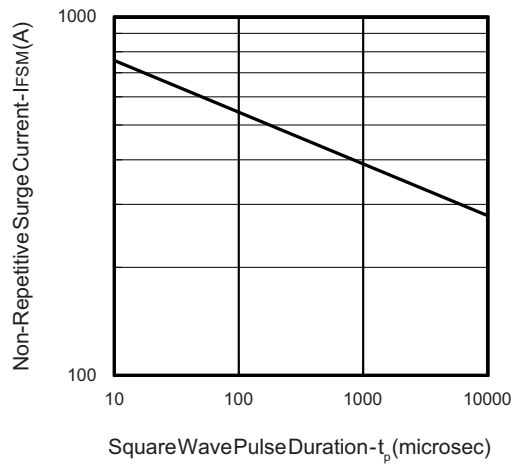

Fig. 7 - Maximum Non-Repetitive Surge Current

Note

- (1) Formula used: $T_C = T_J - (P_d + P_{d_{REV}}) \times R_{thJC}$;
- P_d = Forward power loss = $I_{F(AV)} \times V_{FM}$ at $(I_{F(AV)}/D)$ (see fig. 6);
- $P_{d_{REV}}$ = Inverse power loss = $V_{R1} \times I_R (1 - D)$; I_R at $V_{R1} = 80\%$ rated V_R

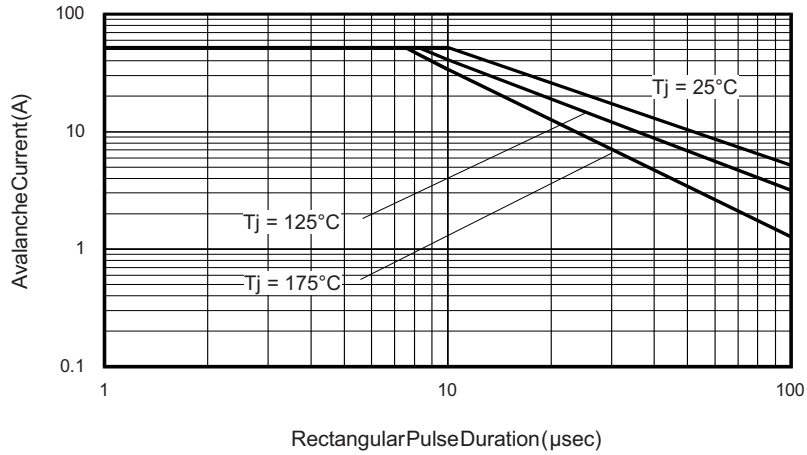

Fig. 8 - Reverse Bias Safe Operating Area (Avalanche Current vs. Rectangular Pulse Duration)

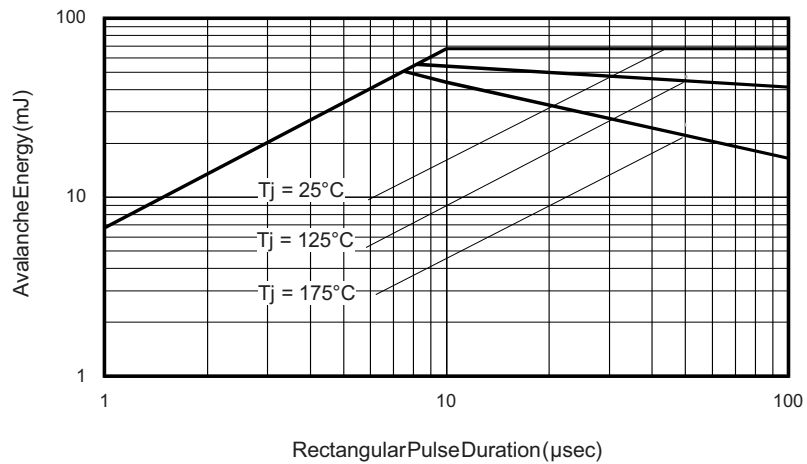
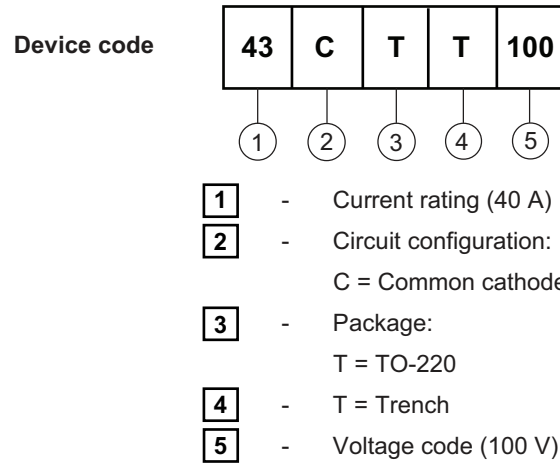

Fig. 9 - Reverse Bias Safe Operating Area (Avalanche Energy vs. Rectangular Pulse Duration)



ORDERING INFORMATION TABLE



Tube standard pack quantity: 50 pieces

| LINKS TO RELATED DOCUMENTS | |
|----------------------------|---|
| Dimensions | http://www.vishay.com/doc?95222 |
| Part marking information | http://www.vishay.com/doc?95225 |
| SPIICE model | http://www.vishay.com/doc?95230 |



Notice

The products described herein were acquired by Vishay Intertechnology, Inc., as part of its acquisition of International Rectifier's Power Control Systems (PCS) business, which closed in April 2007. Specifications of the products displayed herein are pending review by Vishay and are subject to the terms and conditions shown below.

Specifications of the products displayed herein are subject to change without notice. Vishay Intertechnology, Inc., or anyone on its behalf, assumes no responsibility or liability for any errors or inaccuracies.

Information contained herein is intended to provide a product description only. No license, express or implied, by estoppel or otherwise, to any intellectual property rights is granted by this document. Except as provided in Vishay's terms and conditions of sale for such products, Vishay assumes no liability whatsoever, and disclaims any express or implied warranty, relating to sale and/or use of Vishay products including liability or warranties relating to fitness for a particular purpose, merchantability, or infringement of any patent, copyright, or other intellectual property right.

The products shown herein are not designed for use in medical, life-saving, or life-sustaining applications. Customers using or selling these products for use in such applications do so at their own risk and agree to fully indemnify Vishay for any damages resulting from such improper use or sale.

International Rectifier®, IR®, the IR logo, HEXFET®, HEXSense®, HEXDIP®, DOL®, INTERO®, and POWIRTRAIN® are registered trademarks of International Rectifier Corporation in the U.S. and other countries. All other product names noted herein may be trademarks of their respective owners.