

## 300-mA Ultra Low-Noise LDO Regulator With Discharge Option

### FEATURES

- Ultra Low Dropout—300 mV at 300-mA Load
- Ultra Low Noise—30  $\mu\text{V}_{\text{RMS}}$  (10-Hz to 100-kHz)
- Shutdown Control
- 130- $\mu\text{A}$  Ground Current at 300-mA Load
- 1.5% Guaranteed Output Voltage Accuracy
- 400-mA Peak Output Current Capability
- Uses Low ESR Ceramic Capacitors
- Fast Start-Up (50  $\mu\text{s}$ )
- Fast Line and Load Transient Response ( $\leq 30 \mu\text{s}$ )
- 1- $\mu\text{A}$  Maximum Shutdown Current
- Output Current Limit
- Reverse Battery Protection
- Built-in Short Circuit and Thermal Protection



- Output, Auto-Discharge In Shutdown Mode
- Fixed 1.2, 1.8, 2.5, 2.6, 2.8, 3.0, 3.3, 5.0-V Output Voltage Options
- MLP33-5 PowerPAK® Package

### APPLICATIONS

- Cellular Phones, Wireless Handsets
- Noise-Sensitive Electronic Systems, Laptop and Palmtop Computers
- PDAs
- Pagers
- Digital Cameras
- MP3 Player
- Wireless Modem

### DESCRIPTION

The Si91871 is a 300-mA CMOS LDO (low dropout) voltage regulator. It is the perfect choice for low voltage, low power applications. An ultra low ground current makes this part attractive for battery operated power systems. The Si91871 also offers ultra low dropout voltage to prolong battery life in portable electronics. Systems requiring a quiet voltage source, such as RF applications, will benefit from the Si91871's ultra low output noise. An external noise bypass capacitor connected to the device's BP pin can further reduce the noise level. The Si91871 is designed to maintain regulation while delivering 400-mA peak current, making it ideal for systems that have a high surge current upon turn-on.

pull-down circuit is built into the Si91871 to clamp the output voltage when it rises beyond normal regulation. The Si91871 automatically discharges the output voltage by connecting the output to ground through a 100- $\Omega$  n-channel MOSFET when the device is put in shutdown mode.

The Si91871 features reverse battery protection to limit reverse current flow to approximately 1- $\mu\text{A}$  in the event reversed battery is applied at the input, thus preventing damage to the IC.

The Si91871 is available in both the standard and lead (Pb)-free 5-pin MLP33 PowerPAK packages and is specified to operate over the industrial temperature range of  $-40^{\circ}\text{C}$  to  $85^{\circ}\text{C}$ .

For better transient response and regulation, an active

### TYPICAL APPLICATION CIRCUIT

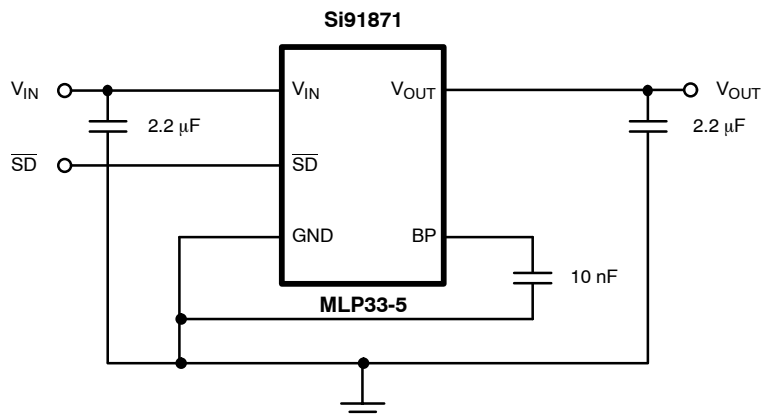



## ABSOLUTE MAXIMUM RATINGS

|  |                            |
|--|----------------------------|
| Absolute Maximum Ratings                       |                            |
| Input Voltage, $V_{IN}$ to GND                 | -6.0 to 6.5 V              |
| $\overline{V_{SD}}$ (See Detailed Description) | -0.3 V to $V_{IN}$         |
| Output Current, $I_{OUT}$                      | Short Circuit Protected    |
| Output Voltage, $V_{OUT}$                      | -0.3 V to $V_{IN} + 0.3$ V |
| Package Power Dissipation, $(P_d)^b$           | 2.3 W                      |

|   |   |
|---|---|
| Thermal Resistance ( $\theta_{JA}$ ) <sup>a</sup> | 55°C/W  |
| $R_{(\theta JA)}$ <sup>a</sup>                    | 8°C/W   |
| Maximum Junction Temperature, $T_{J(max)}$        | 150°C   |
| Storage Temperature, $T_{STG}$                    | -65°C to 150°C  |
| Notes   |   |
| a.  | Device mounted with all leads soldered or welded to PC board. |
| b.  | Derate 20 mW/°C above $T_A = 25^\circ\text{C}$                |

Stresses beyond those listed under "Absolute Maximum Ratings" may cause permanent damage to the device. These are stress ratings only, and functional operation of the device at these or any other conditions beyond those indicated in the operational sections of the specifications is not implied. Exposure to absolute maximum rating conditions for extended periods may affect device reliability.

|                                    |                   |
|------------------------------------|-------------------|
| Input Voltage, $V_{IN}$            | 2 V to 6 V        |
| Input Voltage, $\overline{V_{SD}}$ | 0 V to $V_{IN}$   |
| Output Current                     | 0 to 300 mA       |
| $C_{IN}$ , $C_{OUT}^a$ (Ceramic)   | 2.2 $\mu\text{F}$ |

|                                       |   |
|---------------------------------------|---|
| $C_{EB}$ (Ceramic)                    | 0.01 $\mu\text{F}$                        |
| Operating Ambient Temperature, $T_A$  | -40°C to 85°C                             |
| Operating Junction Temperature, $T_J$ | -40°C to 125°C                            |
| Notes                                 |   |
| a.                                    | Maximum ESR of $C_{OUT}$ : 0.2 $\Omega$ . |

| SPECIFICATIONS  |   |   |                              |                       |                  |                  |      |                  |
|---|---|---|------------------------------|-----------------------|------------------|------------------|------|------------------|
| Parameter   | Symbol  | Test Conditions Unless Specified<br>$T_A = 25^\circ\text{C}$ , $V_{IN} = V_{OUT(nom)} + 1$ V<br>$I_{OUT} = 1$ mA, $C_{IN} = 2$ $\mu\text{F}$ , $C_{OUT} = 2.0$ $\mu\text{F}$<br>$\overline{V_{SD}} = 1.5$ V |                              | Limits<br>-40 to 85°C |                  |                  | Unit |                  |
|   |   |   |                              | Temp <sup>a</sup>     | Min <sup>b</sup> | Typ <sup>c</sup> |      | Max <sup>b</sup> |
| Start-Up BP Current   | $I_{OUT}$   | ON/OFF = High   |                              | Room                  |                  | 1                | mA   |                  |
| Input Voltage Range   | $V_{IN}$  |   |                              | Full                  | 2                |                  | 6    | V                |
| Output Voltage Accuracy   |   | $1 \text{ mA} \leq I_{OUT} \leq 300 \text{ mA}$   | $V_{OUT} \geq 1.8 \text{ V}$ | Room                  | -2.0             | 1                | 2.0  | %                |
|   |   |   |                              | Full                  | -3.0             | 1                | 3.0  |                  |
|   |   |   |                              | Room                  | -2.5             | 1                | 2.5  |                  |
|   |   |   |                              | Full                  | -3.5             | 1                | 3.5  |                  |
| Line Regulation ( $V_{OUT} \leq 3$ V)   | $\frac{\Delta V_{OUT} \times 100}{\Delta V_{IN} \times V_{OUT(nom)}}$ | From $V_{IN} = V_{OUT(nom)} + 1$ V to $V_{OUT(nom)} + 2$ V  |                              | Full                  | -0.06            |                  | 0.18 | % / V            |
| Line Regulation<br>(3.0 V < $V_{OUT} \leq 3.6$ V)                               |   |   |                              | Full                  | 0                |                  | 0.3  |                  |
| Line Regulation (5-V Version)   |   | From $V_{IN} = 5.5$ V to 6 V  |                              | Full                  | 0                |                  | 0.4  |                  |
| Dropout Voltage <sup>d, g</sup><br>( $V_{OUT(nom)} \geq 2.6$ V)                 | $V_{IN} - V_{OUT}$  | $I_{OUT} = 1$ mA  |                              | Room                  |                  | 1                |      | mV               |
|   |   | $I_{OUT} = 50$ mA   |                              | Room                  |                  | 45               | 80   |                  |
|   |   |   |                              | Full                  |                  | 50               | 90   |                  |
|   |   | $I_{OUT} = 300$ mA  |                              | Room                  |                  | 300              | 350  |                  |
|   |   |   |                              | Full                  |                  |                  | 415  |                  |
|   |   |   |                              | Full                  |                  |                  |      |                  |
| Dropout Voltage <sup>d, g</sup><br>( $V_{OUT(nom)} < 2.6$ V, $V_{IN} \geq 2$ V) | $V_{IN} - V_{OUT}$  | $I_{OUT} = 50$ mA   |                              | Room                  |                  | 65               | 100  | mV               |
|   |   |   |                              | Full                  |                  |                  | 120  |                  |
|   |   | $I_{OUT} = 300$ mA  |                              | Room                  |                  | 400              | 520  |                  |
|   |   |   |                              | Full                  |                  |                  | 570  |                  |
|   |   |   |                              | Room                  |                  | 100              | 150  |                  |
|   |   |   |                              | Full                  |                  |                  | 180  |                  |
| Ground Pin Current <sup>e, g</sup><br>( $V_{OUT(nom)} \leq 3$ V)                | $I_{GND}$   | $I_{OUT} = 0$ mA  |                              | Room                  |                  | 110              | 170  | $\mu\text{A}$    |
|   |   |   |                              | Full                  |                  |                  | 200  |                  |
|   |   | $I_{OUT} = 300$ mA  |                              | Room                  |                  | 130              | 200  |                  |
|   |   |   |                              | Full                  |                  |                  | 330  |                  |
|   |   | $I_{OUT} = 0$ mA  |                              | Room                  |                  | 150              | 225  |                  |
|   |   |   |                              | Full                  |                  |                  | 275  |                  |
| Ground Pin Current <sup>e</sup><br>( $V_{OUT(nom)} > 3$ V)                      | $I_{GND}$   | $I_{OUT} = 0$ mA  |                              | Room                  |                  | 110              | 170  | $\mu\text{A}$    |
|   |   |   |                              | Full                  |                  |                  | 200  |                  |
|   |   | $I_{OUT} = 300$ mA  |                              | Room                  |                  | 150              | 225  |                  |
|   |   |   |                              | Full                  |                  |                  | 275  |                  |
| Peak Output current   | $I_{O(peak)}$   | $V_{OUT} \geq 0.95 \times V_{OUT(nom)}$ , $t_{PW} = 2$ ms   |                              | Full                  | 400              |                  |      | mA               |

| <b>SPECIFICATIONS</b>                                 |                                |  |                      |                       |                  |                  |                    |
|---|--------------------------------|--|----------------------|-----------------------|------------------|------------------|--------------------|
| Parameter   | Symbol                         | Test Conditions Unless Specified<br>$T_A = 25^\circ\text{C}$ , $V_{IN} = V_{OUT(nom)} + 1\text{ V}$<br>$I_{OUT} = 1\text{ mA}$ , $C_{IN} = 2\ \mu\text{F}$ , $C_{OUT} = 2.0\ \mu\text{F}$<br>$V_{SD} = 1.5\text{ V}$ | Temp <sup>a</sup>    | Limits<br>-40 to 85°C |                  |                  | Unit               |
|   |                                |  |                      | Min <sup>b</sup>      | Typ <sup>c</sup> | Max <sup>b</sup> |                    |
| Output Noise Voltage                                  | $e_N$                          | $V_{NOM} = 2.6\text{ V}$ , BW = 10 Hz to 100 kHz,<br>$0\text{ mA} < I_{OUT} < 300\text{ mA}$ , $C_{NOISE} = 0.01\ \mu\text{F}$   | Room                 |                       | 30               |                  | $\mu\text{V(rms)}$ |
| Ripple Rejection                                      | $\Delta V_{OUT}/\Delta V_{IN}$ | $I_{OUT} = 300\text{ mA}$  | $f = 1\text{ kHz}$   | Room                  | 60               |                  | dB                 |
|   |                                |  | $f = 10\text{ kHz}$  | Room                  | 40               |                  |                    |
|   |                                |  | $f = 100\text{ kHz}$ | Room                  | 30               |                  |                    |
| Dynamic Line Regulation                               | $\Delta V_{O(line)}$           | $V_{IN} : V_{OUT(nom)} + 1\text{ V}$ to $V_{OUT(nom)} + 2\text{ V}$<br>$t_r/t_f = 2\ \mu\text{s}$ , $I_{OUT} = 300\text{ mA}$  | Room                 |                       | 20               |                  | mV                 |
| Dynamic Load Regulation                               | $\Delta V_{O(load)}$           | $I_{OUT} : 1\text{ mA}$ to $300\text{ mA}$ , $t_r/t_f = 2\ \mu\text{s}$  | Room                 |                       | 20               |                  |                    |
| Thermal Shutdown Junction Temperature                 | $T_{J(S/D)}$                   |  | Room                 |                       | 150              |                  | °C                 |
| Thermal Hysteresis                                    | $T_{HYST}$                     |  | Room                 |                       | 20               |                  |                    |
| Reverse current                                       | $I_R$                          | $V_{IN} = -6.0\text{ V}$   | Room                 |                       | 1                |                  | $\mu\text{A}$      |
| Short Circuit Current                                 | $I_{SC}$                       | $V_{OUT} = 0\text{ V}$   | Room                 |                       | 700              |                  | mA                 |
| <b>Shutdown</b>                                       |                                |  |                      |                       |                  |                  |                    |
| Shutdown Supply Current                               | $I_{CC(off)}$                  | $V_{SD} = 0\text{ V}$  | Room                 |                       | 0.1              | 1                | $\mu\text{A}$      |
| $\overline{\text{SD}}$ Pin Input Voltage              | $V_{SD}$                       | High = Regulator ON (Rising)   | Full                 | 1.5                   |                  | $V_{IN}$         | V                  |
|   |                                | Low = Regulator OFF (Falling)  | Full                 |                       |                  | 0.4              |                    |
| Auto Discharge Resistance                             | $R_{DIS}$                      |  | Room                 |                       | 100              |                  | $\Omega$           |
| $\overline{\text{SD}}$ Pin Input Current <sup>f</sup> | $I_{IN(SD)}$                   | $V_{SD} = 1.5\text{ V}$ , $V_{IN} = 6\text{ V}$  | Room                 |                       | 0.7              |                  | $\mu\text{A}$      |
| $\overline{\text{SD}}$ Hysteresis                     | $V_{HYST(SD)}$                 |  | Full                 |                       | 150              |                  | mV                 |
| $V_{OUT}$ Turn-On Time                                | $t_{ON}$                       | $V_{SD}$ (See Figure 1), $I_{LOAD} = 100\text{ nA}$  |                      |                       | 50               |                  | $\mu\text{s}$      |

**Notes**

- a. Room = 25°C, Full = -40 to 85°C.
- b. The algebraic convention whereby the most negative value is a minimum and the most positive a maximum.
- c. Typical values are for DESIGN AID ONLY, not guaranteed nor subject to production testing. Typical values for dropout voltage at  $V_{OUT} \geq 2\text{ V}$  are measured at  $V_{OUT} = 3.3\text{ V}$ , while typical values for dropout voltage at  $V_{OUT} < 2\text{ V}$  are measured at  $V_{OUT} = 1.8\text{ V}$ .
- d. Dropout voltage is defined as the input to output differential voltage at which the output voltage drops 2% below the output voltage measured with a 1-V differential, provided that  $V_{IN}$  does not drop below 2.0 V.
- e. Ground current is specified for normal operation as well as “drop-out” operation.
- f. The device’s shutdown pin includes a typical 2-M $\Omega$  internal pull-down resistor connected to ground.
- g.  $V_{OUT(nom)}$  is  $V_{OUT}$  when measured with a 1-V differential to  $V_{IN}$ .

**TIMING WAVEFORMS**

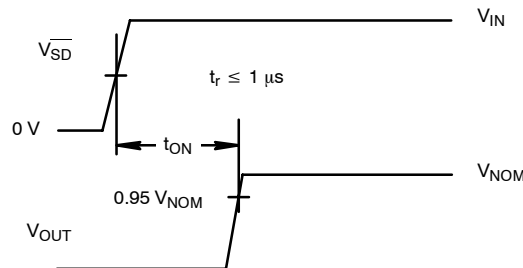

**FIGURE 1.** Timing Diagram for Power-Up

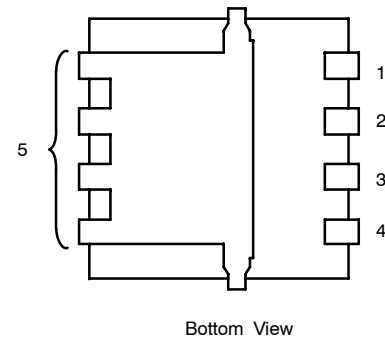
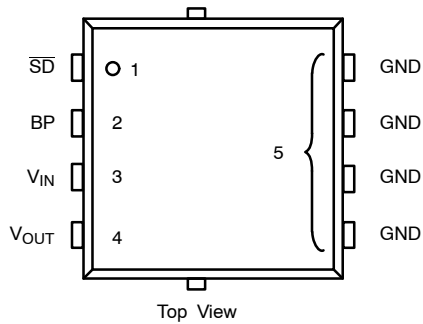
**PIN CONFIGURATION**
**MLP33-5 PowerPAK**

**PIN DESCRIPTION**

| Pin Number | Name            | Function  |
|------------|-----------------|---|
| 1          | $\overline{SD}$ | By applying less than 0.4 V to this pin, the device will be turned off. Connect this pin to $V_{IN}$ if unused                    |
| 2          | BP              | Noise bypass pin. For low noise applications, a 0.01 $\mu\text{F}$ ceramic capacitor should be connected from this pin to ground. |
| 3          | $V_{IN}$        | Input supply pin. Bypass this pin with a 1- $\mu\text{F}$ ceramic or tantalum capacitor to ground                                 |
| 4          | $V_{OUT}$       | Output voltage. Connect $C_{OUT}$ between this pin and ground.  |
| 5          | GND             | Ground pin. For better thermal capability, directly connected to large ground plane   |

**ORDERING INFORMATION**

| Standard Part Number | Lead (Pb)-Free Part Number | Marking | Voltage | Temp. Range | Pkg.    |
|----------------------|----------------------------|---------|---------|-------------|---------|
| Si91871DMP-12-T1     | Si91871DMP-12-E3           | 7112    | 1.2     | -40 to 85°C | MLP33-5 |
| Si91871DMP-18-T1     | Si91871DMP-18-E3           | 7118    | 1.8     |             |         |
| Si91871DMP-25-T1     | Si91871DMP-25-E3           | 7125    | 2.5     |             |         |
| Si91871DMP-26-T1     | Si91871DMP-26-E3           | 7126    | 2.6     |             |         |
| Si91871DMP-28-T1     | Si91871DMP-28-E3           | 7128    | 2.8     |             |         |
| Si91871DMP-30-T1     | Si91871DMP-30-E3           | 7130    | 3.0     |             |         |
| Si91871DMP-33-T1     | Si91871DMP-33-E3           | 7133    | 3.3     |             |         |
| Si91871DMP-50-T1     | Si91871DMP-50-E3           | 7150    | 5.0     |             |         |

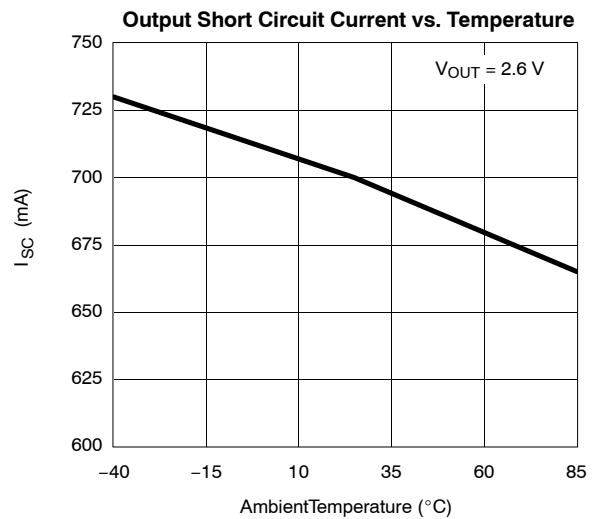
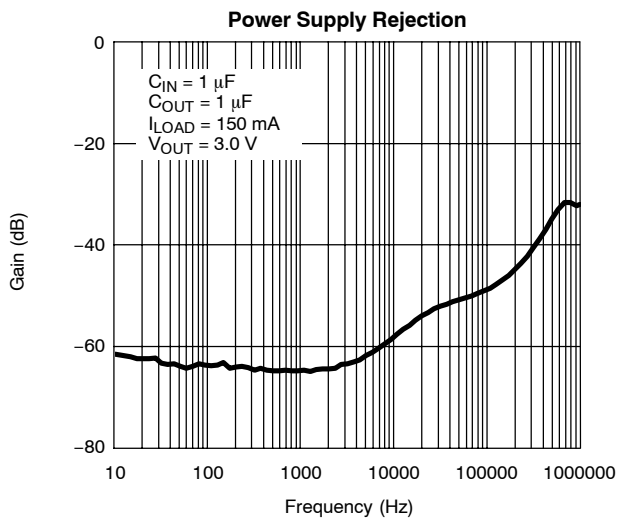
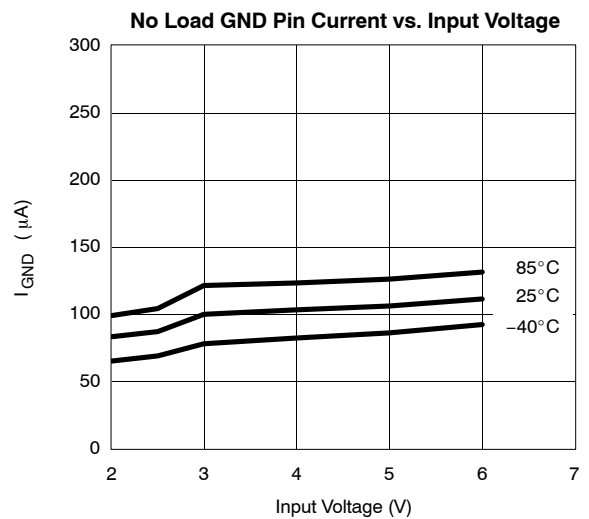
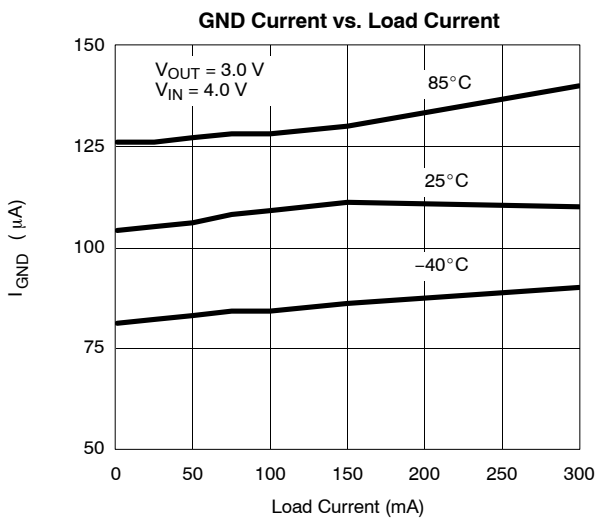
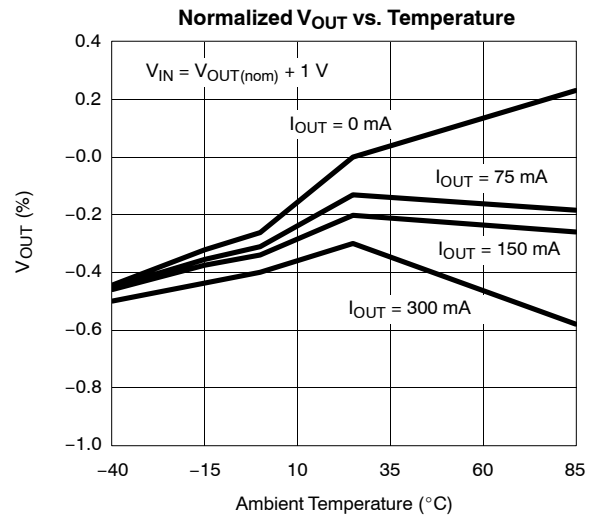
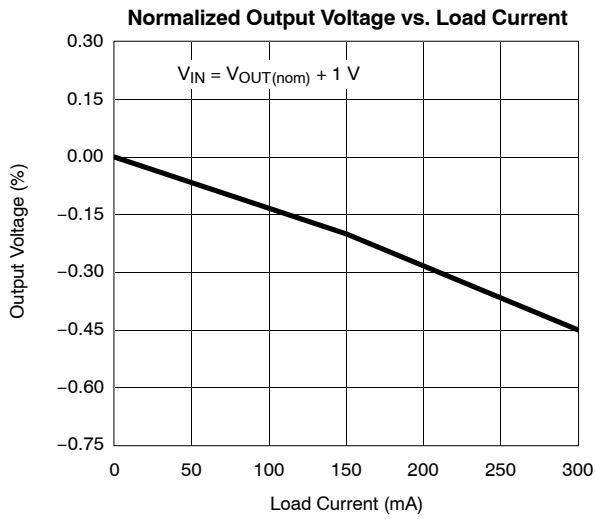
**TYPICAL CHARACTERISTICS (INTERNALLY REGULATED, 25°C UNLESS NOTED)**





**TYPICAL CHARACTERISTICS (INTERNALLY REGULATED, 25°C UNLESS NOTED)**

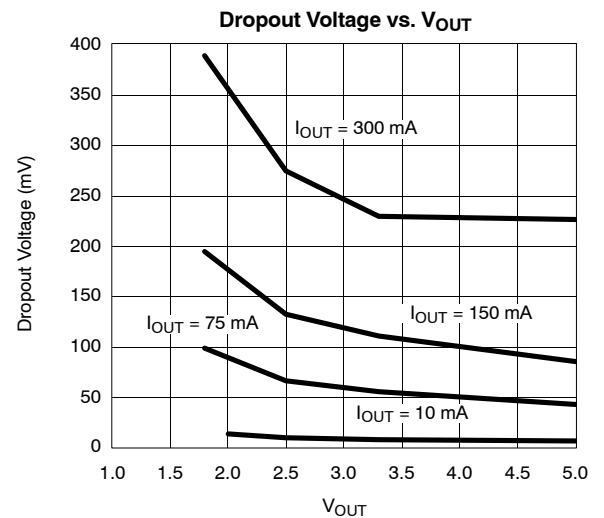
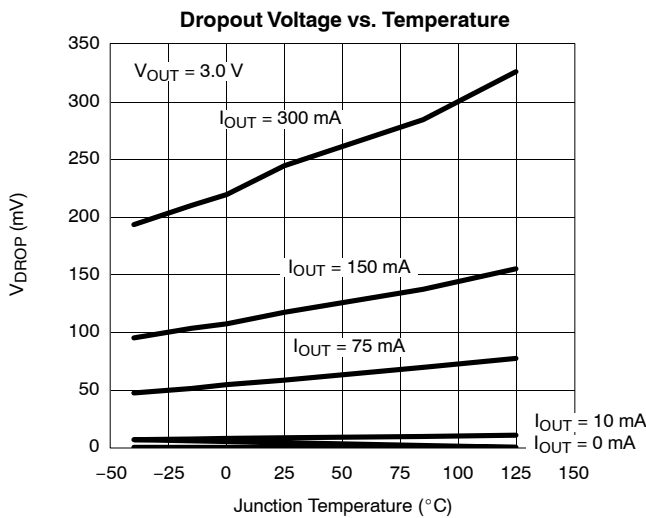
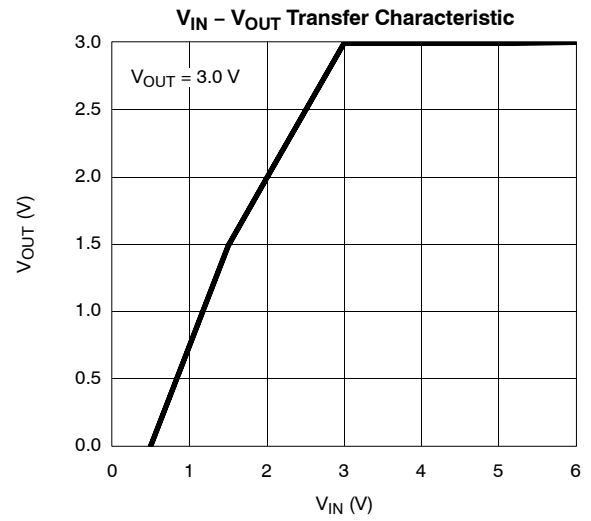
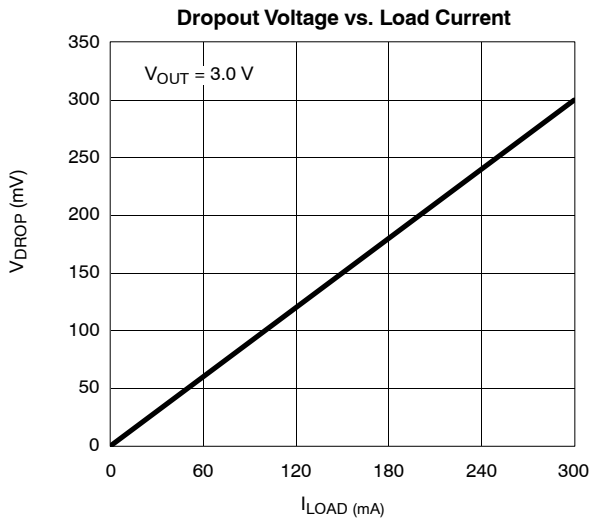

**TYPICAL WAVEFORMS**

**Load Transient Response-1**

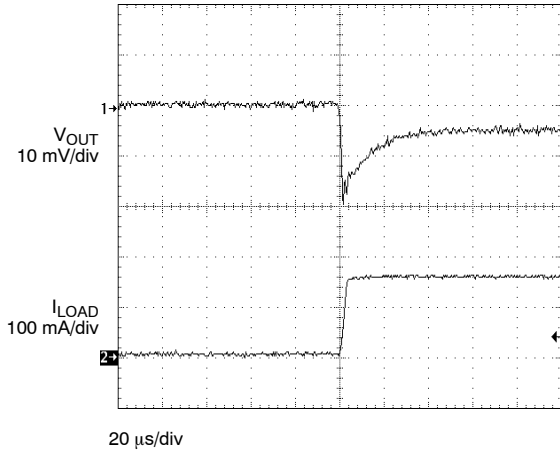

$V_{OUT} = 3.0\text{ V}$   
 $C_{OUT} = 1\ \mu\text{F}$   
 $I_{LOAD} = 1\ \text{to}\ 150\ \text{mA}$   
 $t_{rise} = 2\ \mu\text{sec}$

**Load Transient Response-2**

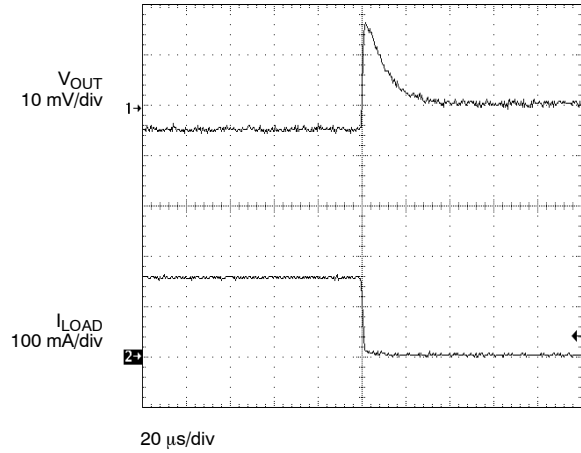

$V_{OUT} = 3.0\text{ V}$   
 $C_{OUT} = 1\ \mu\text{F}$   
 $I_{LOAD} = 150\ \text{to}\ 1\ \text{mA}$   
 $t_{fall} = 2\ \mu\text{sec}$

**Line Transient Response-1**

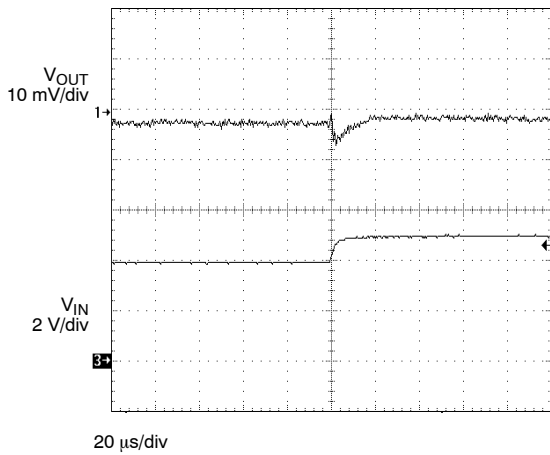

$V_{INSTEP} = 4\ \text{to}\ 5\ \text{V}$   
 $V_{OUT} = 3\ \text{V}$   
 $C_{OUT} = 1\ \mu\text{F}$   
 $C_{IN} = 1\ \mu\text{F}$   
 $I_{LOAD} = 150\ \text{mA}$   
 $t_{rise} = 5\ \mu\text{sec}$

**Line Transient Response-2**

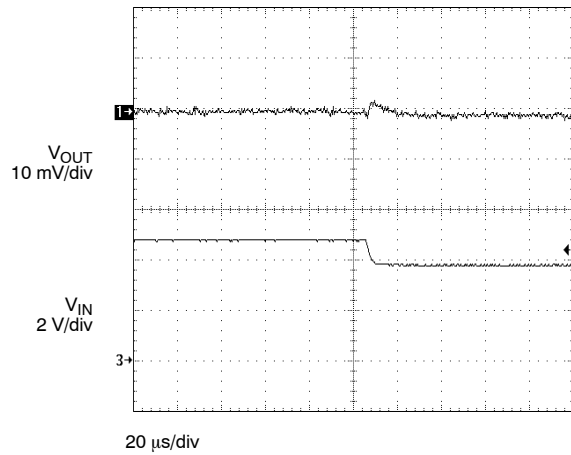

$V_{INSTEP} = 5\ \text{to}\ 4\ \text{V}$   
 $V_{OUT} = 3\ \text{V}$   
 $C_{OUT} = 1\ \mu\text{F}$   
 $C_{IN} = 1\ \mu\text{F}$   
 $I_{LOAD} = 150\ \text{mA}$   
 $t_{fall} = 5\ \mu\text{sec}$

**TYPICAL WAVEFORMS**

Output Noise

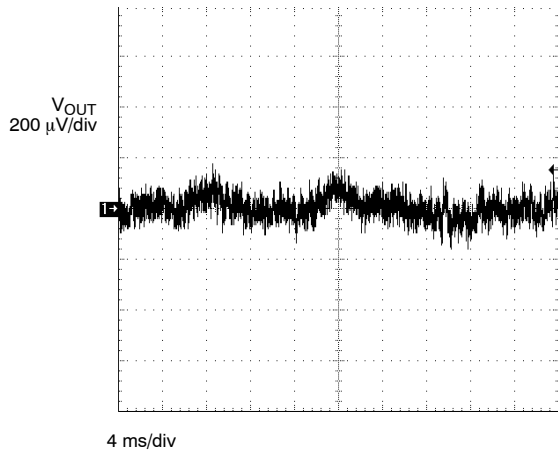

$V_{IN} = 4\text{ V}$   
 $V_{OUT} = 3\text{ V}$   
 $I_{LOAD} = 150\text{ mA}$   
 $C_{NOISE} = 0.01\text{ }\mu\text{F}$   
 $BW = 10\text{ Hz to }100\text{ kHz}$

Noise Spectrum

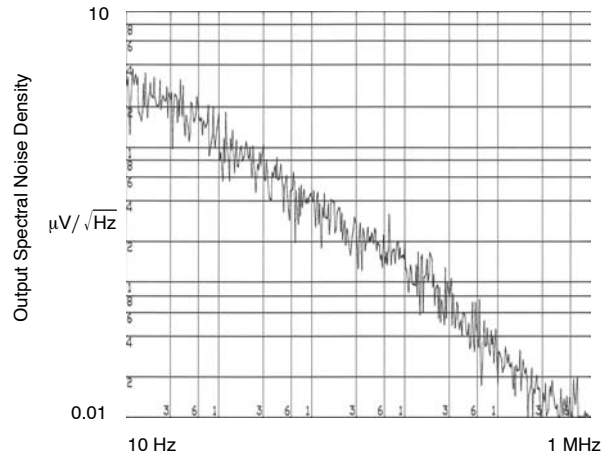

$V_{IN} = 4\text{ V}$   
 $V_{OUT} = 3\text{ V}$   
 $I_{LOAD} = 150\text{ mA}$   
 $C_{NOISE} = 0.01\text{ }\mu\text{F}$

**FUNCTIONAL BLOCK DIAGRAM**

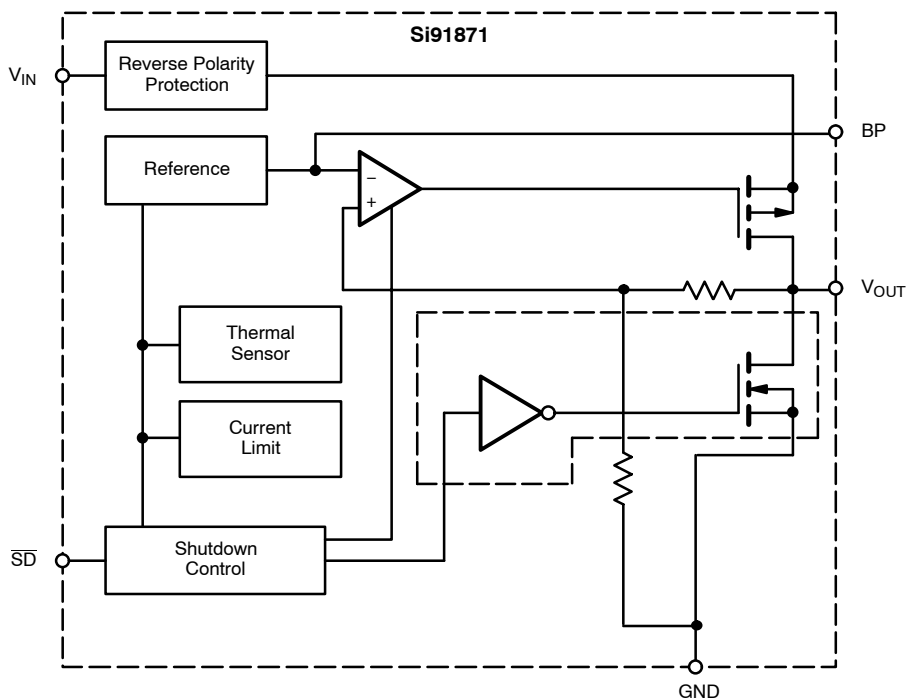



### DETAILED DESCRIPTION

The Si91871 is a low-noise, low drop-out and low quiescent current linear voltage regulator, packaged in a small footprint MLP33-5 package. The Si91871 can supply loads up to 300 mA. As shown in the block diagram, the circuit consists of a bandgap reference error, amplifier, p-channel pass transistor and feedback resistor string. An external bypass capacitor connected to the BP pin reduces noise at the output. Additional blocks, not shown in the block diagram, include a precise current limiter, reverse battery and current protection and thermal sensor.

#### Thermal Overload Protection

The thermal overload protection limits the total power dissipation and protects the device from being damaged. When the junction temperature exceeds 150°C, the device turns the p-channel pass transistor off.

#### Reverse Battery Protection

The Si91871 has a battery reverse protection circuitry that disconnects the internal circuitry when  $V_{IN}$  drops below the GND voltage. There is no current drawn in such an event. When the  $\overline{SD}$  pin is hardwired to  $V_{IN}$ , the user must connect the  $\overline{SD}$  pin to  $V_{IN}$  via a 100-k $\Omega$  resistor if reverse battery protection is desired. Hardwiring the  $\overline{SD}$  pin directly to the  $V_{IN}$  pin is allowed when reverse battery protection is not desired.

#### Noise Reduction

An external 10-nF bypass capacitor at BP is used to create a low pass filter for noise reduction. The start-up time is fast, since a power-on circuit pre-charges the bypass capacitor. After the power-up sequence the pre-charge circuit is switched to standby mode in order to save current. It is therefore not recommended to use larger bypass capacitor values than 50 nF. When the circuit is used without a capacitor, stable operation is guaranteed.

#### Auto-Discharge

The Si91871  $V_{OUT}$  has an internal 100- $\Omega$  (typ.) discharge path to ground when the  $\overline{SD}$  pin is low.

#### Stability

The circuit is stable with only a small output capacitor equal to 6 nF/mA (= 2  $\mu$ F @ 300 mA). Since the bandwidth of the error amplifier is around 1–3 MHz and the dominant pole is at the output node, the capacitor should be capacitive in this range, i.e., for 150-mA load current, an ESR <0.2  $\Omega$  is necessary. Parasitic inductance of about 10 nH can be tolerated.

#### Safe Operating Area

The ability of the Si91871 to supply current is ultimately dependent on the junction temperature of the pass device. Junction temperature is in turn dependent on power

dissipation in the pass device, the thermal resistance of the package and the circuit board, and the ambient temperature. The power dissipation is defined as

$$P_D = (V_{IN} - V_{OUT}) * I_{OUT}$$

Junction temperature is defined as

$$T_J = T_A + ((P_D * (R_{\theta JC} + R_{\theta CA})))$$

To calculate the limits of performance, these equations must be rewritten.

Allowable power dissipation is calculated using the equation

$$P_D = (T_J - T_A) / (R_{\theta JC} + R_{\theta CA})$$

While allowable output current is calculated using the equation

$$I_{OUT} = (T_J - T_A) / (R_{\theta JC} + R_{\theta CA}) * (V_{IN} - V_{OUT})$$

Ratings of the Si91871 that must be observed are

$$T_{Jmax} = 125 \text{ }^\circ\text{C}, T_{Amax} = 85 \text{ }^\circ\text{C}, (V_{IN} - V_{OUT})_{max} = 5.3 \text{ V}, R_{\theta JC} = 8 \text{ }^\circ\text{C/W}$$

The value of  $R_{\theta CA}$  is dependent on the PC board used. The value of  $R_{\theta CA}$  for the board used in device characterization is approximately 46  $^\circ\text{C/W}$ .

Figure 1 shows the performance limits graphically for the Si91871 mounted on the circuit board used for thermal characterization.

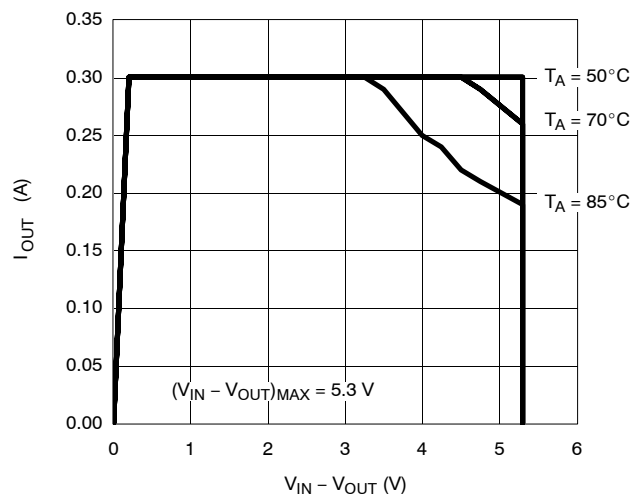

**Figure 1.** Safe Operating Area

Vishay Siliconix maintains worldwide manufacturing capability. Products may be manufactured at one of several qualified locations. Reliability data for Silicon Technology and Package Reliability represent a composite of all qualified locations. For related documents such as package/tape drawings, part marking, and reliability data, see <http://www.vishay.com/ppg?72012>.



## Notice

Specifications of the products displayed herein are subject to change without notice. Vishay Intertechnology, Inc., or anyone on its behalf, assumes no responsibility or liability for any errors or inaccuracies.

Information contained herein is intended to provide a product description only. No license, express or implied, by estoppel or otherwise, to any intellectual property rights is granted by this document. Except as provided in Vishay's terms and conditions of sale for such products, Vishay assumes no liability whatsoever, and disclaims any express or implied warranty, relating to sale and/or use of Vishay products including liability or warranties relating to fitness for a particular purpose, merchantability, or infringement of any patent, copyright, or other intellectual property right.

The products shown herein are not designed for use in medical, life-saving, or life-sustaining applications. Customers using or selling these products for use in such applications do so at their own risk and agree to fully indemnify Vishay for any damages resulting from such improper use or sale.