

RT3TSSM

Composite Transistor With Resistor
For Switching Application
Silicon Epitaxial Type

DESCRIPTION

RT3TSSM is a composite transistor built with RT1N150 chip and RT1P150 chip in SC-88 package.

FEATURE

- Silicon epitaxial type
- Each transistor elements are independent.
- Mini package for easy mounting

APPLICATION

- Inverted circuit, switching circuit,
- interface circuit, driver circuit

※PNP built in transistor of "—" sign is abbreviation.

OUTLINE DRAWING

Unit: mm

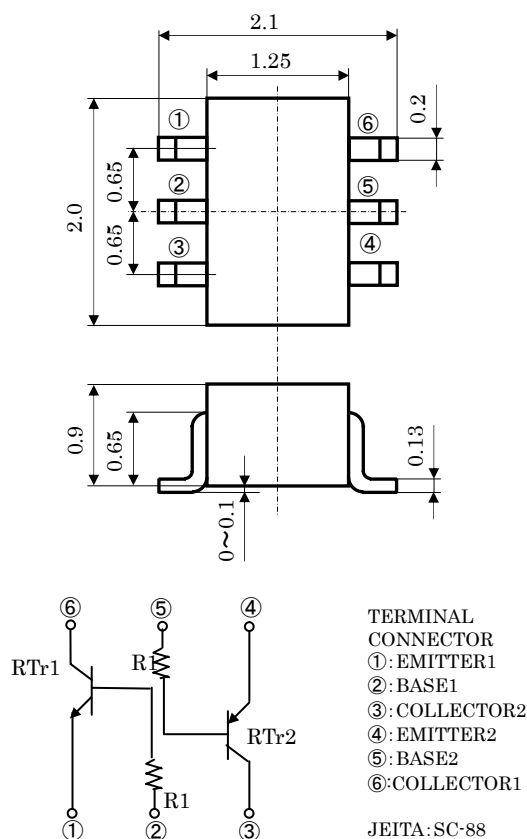

MAXIMUM RATING (Ta=25°C)

SYMBOL	PARAMETER	RATING	UNIT
VCBO	Collector to Base voltage	50	V
VEBO	Emitter to Base voltage	6	V
VCEO	Collector to Emitter voltage	50	V
IC	Collector current	100	mA
ICM	Peak Collector current	200	mA
PC	Collector dissipation (Total, Ta=25°C)	150	mW
Tj	Junction temperature	+150	°C
Tstg	Storage temperature	-55 ~ +150	°C

MARKING

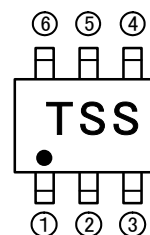

RT3TSSM

Composite Transistor With Resistor
For Switching Application
Silicon Epitaxial Type

ELECTRICAL CHARACTERISTICS (Ta=25°C)

Symbol	Parameter	Test conditions	Limits			Unit	
			Min	Typ	Max		
V(BR)CEO	Collector to Emitter break down voltage	IC=100 μA, RBE=∞	50	-	-	V	
ICBO	Collector cut off current	VCB=50V, IE=0	-	-	0.1	μA	
hFE	DC forward current gain	VCE=5V, IC=1mA	100	-	-	-	
VCE(sat)	Collector to Emitter saturation voltage	IC=1mA, IB=0.1mA	-	0.1	0.3	V	
R1	Input resistor	-	-	100	-	kΩ	
fT	Gain band width product	VCE=6V, IE=10mA	Tr1	-	200	-	MHz
			Tr2	-	150	-	

TYPICAL CHARACTERISTICS (Tr1)

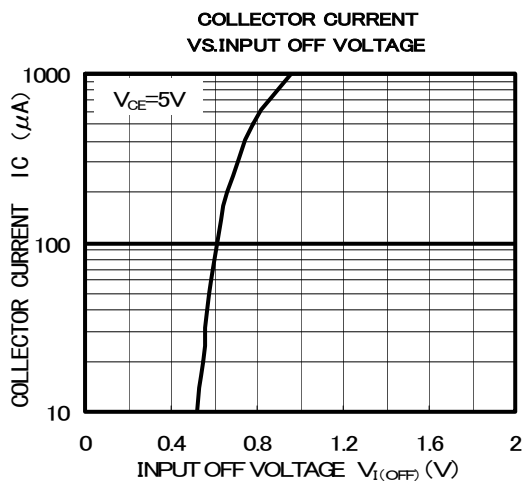
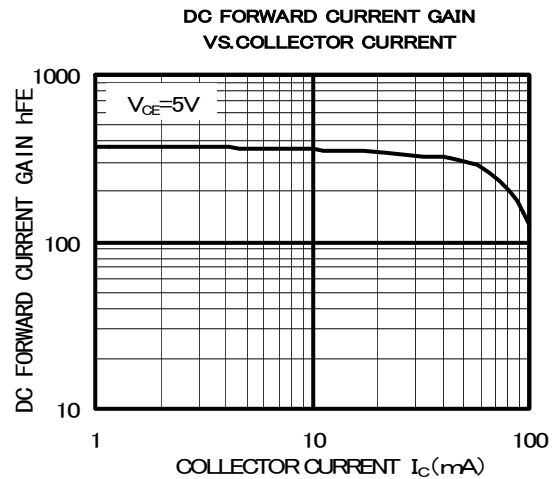
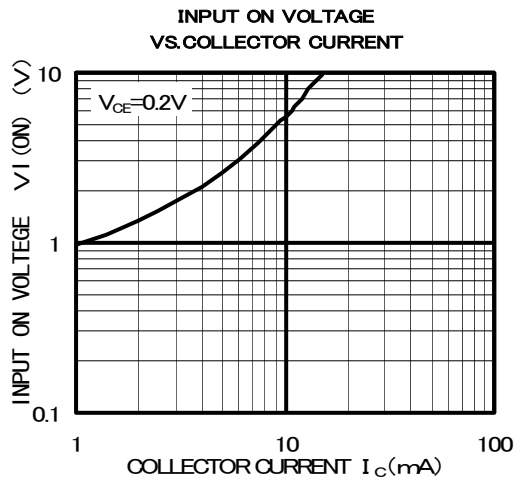

RT3TSSM

Composite Transistor With Resistor
For Switching Application
Silicon Epitaxial Type

TYPICAL CHARACTERISTICS (Tr2)

DC forward current gain-Collector current

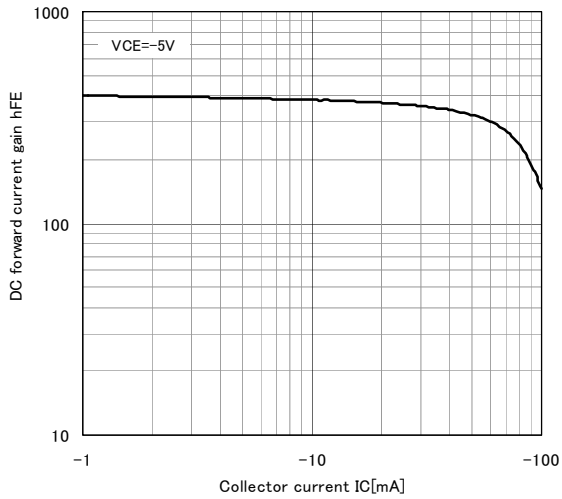

Collector current-Input off voltage

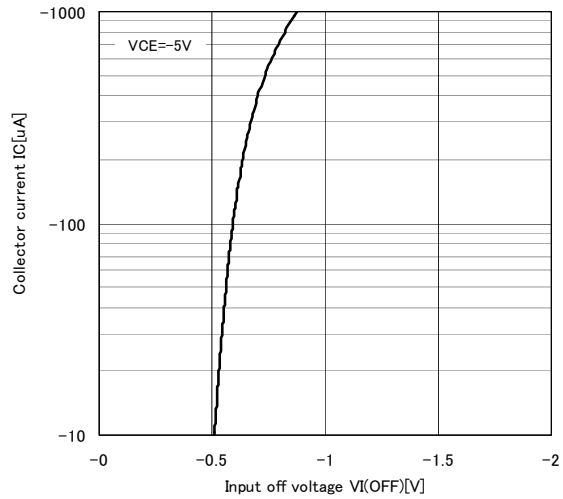

Input on voltage-Collector current

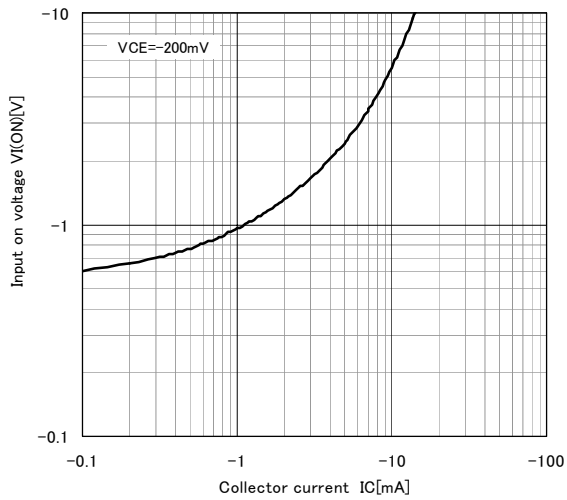



Marketing division, Marketing planning department

6-41 Tsukuba, Isahaya, Nagasaki, 854-0065 Japan

Keep safety first in your circuit designs!

•ISAHAYA Electronics Corporation puts the maximum effort into making semiconductor products better and more reliable, but there is always the possibility that trouble may occur with them. Trouble with semiconductors may lead to personal injury, fire or property damage. Remember to give due consideration to safety when making your circuit designs, with appropriate measures such as (1) placement of substitutive, auxiliary, (2) use of non-flammable material or (3) prevention against any malfunction or mishap.

Notes regarding these materials

- These materials are intended as a reference to our customers in the selection of the ISAHAYA products best suited to the customer's application; they don't convey any license under any intellectual property rights, or any other rights, belonging ISAHAYA or third party.
- ISAHAYA Electronics Corporation assumes no responsibility for any damage, or infringement of any third party's rights, originating in the use of any product data, diagrams, charts or circuit application examples contained in these materials.
- All information contained in these materials, including product data, diagrams and charts, represent information on products at the time of publication of these materials, and are subject to change by ISAHAYA Electronics Corporation without notice due to product improvements or other reasons. It is therefore recommended that customers contact ISAHAYA Electronics Corporation or an authorized ISAHAYA products distributor for the latest product information before purchasing product listed herein.
- ISAHAYA Electronics Corporation products are not designed or manufactured for use in a device or system that is used under circumstances in which human life is potentially at stake. Please contact ISAHAYA electronics corporation or an authorized ISAHAYA products distributor when considering the use of a product contained herein for any specific purposes, such as apparatus or systems for transportation, vehicular, medical, aerospace, nuclear, or undersea repeater use.
- The prior written approval of ISAHAYA Electronics Corporation is necessary to reprint or reproduce in whole or in part these materials.
- If these products or technologies are subject to the Japanese export control restrictions, they must be exported under a license from the Japanese government and cannot be imported into a country other than the approved destination. Any diversion or re-export contrary to the export control laws and regulations of Japan and/or the country of destination is prohibited.
- Please contact ISAHAYA Electronics Corporation or authorized ISAHAYA products distributor for further details on these materials or the products contained therein.