

ML6204 Series - High Speed LDO Regulators

(low ESR capacitor compatible, ON/OFF switch)

- **CMOS Low Power Consumption**
- **Dropout Voltage:** 60mV @ 30mA,
200mV @ 100mA
- **Maximum Output Current:**
150mA
- **Highly Accurate:** 1.5V ~ 1.95V ± 3%
2.0V ~ 6.00V ± 2%
- **Output Voltage Range:** 1.5V ~ 6.0V
- **Low ESR capacitor compatible**

◆ General Description

The ML6204 series are highly precise, low noise, positive voltage LDO regulators manufactured using CMOS process. The series achieves high ripple rejection and low dropout and consists of a standard voltage source, an error correction, current limiter and a phase compensation circuit plus a driver transistor. Output voltage is selectable in 50mV increments within a range of 1.5V ~ 6.0V.

The series is also compatible with low ESR ceramic capacitors which give added output stability. This stability can be maintained even during load fluctuations due to the excellent transient response of the series. The CE function enables the output to be turned off, resulting in greatly reduced power consumption.

◆ Typical Application

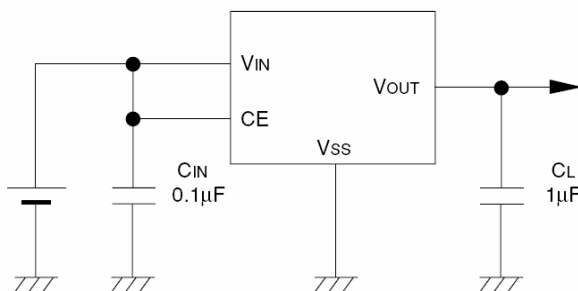

◆ Applications

- Mobile phones
- Cordless phones
- Cameras, video recorders
- Portable games
- Portable AV equipment
- Reference voltage
- Battery-powered equipment

◆ Features

Maximum Output Current: 150mA

Dropout Voltage: 200mV (IOUT = 100mA)

Maximum Operating Voltage: 10V

Output Voltage Range: 1.5V ~ 6.0V in 50mV increments

Highly Accurate: ± 2%

Low Power Consumption: TYP 70µA

Standby Current: less than 0.1µA

High Ripple Rejection: 70dB (10 kHz)

Low Output Noise: 30µVrms

Operational Temperature Range: -40°C ~ +85°C

Low ESR Capacitor Compatible: Ceramic capacitor

◆ Pin Assignment

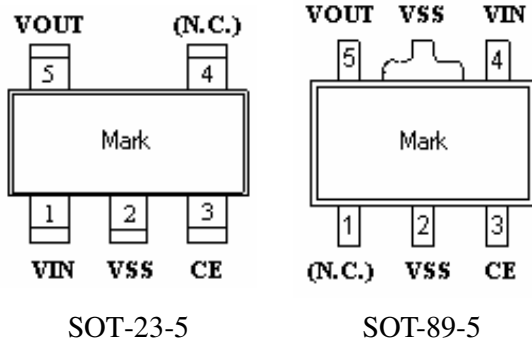

◆ Pin Function

Pin No.		Pin Name	Description
SOT-23-5	SOT-89-5		
1	4	VIN	Input
2	2	VSS	Ground
3	3	CE	ON/OFF Control
4	1	N.C.	No Connection
5	5	VOUT	Output

◆ Product Classification

● Selection Guide

The following options for the CE pin logic and internal pull-up/down are available:

- Active 'High' + no pull-down resistor built-in (standard)
- Active 'High' + 800k Ω pull-down resistor built-in <between CE-VSS> (semi-custom)
- Active 'Low' + no pull-up resistor built-in (semi-custom)
- Active 'Low' + 800k Ω pull-up resistor built-in <between CE-VSS> (semi-custom)

Note: *With the pull-up resistor or pull-down resistor built-in types, the supply current during operation will increase by VIN / 800k Ω (TYP.)

● Ordering Information

ML6204①②③④⑤⑥⑦

Designator	Symbol	Description
①	A	Active "High" (pull-down resistor built in)
	B	Active "High" (no pull-down resistor built in)
	C	Active "Low" (pull-up resistor built in)
	D	Active "Low" (no pull-up resistor built in)
②③	15 ~ 60	Output Voltage: e.g. 20 \Rightarrow 2.0V, 30 \Rightarrow 3.0V etc.
④	2	Output Voltage: 100mV increments, $\pm 2\%$ accuracy e.g. ②=3, ③=8, ④=2 \Rightarrow 3.8V, $\pm 2\%$
	A	Output Voltage: 50mV increments, $\pm 2\%$ accuracy e.g. ②=3, ③=8, ④=A \Rightarrow 3.85V, $\pm 2\%$
⑤	M	SOT-23-5 Package
	P	SOT-89-5 Package
⑥	R	Embossed Tape: Standard Feed
	L	Embossed Tape: Reverse Feed
⑦	G	Lead-free Package

Please note that "B" version is the standard part while the A, C and D are semi-custom parts.

◆ Marking Information

- SOT-23-5

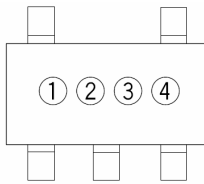

(TOP VIEW)

① represents the product name

Designator	Product Name
P	ML6204*****

- SOT-89-5

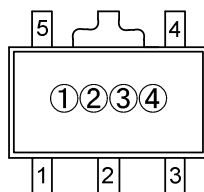

(TOP VIEW)

② represents the integer part of the output voltage

Designator	Output voltage (V)
1	1.0
2	2.0
3	3.0
4	4.0
5	5.0
6	6.0

③ represents the decimal part of the output voltage

Designator	Output Voltage (V)	Designator	Output voltage (V)
0	0.0	A	0.05
1	0.1	B	0.15
2	0.2	C	0.25
3	0.3	D	0.35
4	0.4	E	0.45
5	0.5	F	0.55
6	0.6	G	0.65
7	0.7	H	0.75
8	0.8	I	0.85
9	0.9	J	0.95

e.g. ②③=12 ⇒ 1.20V and ②③=1C ⇒ 1.25V.

④ represents the resistor version

Designator	Resistor Version
A	Active “High” (pull-down resistor built in)
B	Active “High” (no pull-down resistor built in)
C	Active “Low” (pull-up resistor built in)
D	Active “Low” (no pull-up resistor built in)

◆ Package Information

- SOT-23-5

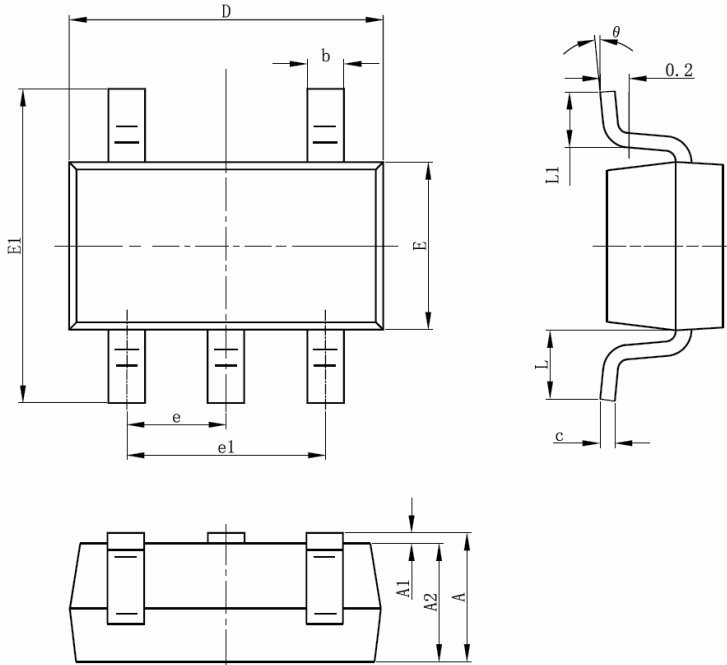

Symbol	Dimensions In Millimeters		Dimensions In Inches	
	Min	Max	Min	Max
A	1.050	1.250	0.041	0.049
A1	0.000	0.100	0.000	0.004
A2	1.050	1.150	0.041	0.045
b	0.300	0.400	0.012	0.016
c	0.100	0.200	0.004	0.008
D	2.820	3.020	0.111	0.119
E	1.500	1.700	0.059	0.067
E1	2.650	2.950	0.104	0.116
e	0.950TYP		0.037TYP	
e1	1.800	2.000	0.071	0.079
L	0.700REF		0.028REF	
L1	0.300	0.600	0.012	0.024
θ	0°	8°	0°	8°

◆ Package Information

- SOT-89-5

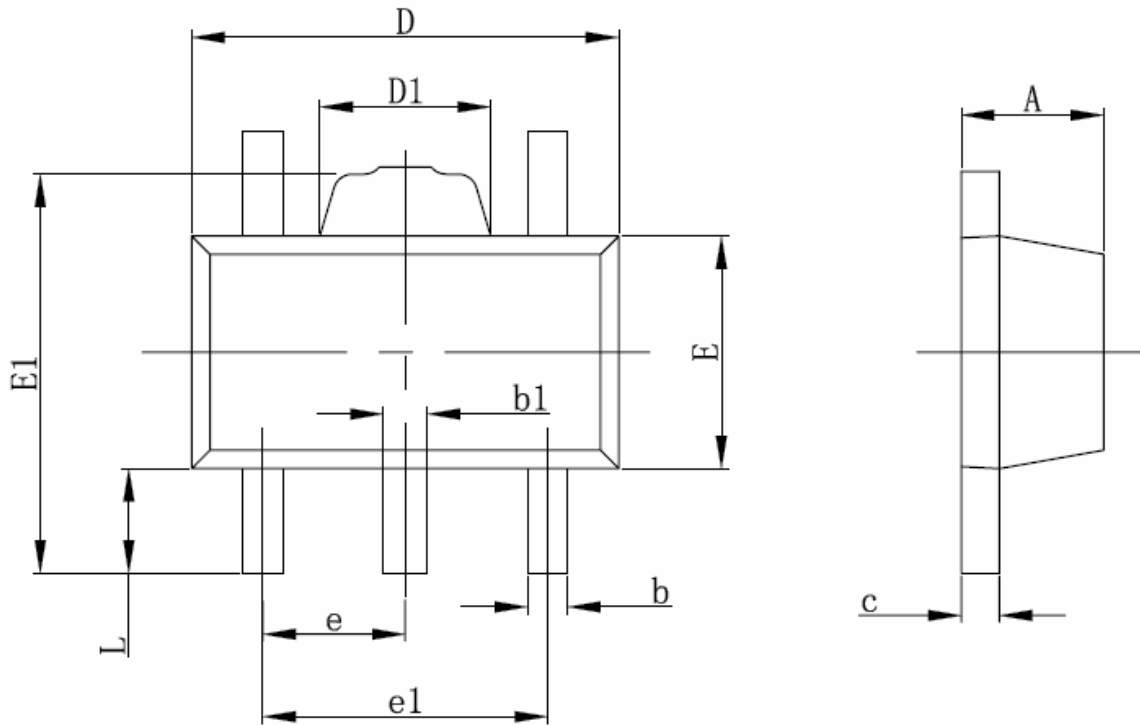

Symbol	Dimensions In Millimeters		Dimensions In Inches	
	Min	Max	Min	Max
A	1.400	1.600	0.055	0.063
b	0.320	0.520	0.013	0.020
b1	0.360	0.560	0.014	0.022
c	0.350	0.440	0.014	0.017
D	4.400	4.600	0.173	0.181
D1	1.400	1.800	0.055	0.071
E	2.300	2.600	0.091	0.102
E1	3.940	4.250	0.155	0.167
e	1.500TYP		0.060TYP	
e1	2.900	3.100	0.114	0.122
L	0.900	1.100	0.035	0.043

◆ **Block Diagram**

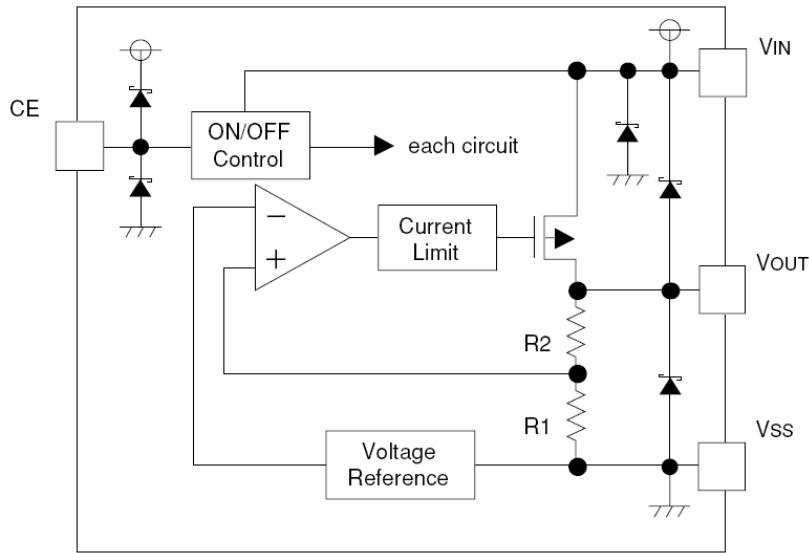

The diodes in the circuit above are the protective diodes.

◆ **Absolute Maximum Ratings**

Parameter	Symbol	Ratings	Units
Input Voltage	VIN	10	V
Output Current	IOUT	400	mA
Output Voltage	VOUT	VSS-0.3 ~ VIN+0.3	V
Power Dissipation SOT25	Pd	250	mW
Operation Ambient Temperature	Topr	-40 ~ +70	°C
Storage Temperature	Tstg	-55 ~ +80	°C

* IOUT= the range of Pd/ (VIN-VOUT)



◆ Electrical Characteristics

ML6204A, B Series

Parameter	Symbol	Conditions	Ta=25°C			-40°C ≤ Ta ≤ 85°C			Units	Circuit
			Min	Typ	Max	Min	Typ	Max		
Output Voltage	V _{OUT(E)}	I _{OUT} = 30mA, 1.5V ≤ V _{OUT(T)} ≤ 1.95V	X0.97	V _{OUT(T)}	X1.03	X0.96	V _{OUT(T)}	X1.04	V	1
		I _{OUT} = 30mA, 2.0V ≤ V _{OUT(T)} ≤ 6.0V	X0.98	V _{OUT(T)}	X1.02	X0.97	V _{OUT(T)}	X1.03		
Maximum Output Current	I _{OUT MAX}		150			150			mA	1
Load Regulation	ΔV _{OUT}	1mA ≤ I _{OUT} ≤ 100mA		15	50		30	80	mV	1
Dropout Voltage	V _{dif1}	I _{OUT} = 30mA	E-1						mV	1
	V _{dif2}	I _{OUT} = 100mA	E-2							
Supply Current (A series)	I _{DD}	V _{IN} = V _{CE} = V _{OUT(T)} + 1.0V	20	80	120	20	90	145	μA	2
Supply Current (B series)		V _{IN} = V _{CE} = V _{OUT(T)} + 1.0V	20	70	100	20	80	120		
Standby Current	I _{stby}	V _{IN} = V _{OUT(T)} + 1.0V, V _{CE} = V _{SS}		0.01	0.10		0.05	1.00	μA	2
Line Regulation	$\frac{\Delta V_{OUT}}{\Delta V_{IN} - V_{OUT}}$	V _{OUT(T)} + 1.0V ≤ V _{IN} ≤ 10V I _{OUT} = 30mA		0.01	0.20		0.05	0.30	%/V	1
Input Voltage	V _{IN}		2		10	2		10	V	--
Output Voltage Temp. Characteristics	$\frac{\Delta V_{OUT}}{\Delta T_{opr} - V_{OUT}}$	I _{OUT} = 30mA -40°C ≤ T _{opr} ≤ 85°C		100					Ppm/°C	1
Output Noise	e _n	I _{OUT} = 10mA 300Hz ~ 50kHz		30					μV _{rms}	3
Ripple Rejection Rate	PSRR	V _{IN} = [V _{OUT(T)} + 1.0]V + 1.0V _{p-pAC} I _{OUT} = 50mA, f = 10kHz		70					dB	4
Current Limited	I _{Ilim}	V _{IN} = V _{OUT(T)} + 1.0V, V _{CE} = V _{IN}		300			280		mA	1
Short-circuit Current	I _{short}	V _{IN} = V _{OUT(T)} + 1.0V, V _{CE} = V _{IN}		50			60		mA	1
CE "High" Voltage	V _{CEH}		1.6		V _{IN}	1.7		V _{IN}	V	1
CE "Low" Voltage	V _{CEL}				0.25		0.20		V	1
CE "High" Current (A series)	I _{CEH}	V _{IN} = V _{CE} = V _{OUT(T)} + 1.0V	-0.10		20	-0.15		25	μA	2
CE "High" Current (B series)	I _{CEH}	V _{IN} = V _{CE} = V _{OUT(T)} + 1.0V	-0.10		0.10	-0.15		0.15	μA	2
CE "Low" Current	I _{CEL}	V _{IN} = V _{OUT(T)} + 1.0V, V _{CE} = V _{SS}	-0.10		0.10	-0.15		0.15	μA	2

Note

(NOTE 1) Unless otherwise stated, V_{IN} = V_{OUT(T)} + 1.0V

(NOTE 2) V_{OUT(T)} = Specified Output Voltage

(NOTE 3) V_{OUT(E)} = Effective Output Voltage (I.e. the output voltage when "V_{OUT(T)} + 1.0V" is provided at the V_{IN} pin while maintaining a certain I_{OUT} value)

(NOTE 4) V_{dif} = (V_{IN1} (NOTE6) - V_{OUT1} (NOTES))

(NOTE 5) V_{OUT1} = A voltage equal to 98% of the Output Voltage whenever an amply stabilized I_{OUT} (V_{OUT(T)} + 1.0V) is input.

(NOTE 6) V_{IN1} = The Input Voltage when V_{OUT1} appears as Input Voltage is gradually decreased.

(NOTE 7) The values for -40°C ≤ T_{opr} ≤ 85°C are designed values.



ML6204C, D Series

Parameter	Symbol	Conditions	Ta=25°C			-40°C ≤ Ta ≤ 85°C			Units	Circuit
			Min	Typ	Max	Min	Typ	Max		
Output Voltage	VOUT(E)	IOUT = 30mA, 1.5V ≤ VOUT(T) ≤ 1.95V	X0.97	VOUT(T)	X1.03	X0.96	VOUT(T)	X1.04	V	1
		IOUT = 30mA, 2.0V ≤ VOUT(T) ≤ 6.0V	X0.98	VOUT(T)	X1.02	X0.97	VOUT(T)	X1.03		
Maximum Output Current	IOUT MAX		150			150			mA	1
Load Regulation	ΔVOUT	1mA ≤ IOUT ≤ 100mA		15	50		30	80	mV	1
Dropout Voltage	Vdif1	IOUT = 30mA	E-1						mV	1
	Vdif2	IOUT = 100mA	E-2						mV	
Supply Current (C series)	IDD	VIN = VOUT(T) + 1.0V, VCE = VSS	20	80	120	20	90	145	μA	2
Supply Current (B series)		VIN = VOUT(T) + 1.0V, VCE = VSS	20	70	100	20	80	120		
Standby Current	Istby	VIN = VCE = VOUT(T) + 1.0V		0.01	0.10		0.05	1.00	μA	2
Line Regulation	$\frac{\Delta V_{OUT}}{\Delta V_{IN} - V_{OUT}}$	VOUT(T) + 1.0V ≤ VIN ≤ 10V IOUT = 30mA		0.01	0.20		0.05	0.30	%/V	1
Input Voltage	VIN		2		10	2		10	V	--
Output Voltage Temp. Characteristics	$\frac{\Delta V_{OUT}}{\Delta T_{opr} - V_{OUT}}$	IOUT = 30mA -40°C ≤ Topr ≤ 85°C		100					Ppm/°C	1
Output Noise	en	IOUT = 10mA 300Hz ~ 50kHz		30					μVrms	3
Ripple Rejection Rate	PSRR	VIN = [VOUT(T) + 1.0]V + 1.0Vp-pAC IOUT = 50mA, f = 10kHz		70					dB	4
Current Limited	Ilim	VIN = VOUT(T) + 1.0V, VCE = VSS		300			280		mA	1
Short-circuit Current	Ishort	VIN = VOUT(T) + 1.0V, VCE = VSS		50			60		mA	1
CE "High" Voltage	VCEH		1.6		VIN	1.7		VIN	V	1
CE "Low" Voltage	VCEL				0.25			0.20	V	1
CE "High" Current	ICEH	VIN = VCE = VOUT(T) + 1.0V	-0.10		0.10	-0.15		0.15	μA	2
CE "Low" Current (C series)	ICEL	VIN = VOUT(T) + 1.0V, VCE = VSS	-20		0.10	-25		0.15	μA	2
CE "Low" Current (D series)	ICEL	VIN = VOUT(T) + 1.0V, VCE = VSS	-0.10		0.10	-0.15		0.15	μA	2

Note

(NOTE 1) Unless otherwise stated, VIN = VOUT(T) + 1.0V

(NOTE 2) VOUT(T) = Specified Output Voltage

(NOTE 3) VOUT(E) = Effective Output Voltage (I.e. the output voltage when "VOUT(T) + 1.0V" is provided at the VIN pin while maintaining a certain IOUT value)

(NOTE 4) Vdif = (VIN1 (NOTE6) - VOUT1 (NOTES))

(NOTE 5) VOUT1 = A voltage equal to 98% of the Output Voltage whenever an amply stabilized IOUT (VOUT(T) + 1.0V) is input.

(NOTE 6) VIN1 = The Input Voltage when VOUT1 appears as Input Voltage is gradually decreased.

(NOTE 7) The values for -40°C ≤ Topr ≤ 85°C are designed values.



Dropout Voltage – Table 1

SYMBOL	E-0		E-1				E-2			
PARAMETER OUTPUT VOLTAGE	Output Voltage (V)		Dropout Voltage 1 (mV) <i>(I_{OUT}=30mA)</i>				Dropout Voltage 2 (mV) <i>(I_{OUT}=100mA)</i>			
			<i>T_a=25°C</i>		<i>-40°C ≤ T_{opr} ≤ 85°C</i>		<i>T_a=25°C</i>		<i>-40°C ≤ T_{opr} ≤ 85°C</i>	
V_{OUT}(T)	V_{OUT}		V_{dif1}	V_{dif1}	V_{dif1}	V_{dif1}	V_{dif2}	V_{dif2}	V_{dif2}	V_{dif2}
	MIN	MAX	TYP	MAX	TYP	MAX	TYP	MAX	TYP	MAX
1.50	1.455	1.545	400	500	410	520	600	800	620	820
1.55	1.504	1.597	400	500	410	520	600	800	620	820
1.60	1.552	1.648	300	380	310	400	500	680	520	700
1.65	1.601	1.700	300	380	310	400	500	680	520	700
1.70	1.649	1.751	250	320	260	330	400	620	420	640
1.75	1.698	1.803	250	320	260	330	400	620	420	640
1.80	1.746	1.854	200	250	210	260	350	480	360	500
1.85	1.795	1.906	200	250	210	260	350	480	360	500
1.90	1.843	1.957	140	180	150	190	320	460	340	480
1.95	1.892	2.009	140	180	150	190	320	460	340	480
2.00	1.960	2.040	100	150	110	160	270	420	290	440
2.05	2.009	2.091	100	150	110	160	270	420	290	440
2.10	2.058	2.142	100	150	110	160	250	400	280	410
2.15	2.107	2.193	100	150	110	160	250	400	280	410
2.20	2.156	2.244	100	150	110	160	250	400	280	410
2.25	2.205	2.295	100	150	110	160	250	400	280	410
2.30	2.254	2.346	100	150	110	160	240	380	280	400
2.35	2.303	2.397	100	150	110	160	240	380	280	400
2.40	2.352	2.448	100	150	110	160	240	380	280	400
2.45	2.401	2.499	100	150	110	160	240	380	280	400
2.50	2.450	2.550	90	120	100	130	230	350	260	380
2.55	2.499	2.601	90	120	100	130	230	350	260	380
2.60	2.548	2.652	90	120	100	130	230	350	260	380
2.65	2.597	2.703	90	120	100	130	230	350	260	380
2.70	2.646	2.754	90	120	100	130	230	350	260	380
2.75	2.695	2.805	90	120	100	130	230	350	260	380
2.80	2.744	2.856	90	120	100	130	220	330	260	370
2.85	2.793	2.907	90	120	100	130	220	330	260	370
2.90	2.842	2.958	90	120	100	130	220	330	260	370
2.95	2.891	3.009	90	120	100	130	220	330	260	370
3.00	2.940	3.060	80	100	90	110	220	300	260	350
3.05	2.989	3.111	80	100	90	110	220	300	260	350
3.10	3.038	3.162	80	100	90	110	200	280	240	330
3.15	3.087	3.213	80	100	90	110	200	280	240	330
3.20	3.136	3.264	80	100	90	110	200	280	240	330



Dropout Voltage – Table 2

SYMBOL	E-0		E-1				E-2			
PARAMETER OUTPUT VOLTAGE	Output Voltage (V)		Dropout Voltage 1 (mV) <i>(I_{OUT}=30mA)</i>				Dropout Voltage 2 (mV) <i>(I_{OUT}=100mA)</i>			
			<i>T_a=25°C</i>		<i>-40°C ≤ T_{opr} ≤ 85°C</i>		<i>T_a=25°C</i>		<i>-40°C ≤ T_{opr} ≤ 85°C</i>	
V_{OUT}(T)	V_{OUT}		V_{dif1}	V_{dif1}	V_{dif1}	V_{dif1}	V_{dif2}	V_{dif2}	V_{dif2}	V_{dif2}
	MIN	MAX	TYP	MAX	TYP	MAX	TYP	MAX	TYP	MAX
3.25	3.185	3.315	80	100	90	110	200	280	240	330
3.30	3.234	3.366	80	100	90	110	200	280	240	330
3.35	3.283	3.417	80	100	90	110	200	280	240	330
3.40	3.332	3.468	80	100	90	110	200	280	240	330
3.45	3.381	3.519	80	100	90	110	200	280	240	330
3.50	3.430	3.570	80	100	90	110	200	280	240	330
3.55	3.479	3.621	80	100	90	110	200	280	240	330
3.60	3.528	3.672	80	100	90	110	200	280	240	330
3.65	3.577	3.723	80	100	90	110	200	280	240	330
3.70	3.626	3.774	80	100	90	110	200	280	240	330
3.75	3.675	3.825	80	100	90	110	200	280	240	330
3.80	3.724	3.876	80	100	90	110	200	280	240	330
3.85	3.773	3.927	80	100	90	110	200	280	240	330
3.90	3.822	3.978	80	100	90	110	200	280	240	330
3.95	3.871	4.029	80	100	90	110	200	280	240	330
4.00	3.920	4.080	70	90	80	100	180	260	220	310
4.05	3.969	4.131	70	90	80	100	180	260	220	310
4.10	4.018	4.182	70	90	80	100	180	260	220	310
4.15	4.067	4.233	70	90	80	100	180	260	220	310
4.20	4.116	4.284	70	90	80	100	180	260	220	310
4.25	4.165	4.335	70	90	80	100	180	260	220	310
4.30	4.214	4.386	70	90	80	100	180	260	220	310
4.35	4.263	4.437	70	90	80	100	180	260	220	310
4.40	4.312	4.488	70	90	80	100	180	260	220	310
4.45	4.361	4.539	70	90	80	100	180	260	220	310
4.50	4.410	4.590	70	90	80	100	180	260	220	310
4.55	4.459	4.641	70	90	80	100	180	260	220	310
4.60	4.508	4.692	70	90	80	100	180	260	220	310
4.65	4.557	4.743	70	90	80	100	180	260	220	310



Dropout Voltage – Table 3

SYMBOL	E-0		E-1				E-2			
PARAMETER OUTPUT VOLTAGE	Output Voltage (V)		Dropout Voltage 1 (mV) <i>(I_{OUT}=30mA)</i>				Dropout Voltage 2 (mV) <i>(I_{OUT}=100mA)</i>			
			<i>T_a=25°C</i>		<i>-40°C ≤ T_{opr} ≤ 85°C</i>		<i>T_a=25°C</i>		<i>-40°C ≤ T_{opr} ≤ 85°C</i>	
V_{OUT}(T)	V_{OUT}		V_{dif1}	V_{dif1}	V_{dif1}	V_{dif1}	V_{dif2}	V_{dif2}	V_{dif2}	V_{dif2}
	MIN	MAX	TYP	MAX	TYP	MAX	TYP	MAX	TYP	MAX
4.70	4.606	4.794	70	90	80	100	180	260	220	310
4.75	4.655	4.845	70	90	80	100	180	260	220	310
4.80	4.704	4.896	70	90	80	100	180	260	220	310
4.85	4.753	4.947	70	90	80	100	180	260	220	310
4.90	4.802	4.998	70	90	80	100	180	260	220	310
4.95	4.851	5.049	70	90	80	100	180	260	220	310
5.00	4.900	5.100	50	80	60	90	160	240	200	290
5.05	4.949	5.151	50	80	60	90	160	240	200	290
5.10	4.998	5.202	50	80	60	90	160	240	200	290
5.15	5.047	5.253	50	80	60	90	160	240	200	290
5.20	5.096	5.304	50	80	60	90	160	240	200	290
5.25	5.145	5.355	50	80	60	90	160	240	200	290
5.30	5.194	5.406	50	80	60	90	160	240	200	290
5.35	5.243	5.457	50	80	60	90	160	240	200	290
5.40	5.292	5.508	50	80	60	90	160	240	200	290
5.45	5.341	5.559	50	80	60	90	160	240	200	290
5.50	5.390	5.610	50	80	60	90	160	240	200	290
5.55	5.439	5.661	50	80	60	90	160	240	200	290
5.60	5.488	5.712	50	80	60	90	160	240	200	290
5.65	5.537	5.763	50	80	60	90	160	240	200	290
5.70	5.586	5.814	50	80	60	90	160	240	200	290
5.75	5.635	5.865	50	80	60	90	160	240	200	290
5.80	5.684	5.916	50	80	60	90	160	240	200	290
5.85	5.733	5.967	50	80	60	90	160	240	200	290
5.90	5.782	6.018	50	80	60	90	160	240	200	290
5.95	5.831	6.069	50	80	60	90	160	240	200	290
6.00	5.880	6.120	50	80	60	90	160	240	200	290



■ Typical Performance Characteristics

(1) Output Voltage VS Output Current

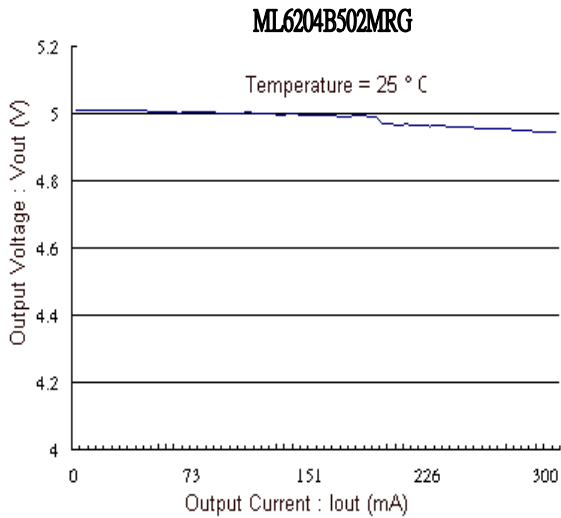
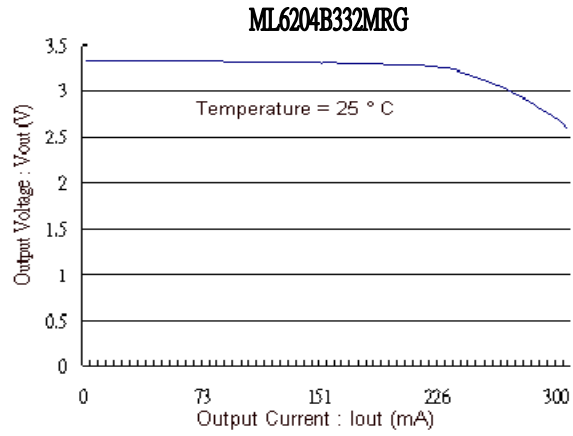
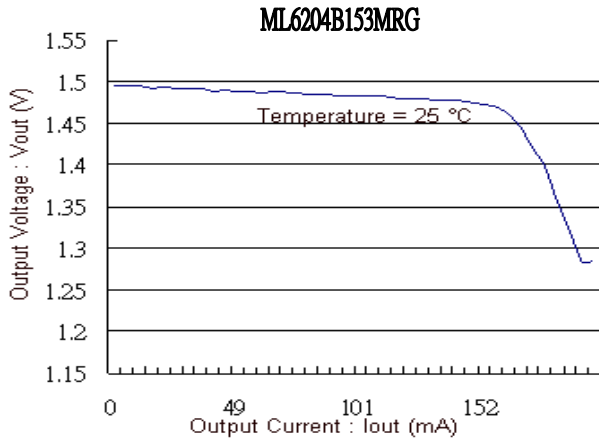

(2) Output Voltage VS Input Voltage

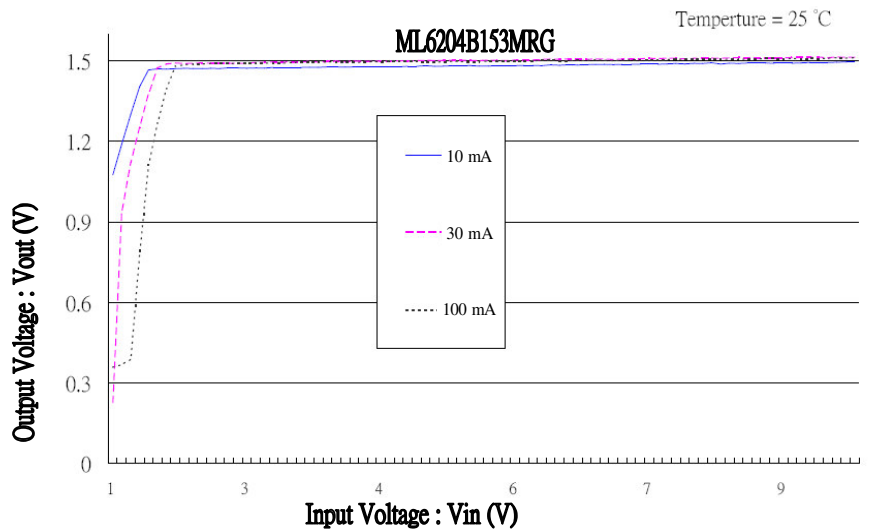

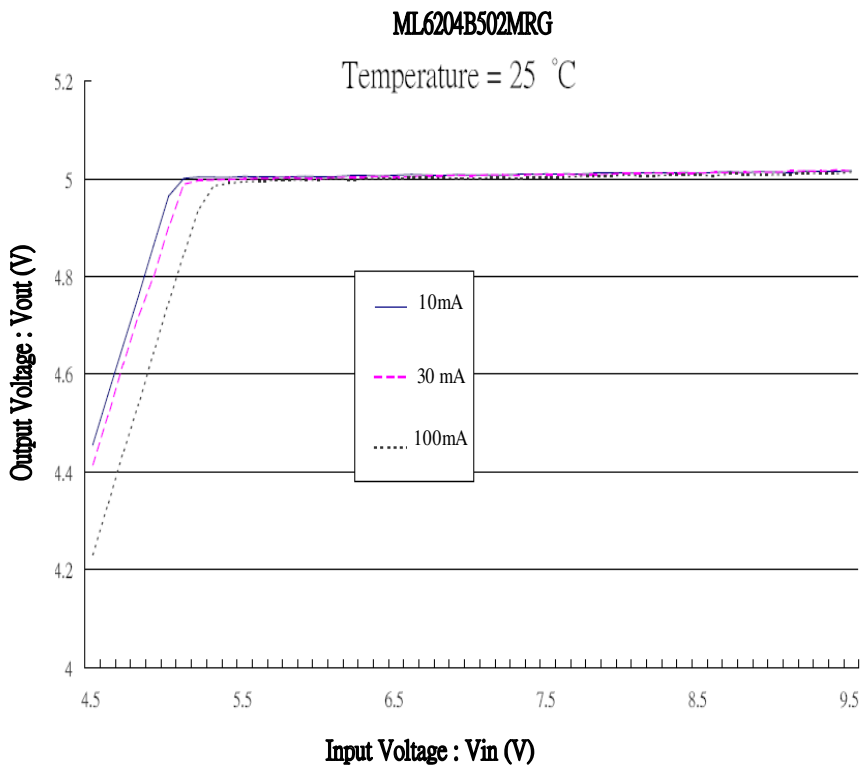
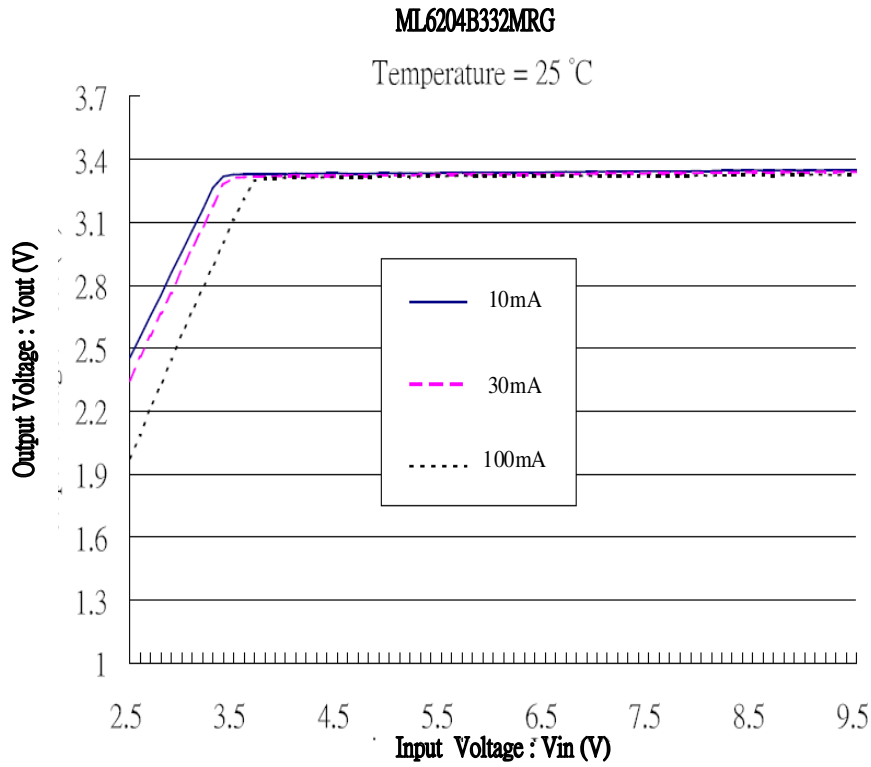

(3) Supply Current VS Input Voltage

ML6204B153MRG

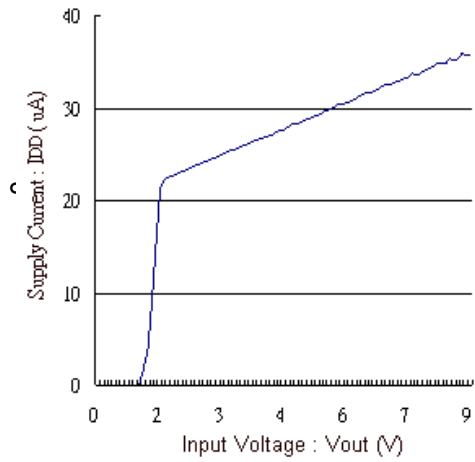

ML6204B332MRG

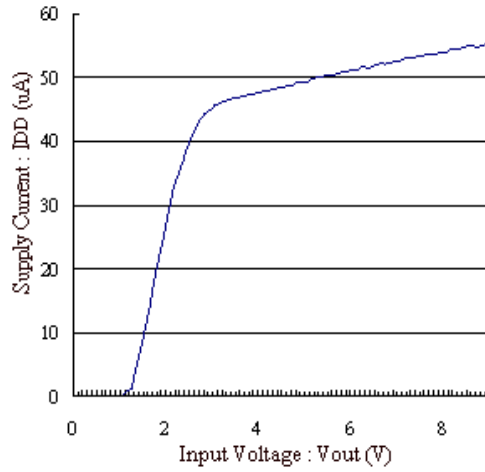

ML6204B502MRG

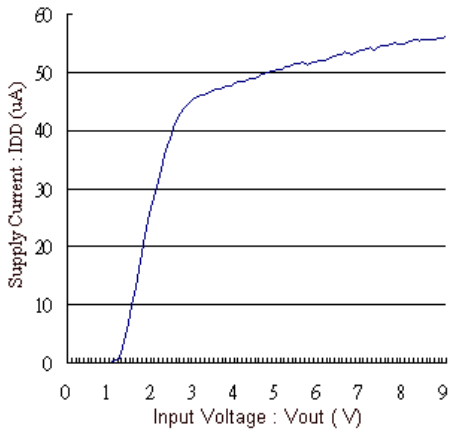

(4) Input Transient Responses

ML6204B153MRG

$V_{in} = 2.5V$ to $3.5V$, $t_r = t_f = 20 \mu\text{sec}$
 $C_{in} = C_L = 1\mu\text{F}$ (Ceramic)

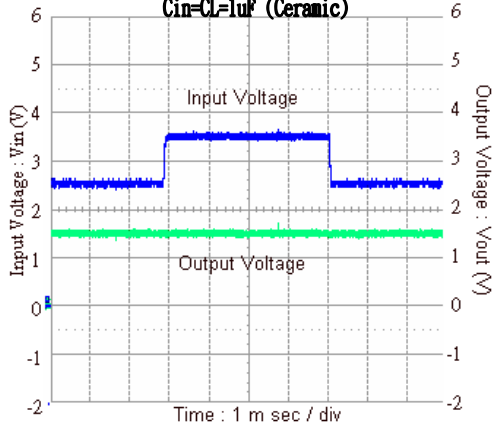

ML6204B153MRG

$V_{in} = 2.5V$ to $3.5V$, $t_r = t_f = 20 \mu\text{sec}$
 $C_{in} = C_L = 1\mu\text{F}$ (Ceramic)

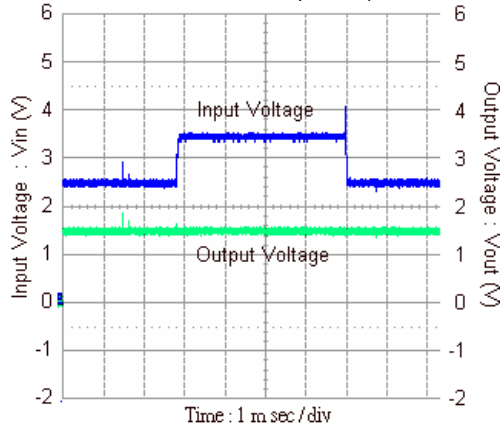

ML6204B332MRG

$V_{in} = 4.3V$ to $5.3V$, $t_r = t_f = 20 \mu\text{sec}$
 $C_{in} = C_L = 1\mu\text{F}$ (Ceramic)

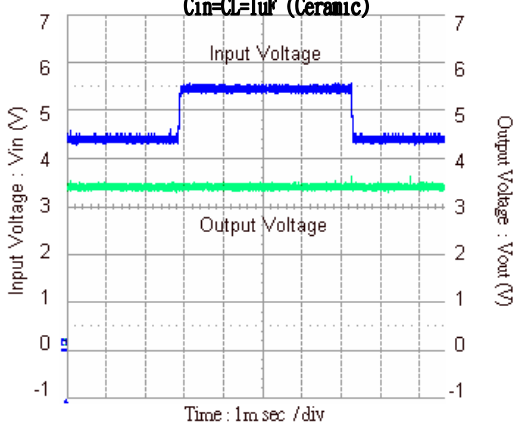

ML6204B332MRG

$V_{in} = 4.3V$ to $5.3V$, $t_r = t_f = 20 \mu\text{sec}$
 $C_{in} = C_L = 1\mu\text{F}$ (Ceramic)

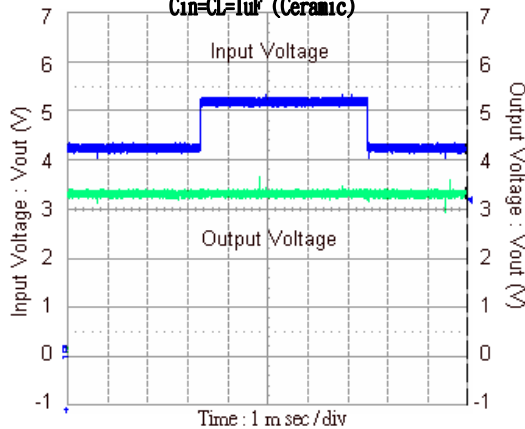

ML6204B502MRG

$V_{in} = 6V$ to $7V$, $t_r = t_f = 20 \mu\text{sec}$
 $C_{in} = C_L = 1\mu\text{F}$ (Ceramic)

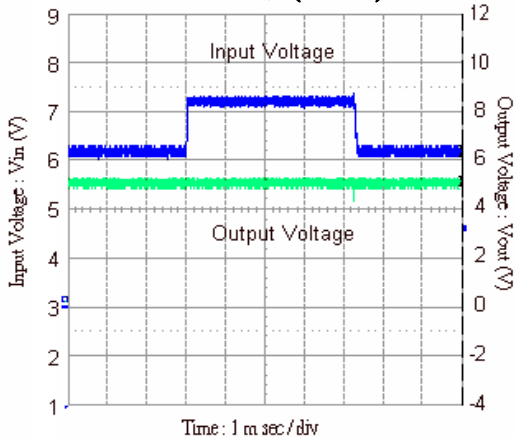

ML6204B502MRG

$V_{in} = 6V$ to $7V$, $t_r = t_f = 20 \mu\text{sec}$
 $C_{in} = C_L = 1\mu\text{F}$ (Ceramic)

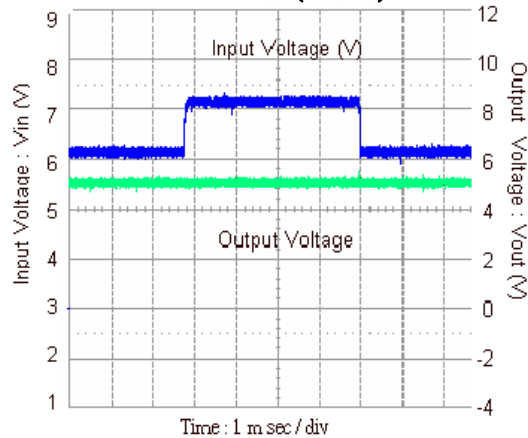

(5) Load Transient Response (1)

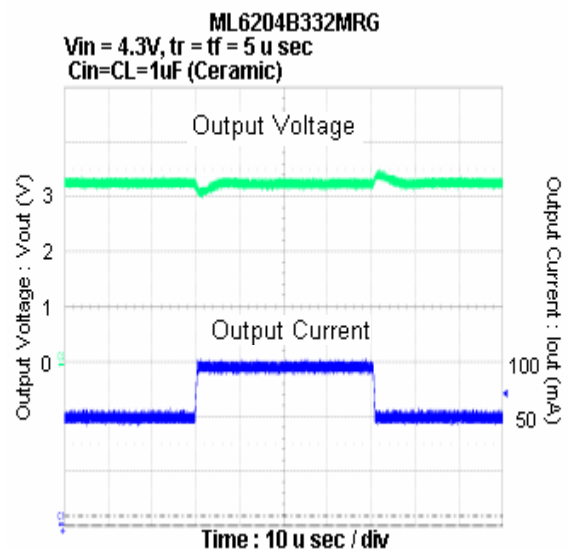
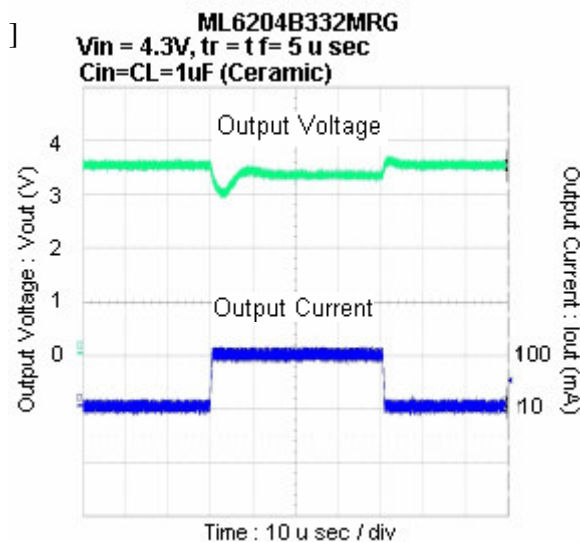
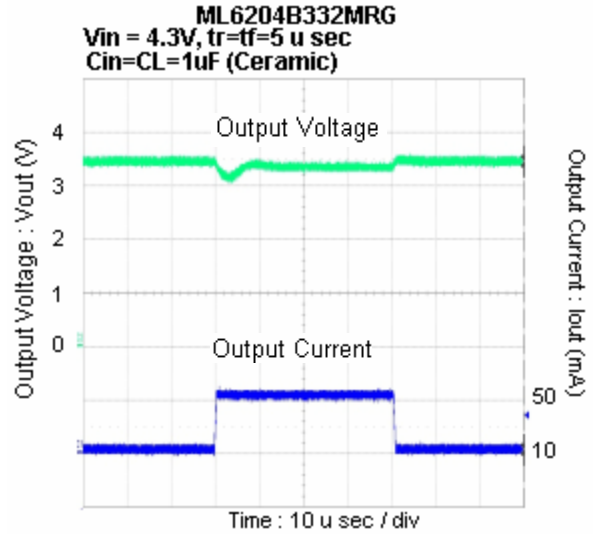
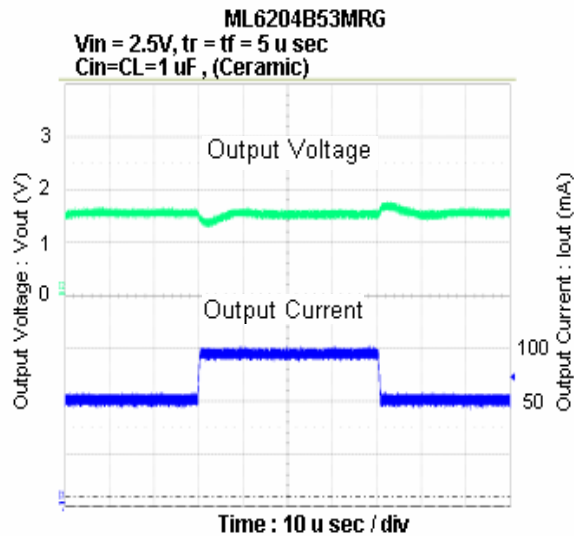
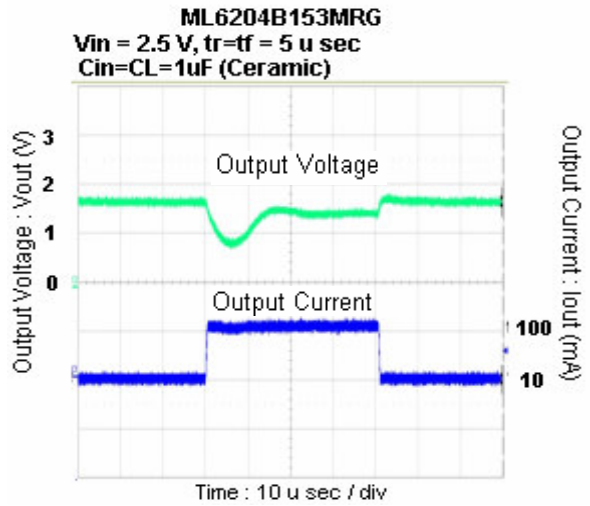
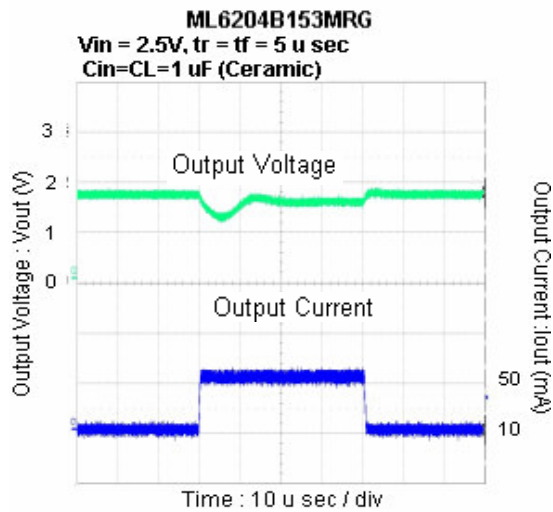

(5) Load Transient Response (2)

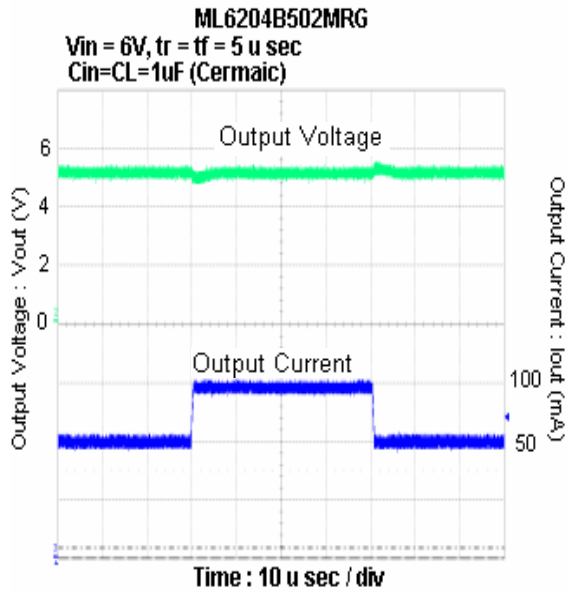
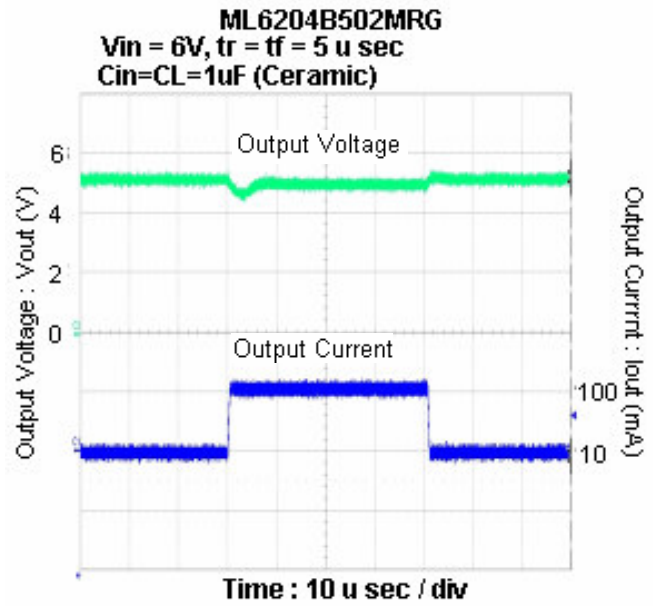
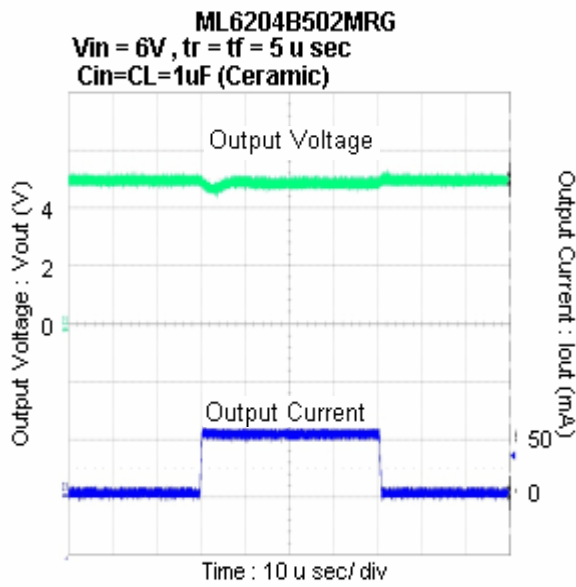



(6) Turn on Response Time

ML6204B153MRG

$V_{in} = 0$ to $2.5V$, $I_{out} = 30mA$, $t_r = t_f = 50 \mu sec$
 $C_{in} = C_L = 1\mu F$

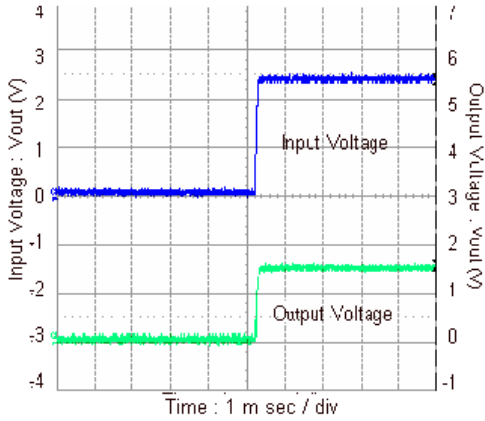

ML6204B153MRG

$V_{in} = 0$ to $2.5V$, $I_{out} = 100mA$, $t_r = t_f = 50 \mu sec$
 $C_{in} = C_L = 1\mu F$

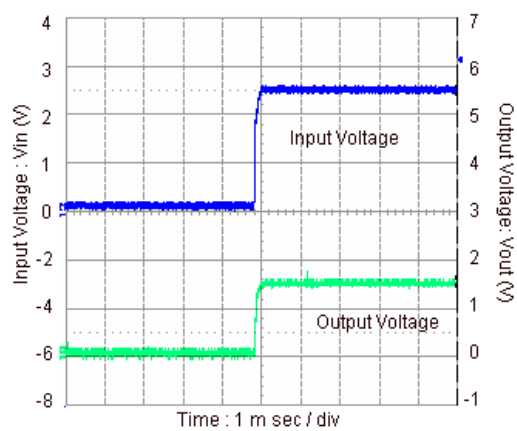

ML6204B332MRG

$V_{in} = 0$ to $4.3V$, $I_{out} = 30mA$, $t_r = t_f = 50 \mu sec$
 $C_{in} = C_L = 1\mu F$

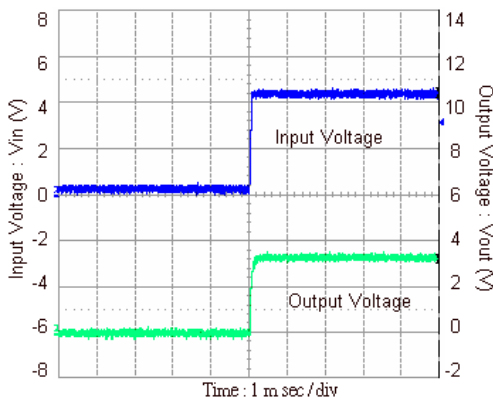

ML6204B332MRG

$V_{in} = 0$ to $4.3V$, $I_{out} = 30mA$, $t_r = t_f = 50 \mu sec$
 $C_{in} = C_L = 1\mu F$

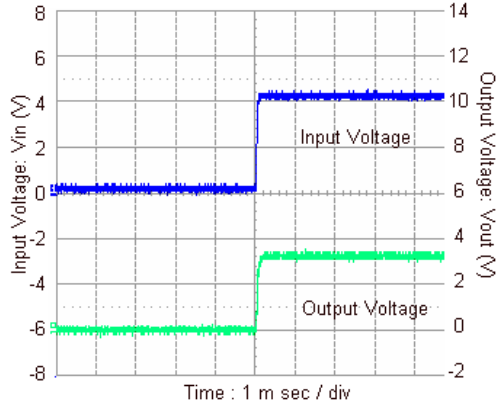

ML6204B502MRG

$V_{in} = 0$ to $6V$, $I_{out} = 30mA$, $t_r = t_f = 50 \mu sec$
 $C_{in} = C_L = 1\mu F$

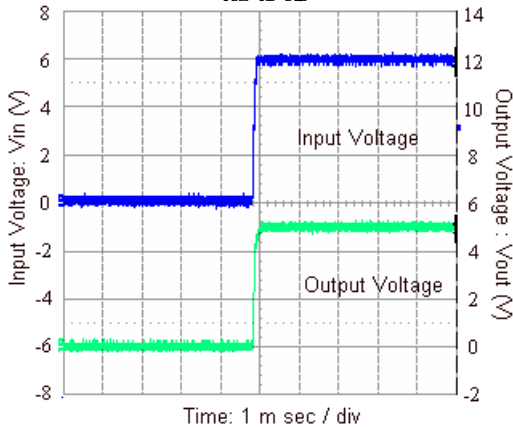

ML6204B502MRG

$V_{in} = 0$ to $6V$, $I_{out} = 30mA$, $t_r = t_f = 50 \mu sec$
 $C_{in} = C_L = 1\mu F$

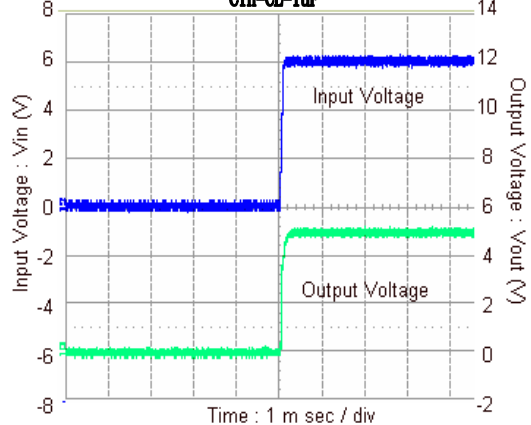

(7) Enable Response Time

ML6204B153MRG

$V_{in} = 2.5V$, $I_{out} = 30mA$, $t_r = t_f = 5 \mu sec$
 $V_{CE} = 0$ to $2.5V$, $C_{in} = C_L = 1\mu F$

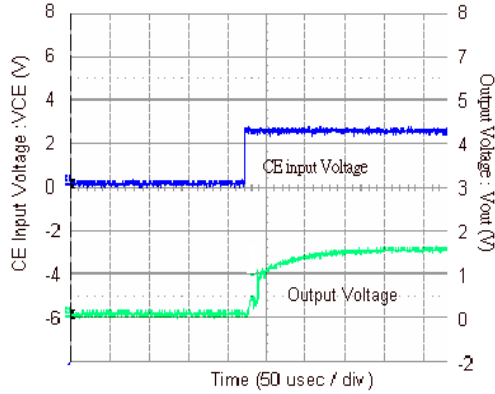

ML6204B153MRG

$V_{in} = 2.5V$, $I_{out} = 100mA$, $t_r = t_f = 5 \mu sec$
 $V_{CE} = 0$ to $2.5V$, $C_{in} = C_L = 1\mu F$

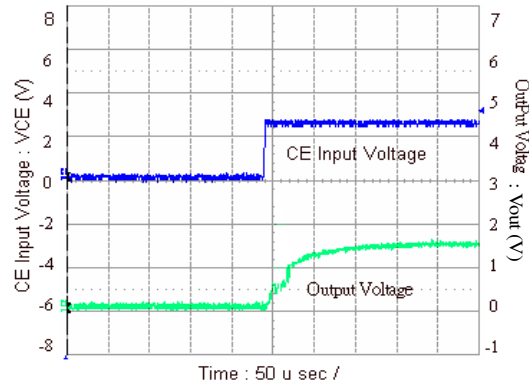

ML6204B332MRG

$V_{in} = 4.3V$, $I_{out} = 30mA$, $t_r = t_f = 5 \mu sec$
 $V_{CE} = 0$ to $4.3V$, $C_{in} = C_L = 1\mu F$

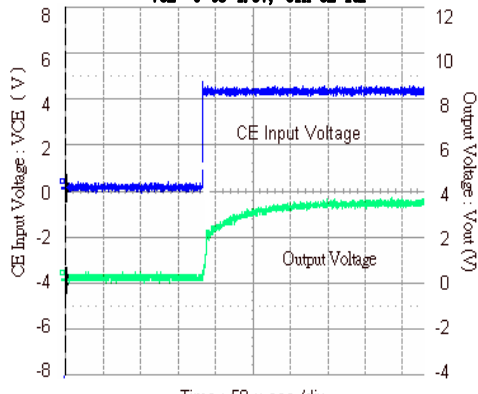

ML6204B332MRG

$V_{in} = 4.3V$, $I_{out} = 100mA$, $t_r = t_f = 5 \mu sec$
 $V_{CE} = 0$ to $4.3V$, $C_{in} = C_L = 1\mu F$

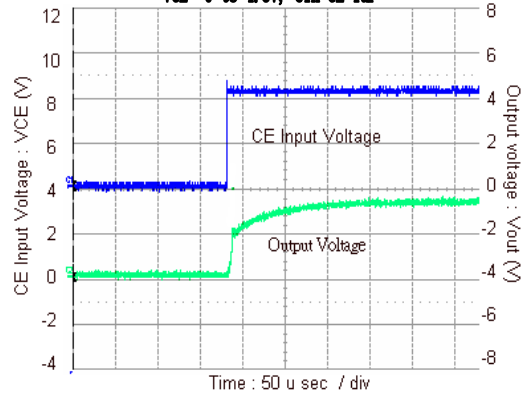

ML6204B502MRG

$V_{in} = 6V$, $I_{out} = 30mA$, $t_r = t_f = 5 \mu sec$
 $V_{CE} = 0$ to $6V$, $C_{in} = C_L = 1\mu F$

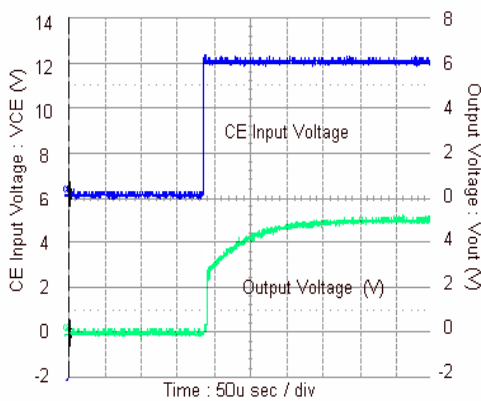

ML6204B502MRG

$V_{in} = 6V$, $I_{out} = 100mA$, $t_r = t_f = 5 \mu sec$
 $V_{CE} = 0$ to $6V$, $C_{in} = C_L = 1\mu F$

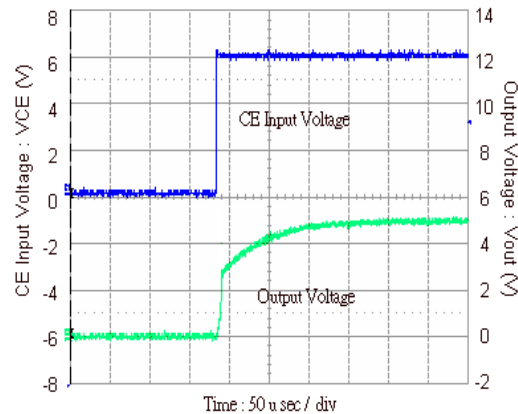

DISCLAIMER:

The information presented in this document does not form part of any quotation or contract, is believed to be accurate and reliable and may be changed without notice. No liability will be accepted by the publisher for any consequence of its use.