

Ultra-Small, Low-Power, Window Comparator in 4 UCSP and 5 SOT23

General Description

The MAX9065 is an ultra-small, low-power, window comparator ideal for a wide variety of portable electronics applications such as cell phones, portable media players, and notebooks that have extremely tight board space and power constraints. It comes in both a 4-bump UCSP™ package with a 1mm x 1mm footprint (as small as two 0402 resistors) and a 5-pin SOT23 package.

The MAX9065 features a common-mode input range of -0.3V to +5.5V independent of supply voltage. The input current goes to zero when the MAX9065 is powered down ($V_{CC} = 0$). Additionally, the MAX9065 features high RF immunity.

The MAX9065 has a push-pull output and consumes only 1 μ A (max) supply current. The MAX9065 operates down to 1.0V over the extended -40°C to +85°C temperature range.

Applications

Cell Phones
Portable Media Players
Electronic Toys
Notebook Computers
Portable Medical Devices

Pin Configurations

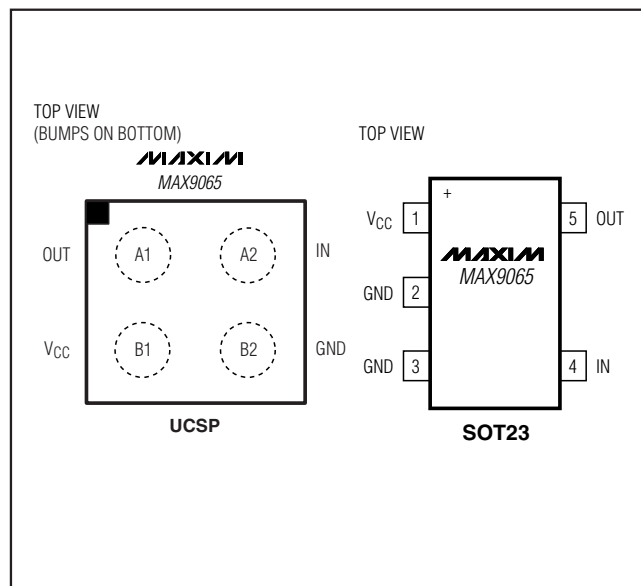

UCSP is a trademark of Maxim Integrated Products, Inc.

Features

- ◆ Tiny 1mm x 1mm 4-Bump UCSP
Footprint = Two 0402 Resistors
Also Available in 5-Pin SOT23 Package
- ◆ Ultra-Low Power Operating Current
1 μ A (max)
- ◆ -0.3V to +5.5V Input Voltage Range
- ◆ 1.0V to 5.5V V_{CC} Range
- ◆ 3.0V and 4.2V Trigger Points
- ◆ -40°C to +85°C Extended Temperature Range

Ordering Information

PART	PIN-PACKAGE	TOP MARK
MAX9065EBS+	4 UCSP	AGC
MAX9065EUK+	5 SOT23	AFFL

Note: All devices are specified over the extended -40°C to +85°C operating temperature range.

+Denotes a lead-free/RoHS-compliant package.

Typical Operating Circuit

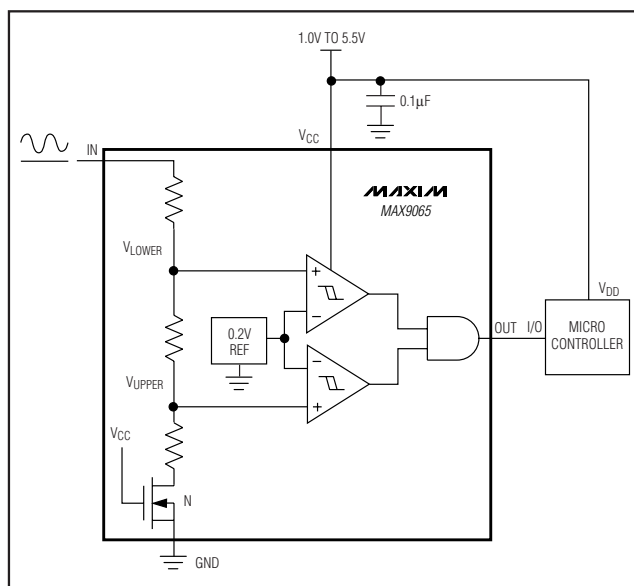

Ultra-Small, Low-Power, Window Comparator in 4 UCSP and 5 SOT23

ABSOLUTE MAXIMUM RATINGS

V_{CC}, I_N to GND-0.3V to +6V
 OUT to GND-0.3V to (V_{CC} + 0.3V)
 Output Short-Circuit Current Duration10s
 Input Current into Any Terminal±20mA
 Continuous Power Dissipation
 4-Bump UCSP (derate 3.0mW/°C above +70°C).....238mW
 5-Pin SOT23 (derate 3.9mW/°C above +70°C).....312mW

Operating Temperature Range-40°C to +85°C
 Junction Temperature+150°C
 Storage Temperature Range-65°C to +150°C
 Bump Temperature (soldering) Reflow+235°C
 Lead Temperature (soldering, 10s)+300°C

Stresses beyond those listed under "Absolute Maximum Ratings" may cause permanent damage to the device. These are stress ratings only, and functional operation of the device at these or any other conditions beyond those indicated in the operational sections of the specifications is not implied. Exposure to absolute maximum rating conditions for extended periods may affect device reliability.

ELECTRICAL CHARACTERISTICS

(V_{CC} = 3.3V, T_A = -40°C to +85°C. Typical values are at T_A = +25°C, unless otherwise noted.) (Note 1)

PARAMETER	SYMBOL	CONDITIONS	MIN	TYP	MAX	UNITS	
DC CHARACTERISTICS							
Upper Threshold Voltage	UTV	MAX9065EBS+ 4 UCSP	T _A = +25°C	4.158	4.20	4.242	V
			-40°C < T _A < +85°C	4.10		4.30	
		MAX9065EUK+ 5 SOT23	T _A = +25°C	4.04	4.20	4.36	
			-40°C < T _A < +85°C	3.98		4.42	
Lower Threshold Voltage	LTV	MAX9065EBS+ 4 UCSP	T _A = +25°C	2.94	3.00	3.06	V
			-40°C < T _A < +85°C	2.92		3.08	
		MAX9065EUK+ 5 SOT23	T _A = +25°C	2.88	3.00	3.12	
			-40°C < T _A < +85°C	2.83		3.17	
Input Voltage Range	V _{IN}		-0.3		+5.5	V	
Hysteresis	V _{HYS}	(Note 2)		±1.0		%	
Resistor String Input Resistance	R _{IN}		5.8	11	17.7	MΩ	
Input Shutdown Current	I _{IN_SHDN}	V _{CC} = 0, V _{IN} = 5.5V		1	15	nA	
Output Voltage Low	VOL	I _{SINK} = 100μA, V _{CC} = 1V, T _A = +25°C			0.2	V	
		I _{SINK} = 1.2mA, V _{CC} = 3.3V			0.3		
		I _{SINK} = 1.2mA, V _{CC} = 5.5V			0.5		
Output Voltage High	VOH	I _{SOURCE} = 25μA, V _{CC} = 1V, T _A = +25°C			V _{CC} - 0.2	V	
		I _{SOURCE} = 0.3mA, V _{CC} = 3.3V			V _{CC} - 0.3		
		I _{SOURCE} = 0.75mA, V _{CC} = 5.5V			V _{CC} - 0.5		
AC CHARACTERISTICS							
Propagation Delay	t _{PD}	Overdrive = ±100mV (Notes 3, 4)		25		μs	
Fall Time	t _F	C _L = 10pF		14		ns	
Rise Time	t _R	C _L = 10pF		30		ns	
POWER SUPPLY							
Supply Voltage	V _{CC}	Guaranteed by V _{OS} tests	1		5.5	V	

Ultra-Small, Low-Power, Window Comparator in 4 UCSP and 5 SOT23

MAX9065

ELECTRICAL CHARACTERISTICS (continued)

($V_{CC} = 3.3V$, $T_A = -40^{\circ}C$ to $+85^{\circ}C$. Typical values are at $T_A = +25^{\circ}C$, unless otherwise noted.) (Note 1)

PARAMETER	SYMBOL	CONDITIONS	MIN	TYP	MAX	UNITS
Supply Current	I_{CC}	$V_{CC} = 5.5V$		0.7	1.35	μA
		$V_{CC} = 1.0V$, $T_A = +25^{\circ}C$		0.6	1.0	
Power-Supply Rejection Ratio	PSRR	$V_{CC} = 0.9V$ to $5.5V$, $T_A = +25^{\circ}C$	40	53		dB
Power-Up Time	t_{ON}			3		ms

Note 1: All devices are 100% production tested at $T_A = +25^{\circ}C$. Temperature limits are guaranteed by design.

Note 2: Hysteresis is the input voltage difference between the two switching points.

Note 3: Overdrive is defined as the voltage above or below the average of the switching points.

Note 4: Guaranteed by ATE and/or bench characterization over temperature.

Typical Operating Characteristics

($V_{CC} = 3.3V$, $T_A = -40^{\circ}C$ to $+85^{\circ}C$. Typical values are at $T_A = +25^{\circ}C$, unless otherwise noted.)

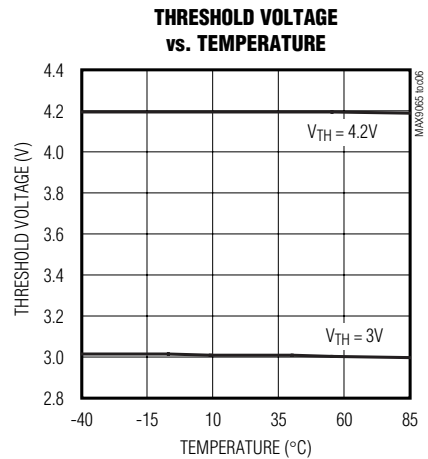
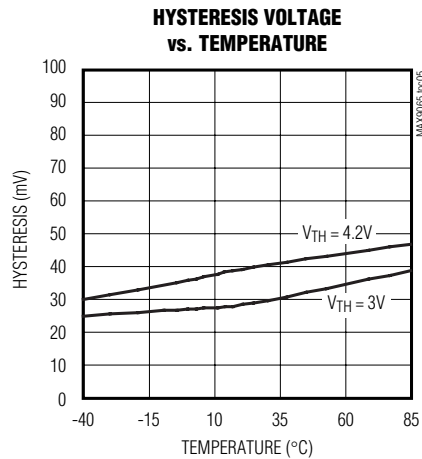
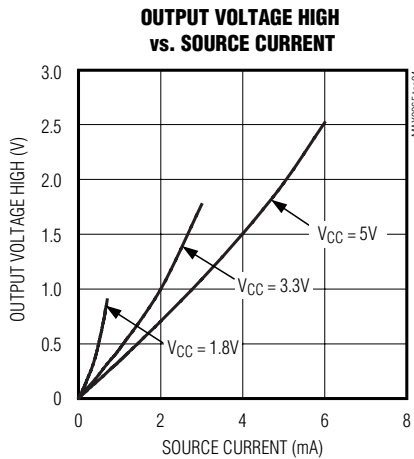
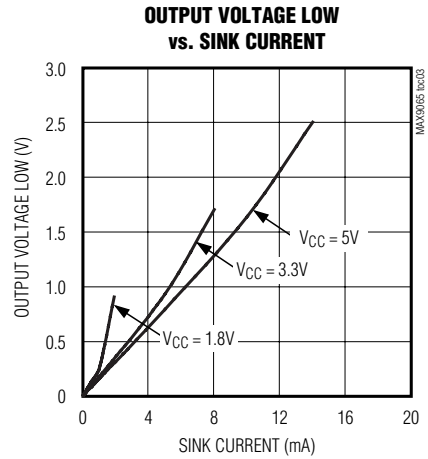
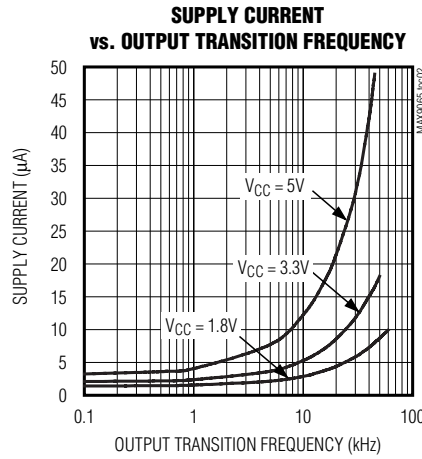
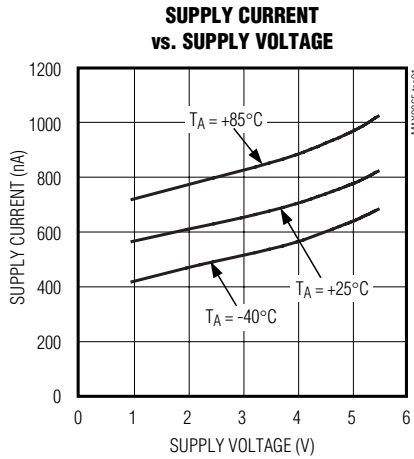

Ultra-Small, Low-Power, Window Comparator in 4 UCSP and 5 SOT23

Typical Operating Characteristics (continued)

($V_{CC} = 3.3V$, $T_A = -40^{\circ}C$ to $+85^{\circ}C$. Typical values are at $T_A = +25^{\circ}C$, unless otherwise noted.)

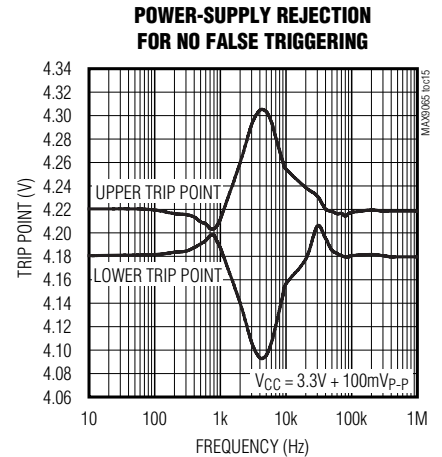
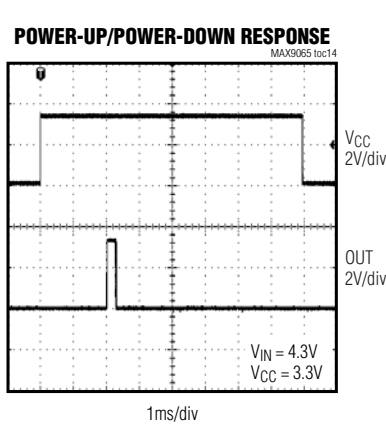
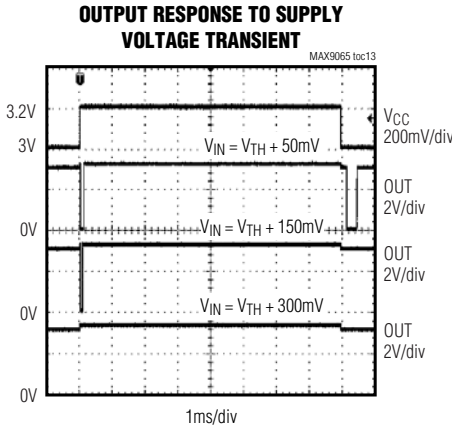
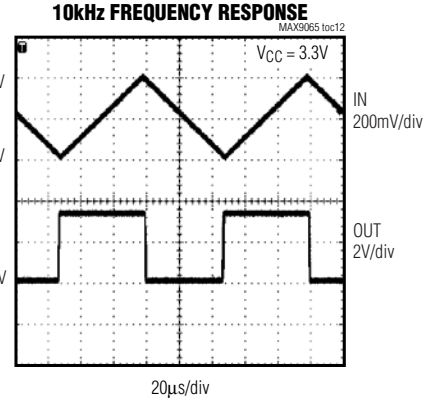
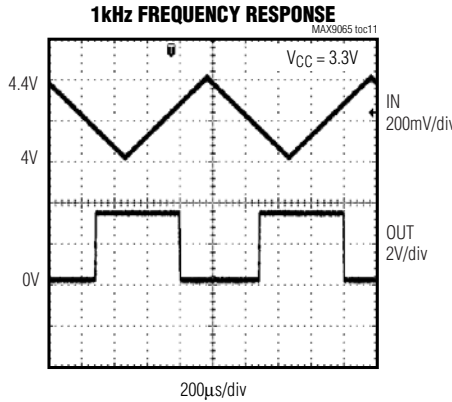
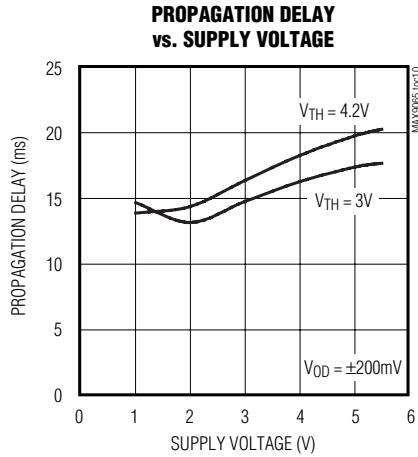
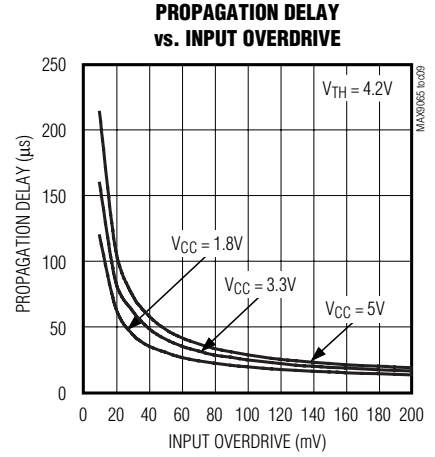
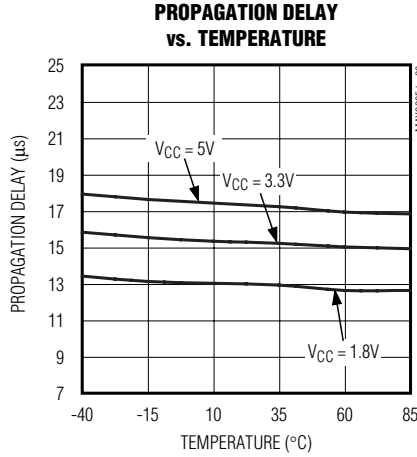
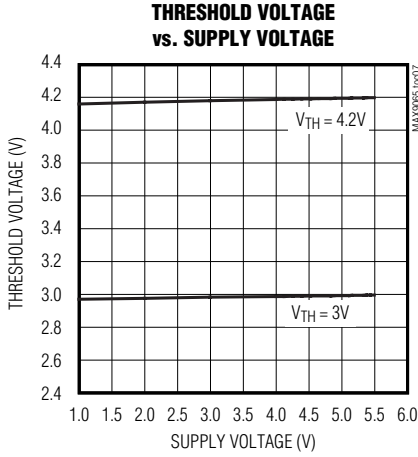

Ultra-Small, Low-Power, Window Comparator in 4 UCSP and 5 SOT23

MAX9065

Pin Description

PIN		NAME	FUNCTION
SOT23	UCSP		
1	B1	VCC	External Supply Input. Bypass to ground with a 0.1μF bypass capacitor.
2, 3	B2	GND	Ground
4	A2	IN	Window Comparator Input
5	A1	OUT	Push-Pull Output

Detailed Description

The MAX9065 is an extremely small window comparator designed for compact, low-current applications, featuring a supply current of less than 1μA (max).

Operation

At the heart of the MAX9065 are two comparators, a resistor-divider with a disconnect switch, a 200mV reference, digital logic circuitry, and an output stage (see the *Typical Operating Circuit*).

The digital logic circuitry and the output stage together behave like an AND gate. The gate's inputs are the outputs of the two comparators. When either comparator's output is low, the output asserts low. When both comparator's outputs are high, the output asserts high.

When power is applied to VCC, the n-channel FET at the bottom of the resistor-divider is turned on. The resistor-divider provides two voltages, V_{UPPER} and V_{LOWER}, for comparison with an internal 0.2V reference voltage. When the input voltage exceeds 4.2V, V_{UPPER} is greater than 0.2V, causing the output to assert low. When the input voltage falls below 3.0V, V_{LOWER} is less

Table 1. MAX9065 Operation

INPUT VOLTAGE	OUTPUT
V _{IN} > 4.2V	Low
3.0V < V _{IN} < 4.2V	High
V _{IN} < 3.0V	Low

than 0.2V, causing the output also to assert low. With the input voltage between 3.0V and 4.2V, the output asserts high, indicating that the input voltage is within the desired range. Table 1 summarizes the operation of the MAX9065.

When VCC goes to 0V, the n-channel FET is turned off, eliminating the resistor-divider as a leakage path for current.

Applications

The MAX9065 is designed specifically to monitor the voltage on a single lithium battery. Keeping the voltage on a lithium battery within a tight range is important to prevent damage to the battery. Specifically, ensuring that the battery's voltage neither exceeds 4.2V nor falls below 3.0V lengthens the lifetime of the battery and avoids any hazardous battery conditions.

Hysteresis

There are four trip points for hysteresis. See Figure 1.

Power-Supply Considerations

Bypass VCC with a 0.1μF capacitor to ground.

Chip Information

PROCESS: BiCMOS

Ultra-Small, Low-Power, Window Comparator in 4 UCSP and 5 SOT23

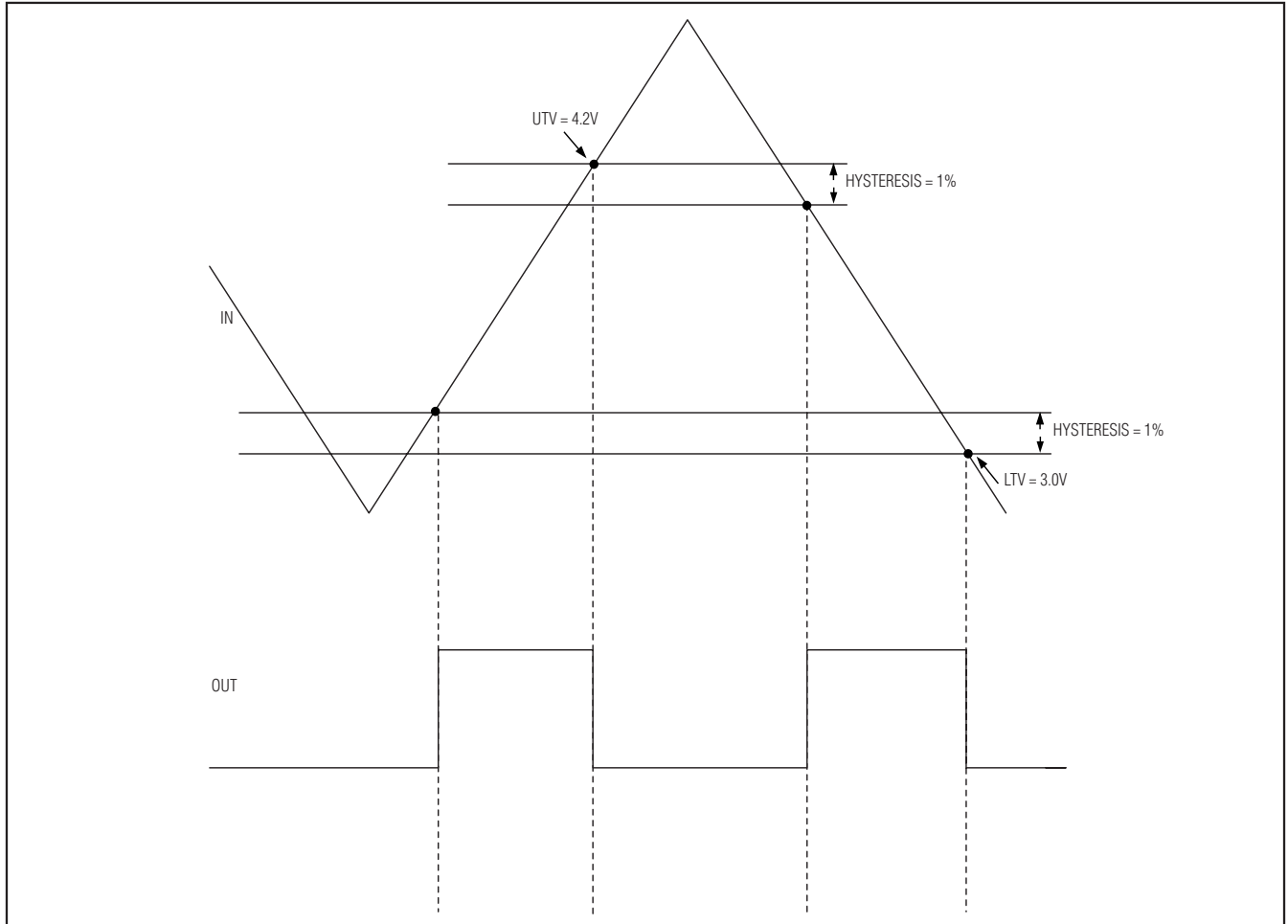

Figure 1. Hysteresis Trip Points

Ultra-Small, Low-Power, Window Comparator in 4 UCSP and 5 SOT23

MAX9065

Package Information

For the latest package outline information and land patterns, go to www.maxim-ic.com/packages.

PACKAGE TYPE	PACKAGE CODE	DOCUMENT NO.
4 UCSP	B4-1	21-0117
5 SOT23	U5-2	21-0057

TOP VIEW

COMMON DIMENSIONS	
A	0.62±0.05-0.08
A1	0.29±0.02
A2	0.33 REF.
b	∅0.35±0.03
D1	0.50 BASIC
E1	0.50 BASIC
e	0.50 BASIC
SD	0.25 BASIC
SE	0.25 BASIC

PKG. CODE	VARIABLE DIMENSIONS		DEPOPULATED SOLDER BALLS
	D	E	
B4-1	1.00±0.05	1.00±0.05	NONE
B4-2	1.05±0.05	1.05±0.05	NONE
B4-3	1.10±0.05	1.10±0.05	NONE
B4-4	0.97±0.05	0.97±0.05	NONE

NOTES:

- ALL DIMENSIONS ARE IN MILLIMETERS.
- PRODUCT MARKING: NUMBER OF CHARACTERS AND LINES VARY PER PRODUCT.

BOTTOM VIEW

SIDE VIEW

4L UCSP 2x2.EPS

DALLAS SEMICONDUCTOR		
MAXIM		
PROPRIETARY INFORMATION		
TITLE: PACKAGE OUTLINE, 2x2 UCSP		
APPROVAL	DOCUMENT CONTROL NO. 21-0117	REV. G 1/1

Ultra-Small, Low-Power, Window Comparator in 4 UCSP and 5 SOT23

Package Information (continued)

For the latest package outline information and land patterns, go to www.maxim-ic.com/packages.

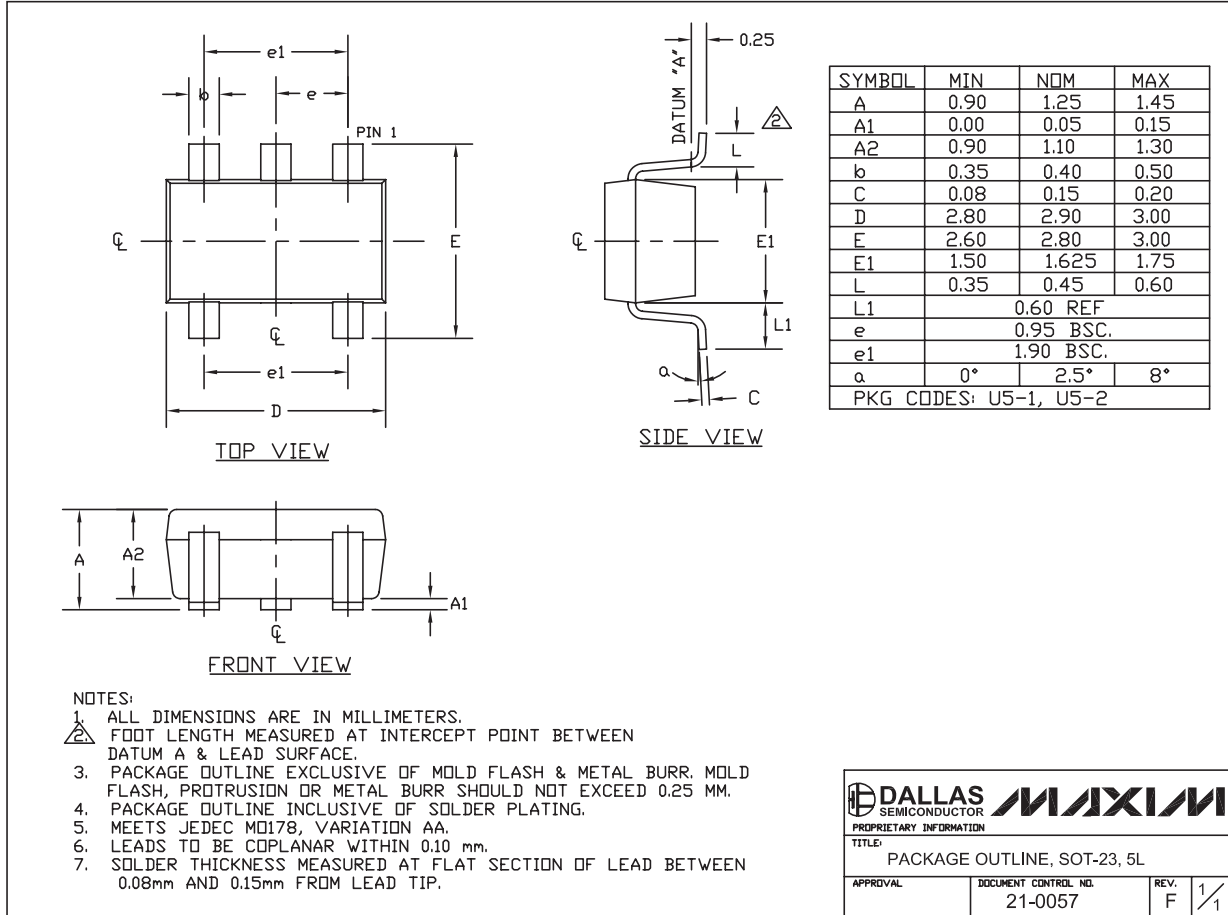

SOT-23 5L.EPS

Ultra-Small, Low-Power, Window Comparator in 4 UCSP and 5 SOT23

Revision History

REVISION NUMBER	REVISION DATE	DESCRIPTION	PAGES CHANGED
0	7/08	Initial release	—
1	10/08	Removed future part reference from 5 SOT23 package	1

MAX9065

Maxim cannot assume responsibility for use of any circuitry other than circuitry entirely embodied in a Maxim product. No circuit patent licenses are implied. Maxim reserves the right to change the circuitry and specifications without notice at any time.

Maxim Integrated Products, 120 San Gabriel Drive, Sunnyvale, CA 94086 408-737-7600 _____ **9**