

To all our customers

Regarding the change of names mentioned in the document, such as Mitsubishi Electric and Mitsubishi XX, to Renesas Technology Corp.

The semiconductor operations of Hitachi and Mitsubishi Electric were transferred to Renesas Technology Corporation on April 1st 2003. These operations include microcomputer, logic, analog and discrete devices, and memory chips other than DRAMs (flash memory, SRAMs etc.) Accordingly, although Mitsubishi Electric, Mitsubishi Electric Corporation, Mitsubishi Semiconductors, and other Mitsubishi brand names are mentioned in the document, these names have in fact all been changed to Renesas Technology Corp. Thank you for your understanding. Except for our corporate trademark, logo and corporate statement, no changes whatsoever have been made to the contents of the document, and these changes do not constitute any alteration to the contents of the document itself.

Note : Mitsubishi Electric will continue the business operations of high frequency & optical devices and power devices.

Renesas Technology Corp.
Customer Support Dept.
April 1, 2003

MITSUBISHI <LINEAR ICs>
M51924P,FP

QUAD COMPARATOR

DESCRIPTION

The M51924 is a quad (four independent) comparator and operates over a wide voltage range from a single supply voltage. Especially the M51924 has superiority as to characteristics of input current (input resistance) and fits to wide ranged applications, for example CR timer, oscillator, etc.

FEATURES

- Low input current 25nA (typ.)
- Wide supply voltage range 2.5~28V
- Low dissipation current
 0.8mA (typ.) (All output OFF)
 3mA (typ.) (ALL output ON)
- Enable high output drive $V_{OL}=0.15V$ (typ.)
 (Output current 20mA)

APPLICATION

Voltage comparator, window comparator, CR timer, time delay circuit, oscillator.

RECOMMENDED OPERATING CONDITIONS

- Supply voltage range 2.5~28V
- Rated supply voltage 12V

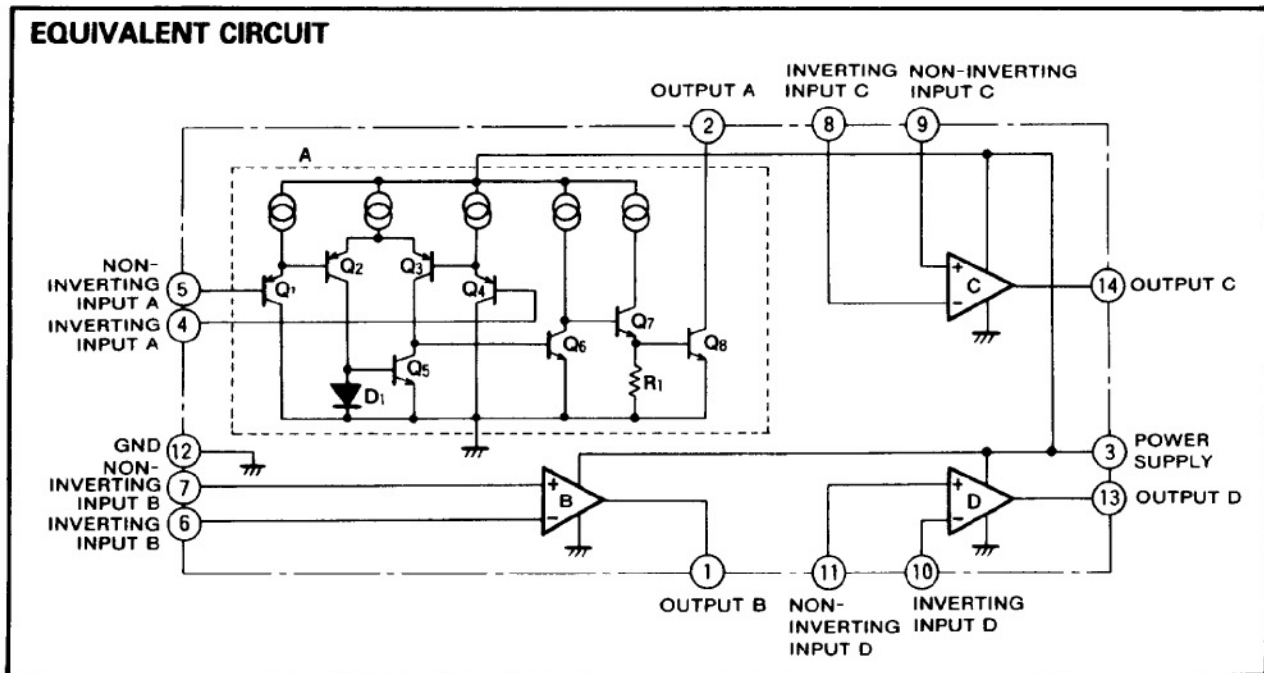
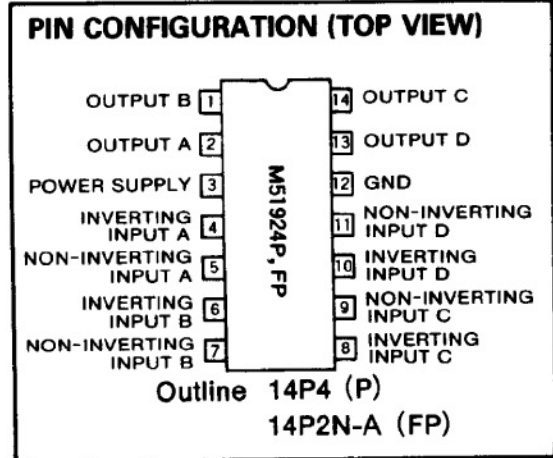

QUAD COMPARATOR

ABSOLUTE MAXIMUM RATINGS ($T_a=25^{\circ}\text{C}$, unless otherwise noted)

| Symbol | Parameter | Conditions | Ratings | Unit |
|------------|---------------------------------|------------|--------------------|--------------------|
| V_{CC} | Supply voltage | | 28 | V |
| V_{ID} | Differential input voltage | | V_{CC} | V |
| V_{ICM} | Common mode input voltage range | | $-0.3 \sim V_{CC}$ | V |
| I_{sink} | Output sink current | | 80 | mA |
| V_{OH} | "H" output voltage | | 30 | V |
| P_d | Power dissipation | | 900(DIP)/350(FP) | mW |
| T_{opr} | Operating temperature | | $-20 \sim +75$ | $^{\circ}\text{C}$ |
| T_{stg} | Storage temperature | | $-40 \sim +125$ | $^{\circ}\text{C}$ |

ELECTRICAL CHARACTERISTICS ($T_a=25^{\circ}\text{C}$, $V_{CC}=2.5 \sim 28\text{V}$, unless otherwise noted)

| Symbol | Parameter | Test conditions | Limits | | | Unit |
|----------------|-------------------------------------|------------------------|--------|------|--------------|---------------|
| | | | Min | Typ | Max | |
| V_{CC} | Supply voltage range | | 2.5 | | 28 | V |
| I_{CC1} | Circuit current 1 | ALL OUTPUT ON | | 3.0 | 5.0 | mA |
| I_{CC2} | Circuit current 2 | ALL OUTPUT OFF | | 0.8 | 1.6 | mA |
| $V_{i\ominus}$ | Inverting input voltage range | NOTE | 0 | | $V_{CC}-1.5$ | V |
| $V_{i\oplus}$ | Non-inverting input voltage range | NOTE | 0 | | $V_{CC}-1.5$ | V |
| V_{IO} | Input offset voltage | | | 2 | 5 | mV |
| $I_{i\ominus}$ | Inverting input current | | | 25 | 150 | nA |
| $I_{i\oplus}$ | Non-inverting input current | | | 25 | 150 | nA |
| I_{IO} | Input offset current | | | 5 | 50 | nA |
| V_{OL} | "L" output voltage | $I_{sink}=20\text{mA}$ | | 0.15 | 0.4 | V |
| | | $I_{sink}=80\text{mA}$ | | 1 | | |
| I_{LO} | Output leak current | | | | 0.1 | μA |
| t_{PLH} | Output "L→H" propagation delay time | | | 2 | | μs |
| t_{PHL} | Output "H→L" propagation delay time | | | 0.2 | | μs |

NOTE) Either inverting or non-inverting inputs (reference side) should be within this range. (Abnormal operation will not occur when the other is within the range of 0 to V_{CC} .)

TYPICAL CHARACTERISTICS ($T_a=25^{\circ}\text{C}$, unless otherwise noted)

THERMAL DERATING (MAXIMUM RATING)

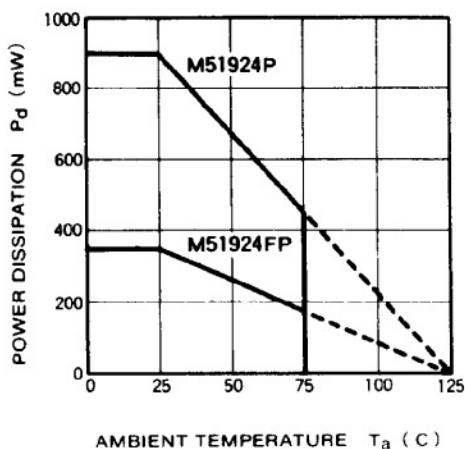

OUTPUT VOLTAGE VS. INPUT VOLTAGE

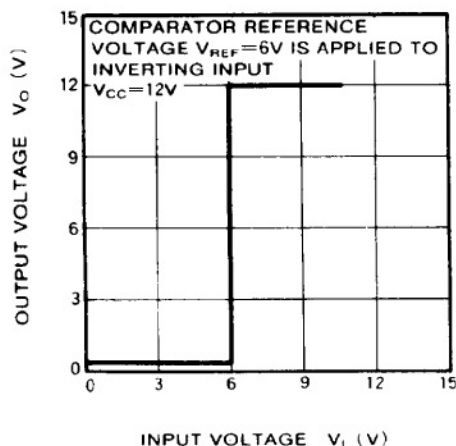

QUAD COMPARATOR

INPUT CURRENT VS. INPUT VOLTAGE

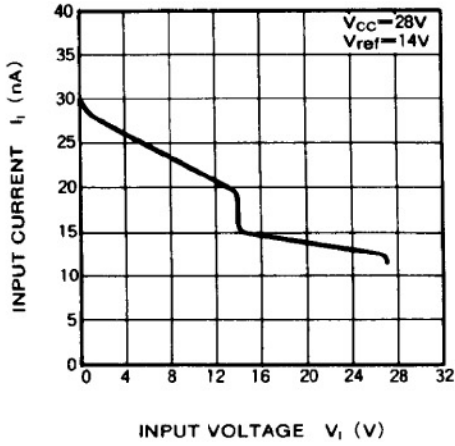

INPUT CURRENT VS. SUPPLY VOLTAGE

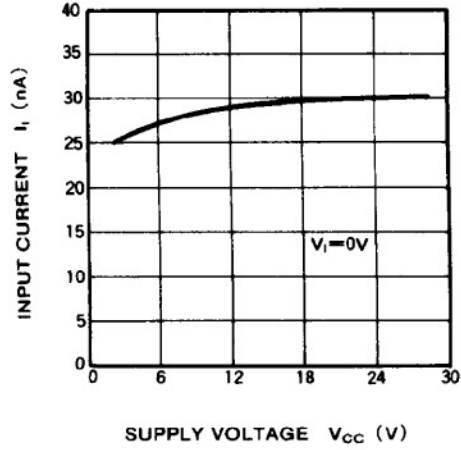

CIRCUIT CURRENT VS. SUPPLY VOLTAGE

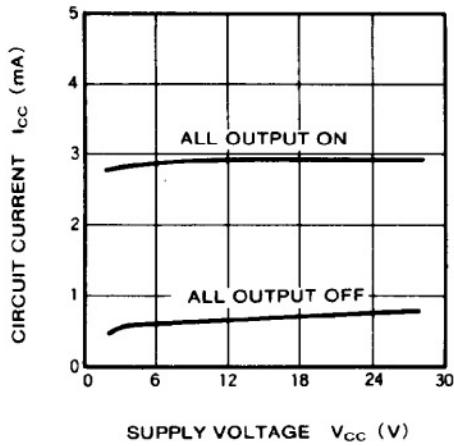

"L" OUTPUT VOLTAGE VS. OUTPUT SINK CURRENT

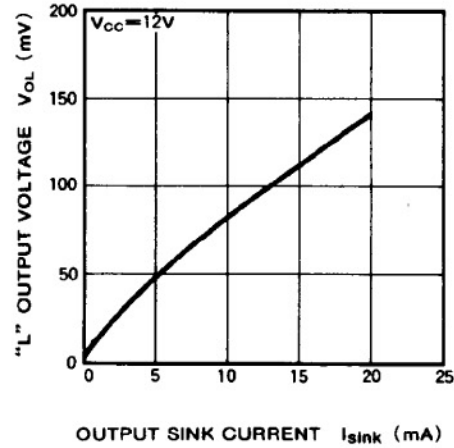

CIRCUIT CURRENT VS. AMBIENT TEMPERATURE

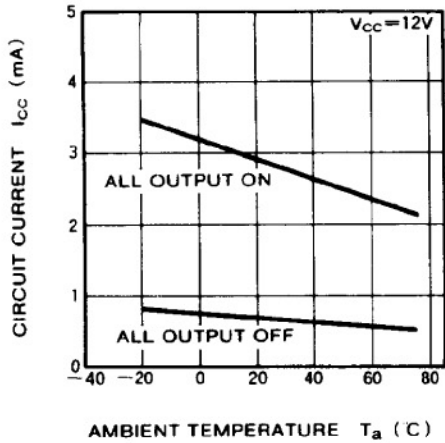

INPUT CURRENT VS. AMBIENT TEMPERATURE

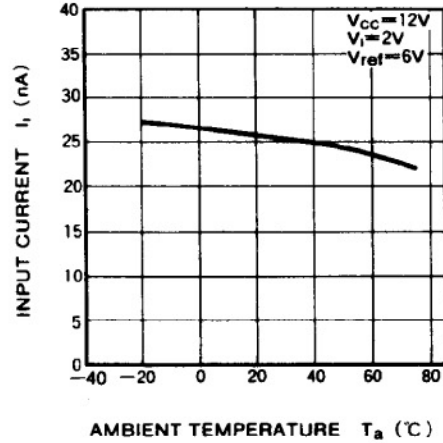

QUAD COMPARATOR

**"L" OUTPUT VOLTAGE VS.
 AMBIENT TEMPERATURE**

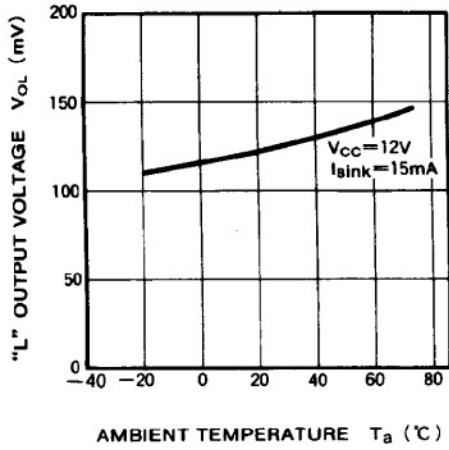

**OUTPUT LEAK CURRENT VS.
 AMBIENT TEMPERATURE**

