

RTAN140X SERIES

TRANSISTOR WITH RESISTOR
FOR MUTING APPLICATION
SILICON NPN EPITAXIAL TYPE

FEATURE

- Built-in bias resistor ($R1=10k\Omega$)
- Small package for easy mounting.
- High reverse hFE
- Small collector to emitter saturation voltage.
 $V_{CE(sat)}=10mV(TYP.)(@I_C=10mA/I_B=0.5mA)$
- Low on Resistance
 $R_{on}=0.94\Omega(TYP.)(@V_I=7V)$

APPLICATION

muting circuit , switching circuit

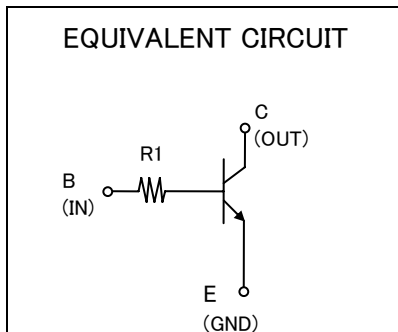

OUTLINE DRAWING

Unit : mm

RTAN140T2 (PRELIMINARY)	RTAN140M
<p>JEITA, JEDEC : — ISAHAYA : T-USM</p> <p>TERMINAL CONNECTOR ① : BASE ② : EMITTER ③ : COLLECTOR</p>	<p>JEITA : SC-70 JEDEC : —</p> <p>TERMINAL CONNECTOR ① : BASE ② : EMITTER ③ : COLLECTOR</p>
<p>JEITA : SC-75A JEDEC : —</p> <p>TERMINAL CONNECTOR ① : BASE ② : EMITTER ③ : COLLECTOR</p>	<p>JEITA : SC-59 JEDEC : Similar to TO-236</p> <p>TERMINAL CONNECTOR ① : BASE ② : EMITTER ③ : COLLECTOR</p>

RTAN140X SERIES

TRANSISTOR WITH RESISTOR
FOR MUTING APPLICATION
SILICON NPN EPITAXIAL TYPE

MAXIMUM RATING (Ta=25°C)

SYMBOL	PARAMETER	RATING				UNIT
		RTAN140T2	RTAN140U	RTAN140M	RTAN140C	
V _{CBO}	Collector to Base voltage	40				V
V _{EBO}	Emitter to Base voltage	40				V
V _{CEO}	Collector to Emitter voltage	20				V
I _C	Collector current	400				mA
P _C	Collector dissipation (Ta=25°C)	125(※)	150	200		mW
T _j	Junction temperature	+125	+150			°C
T _{stg}	Storage temperature	-55~+125	-55~+150			°C

ELECTRICAL CHARACTERISTICS (Ta=25°C)

※package mounted on 9mm × 19mm × 1mm glass-epoxy substrate.

SYMBOL	PARAMETER	TEST CONDITION	LIMIT			UNIT
			MIN	TYP	MAX	
V _{(BR)CBO}	C to B break down voltage	I _C =50 μA, I _E =0mA	40			V
V _{(BR)EBO}	E to B break down voltage	I _E =50 μA, I _C =0mA	40			V
V _{(BR)CEO}	C to E break down voltage	I _C =1mA, R _{BE} =∞	20			V
I _{CBO}	Collector cut off current	V _{CB} =40V, I _E =0mA			0.5	μA
I _{EBO}	Emitter cut off current	V _{EB} =40V, I _C =0mA			0.5	μA
h _{FE}	DC forward current gain	V _{CE} =5V, I _C =10mA	820		2500	—
V _{CE(sat)}	C to E saturation voltage	I _C =10mA, I _B =0.5mA		10		mV
R ₁	Input resistance		7	10	13	kΩ
f _T	Gain band width product	V _{CE} =10V, I _E =-10mA, f=100MHz		35		MHz
R _{ON}	Output "ON" resistance	V _I =7V, R _L =1kΩ		0.94		Ω

TYPICAL CHARACTERISTICS

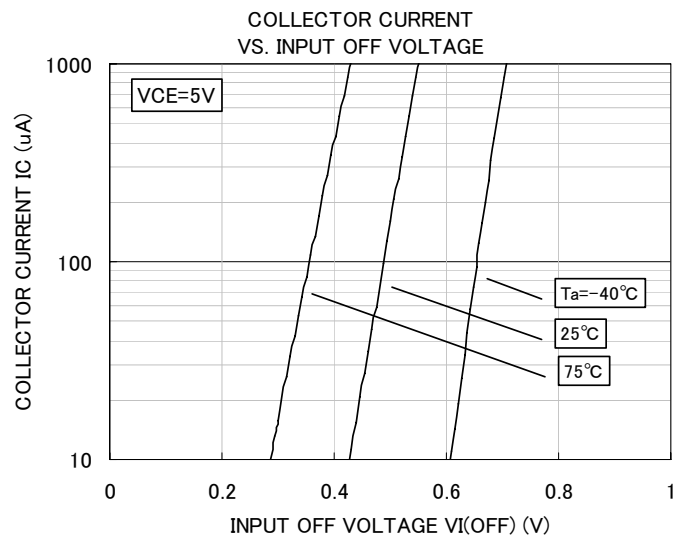
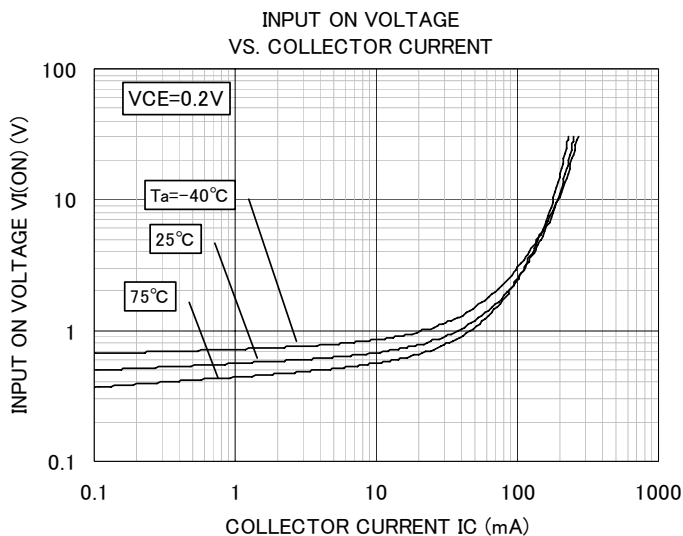

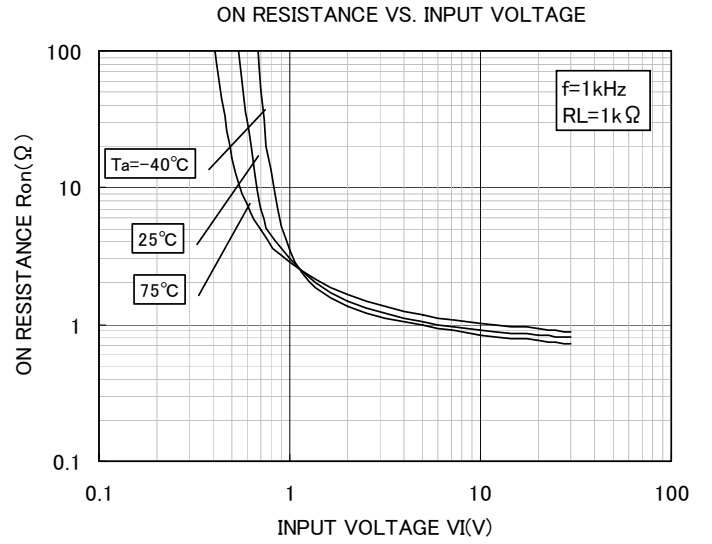
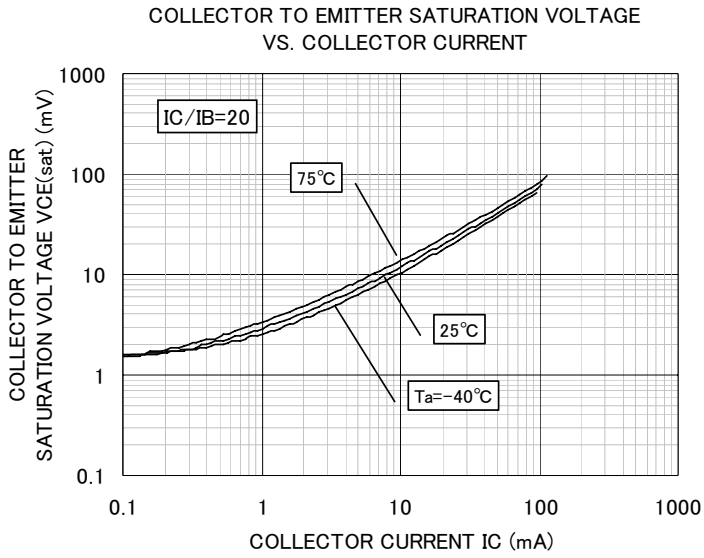
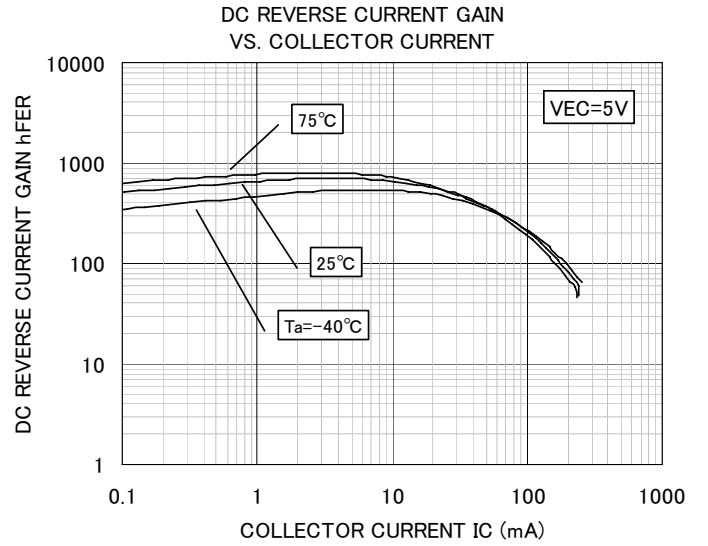
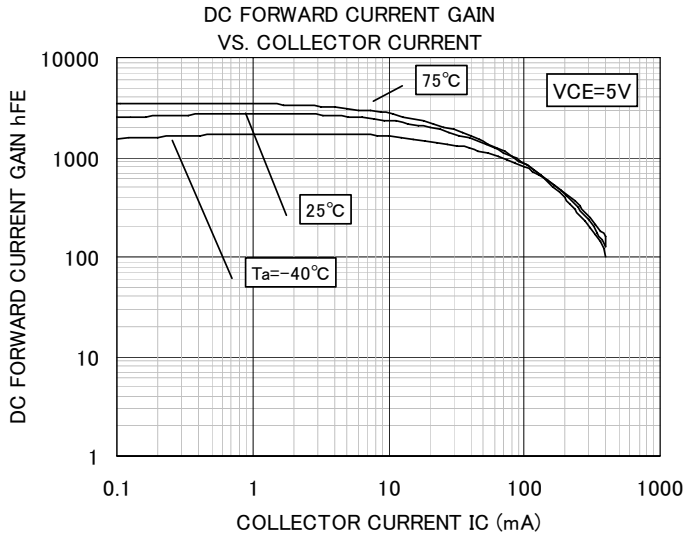



Marketing division, Marketing planning department

6-41 Tsukuba, Isahaya, Nagasaki, 854-0065 Japan

Keep safety first in your circuit designs!

•ISAHAYA Electronics Corporation puts the maximum effort into making semiconductor products better and more reliable, but there is always the possibility that trouble may occur with them. Trouble with semiconductors may lead to personal injury, fire or property damage. Remember to give due consideration to safety when making your circuit designs, with appropriate measures such as (1) placement of substitutive, auxiliary, (2) use of non-flammable material or (3) prevention against any malfunction or mishap.

Notes regarding these materials

- These materials are intended as a reference to our customers in the selection of the ISAHAYA products best suited to the customer's application; they don't convey any license under any intellectual property rights, or any other rights, belonging ISAHAYA or third party.
- ISAHAYA Electronics Corporation assumes no responsibility for any damage, or infringement of any third party's rights, originating in the use of any product data, diagrams, charts or circuit application examples contained in these materials.
- All information contained in these materials, including product data, diagrams and charts, represent information on products at the time of publication of these materials, and are subject to change by ISAHAYA Electronics Corporation without notice due to product improvements or other reasons. It is therefore recommended that customers contact ISAHAYA Electronics Corporation or an authorized ISAHAYA products distributor for the latest product information before purchasing product listed herein.
- ISAHAYA Electronics Corporation products are not designed or manufactured for use in a device or system that is used under circumstances in which human life is potentially at stake. Please contact ISAHAYA electronics corporation or an authorized ISAHAYA products distributor when considering the use of a product contained herein for any specific purposes, such as apparatus or systems for transportation, vehicular, medical, aerospace, nuclear, or undersea repeater use.
- The prior written approval of ISAHAYA Electronics Corporation is necessary to reprint or reproduce in whole or in part these materials.
- If these products or technologies are subject to the Japanese export control restrictions, they must be exported under a license from the Japanese government and cannot be imported into a country other than the approved destination. Any diversion or re-export contrary to the export control laws and regulations of Japan and/or the country of destination is prohibited.
- Please contact ISAHAYA Electronics Corporation or authorized ISAHAYA products distributor for further details on these materials or the products contained therein.