

# RQA0002DNS

## Silicon N-Channel MOS FET

REJ03G0583-0301

Rev.3.01

Nov 21, 2007

### Features

- High output power, High gain, High efficiency  
Pout = +39.6 dBm, Linear gain = 20 dB, PAE = 68% (f = 520 MHz)
- Small outline package (WSON0504-2: 5.0 × 4.0 × 0.8 mm)

### Outline

RENESAS Package code: PWSN0002ZA-B  
(Package name: HWSN-2 <WSON0504-2>)

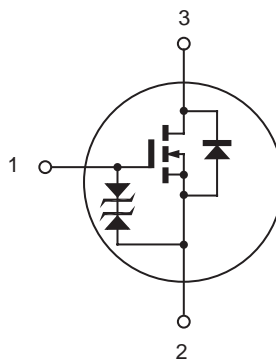
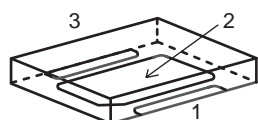
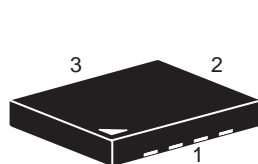

1. Gate  
2. Source  
3. Drain

Note: Marking is "RQA0002".

### Absolute Maximum Ratings

(Ta = 25°C)

Item	Symbol	Ratings	Unit
Drain to source voltage	V <sub>DSS</sub>	16	V
Gate to source voltage	V <sub>GSS</sub>	±5	V
Drain current	I <sub>D</sub>	3.8	A
Channel dissipation	P <sub>ch</sub> <sup>Note</sup>	15	W
Channel temperature	T <sub>ch</sub>	150	°C
Storage temperature	T <sub>stg</sub>	-55 to +150	°C

Note: Value at T<sub>c</sub> = 25°C

This Device is sensitive to electro static discharge. An Adequate careful handling procedure is requested.

### Electrical Characteristics

(Ta = 25°C)

Item	Symbol	Min.	Typ	Max.	Unit	Test Conditions
Zero gate voltage drain current	$I_{DSS}$	—	—	20	$\mu A$	$V_{DS} = 16 V, V_{GS} = 0$
Gate to source leak current	$I_{GSS}$	—	—	$\pm 3$	$\mu A$	$V_{GS} = \pm 5 V, V_{DS} = 0$
Gate to source cutoff voltage	$V_{GS(off)}$	0.25	0.4	0.75	V	$I_D = 1 mA, V_{DS} = 7.5 V$
Forward transfer admittance	$ y_{fs} $	4.0	4.8	5.8	S	$V_{DS} = 7.5 V, I_D = 2 A$
Input capacitance	$C_{iss}$	—	102	—	pF	$V_{GS} = 5 V, V_{DS} = 0, f = 1 MHz$
Output capacitance	$C_{oss}$	—	50	—	pF	$V_{DS} = 7.5 V, V_{GS} = 0, f = 1 MHz$
Reverse transfer capacitance	$C_{rss}$	—	4.5	—	pF	$V_{DG} = 7.5 V, V_{GS} = 0, f = 1 MHz$
Output power	$P_{out}$	38.7	39.6	—	dBm	$V_{DS} = 7.5 V, I_{DQ} = 200 mA$ $f = 520 MHz,$ $P_{in} = +25 dBm (316 mW)$
		7.41	9.12	—	W	
Power added efficiency	PAE	60	68	—	%	
Output power	$P_{out}$	—	35.8	—	dBm	$V_{DS} = 3.6 V, I_{DQ} = 200 mA$ $f = 520 MHz,$ $P_{in} = +25 dBm (316 mW)$
		—	3.8	—	W	
Power added efficiency	PAE	—	60	—	%	

### Main Characteristics

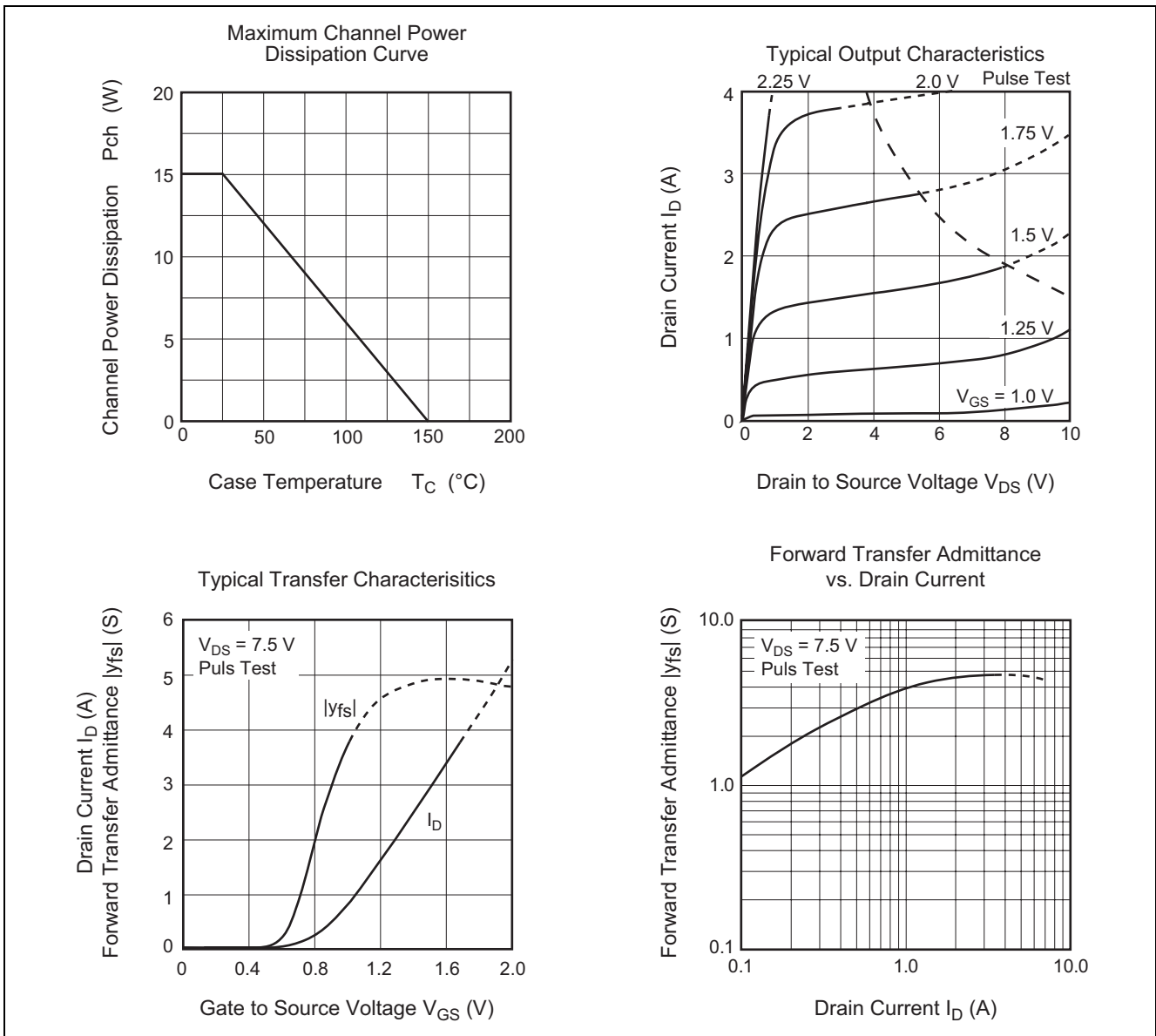

Input Capacitance vs.  
Gate to Source Voltage

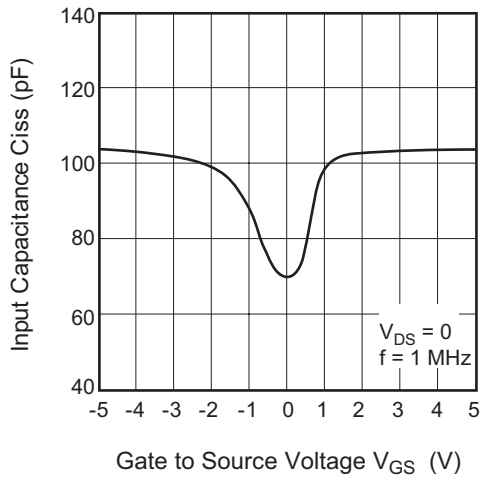

Output Capacitance vs.  
Drain to Source Voltage

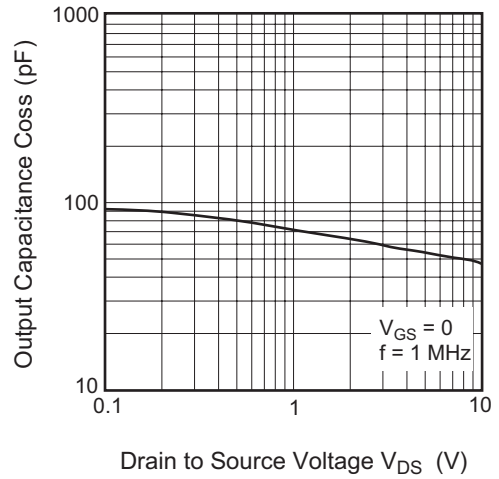

Reverse Transfer Capacitance vs.  
Drain to Gate Voltage

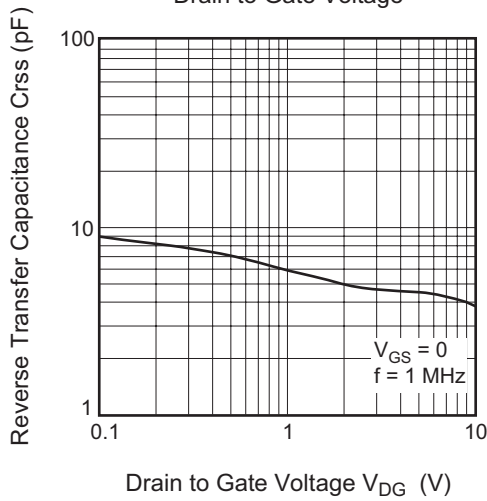

Maximum Stable Gain,  $|S_{21}|^2$   
vs. Drain Current

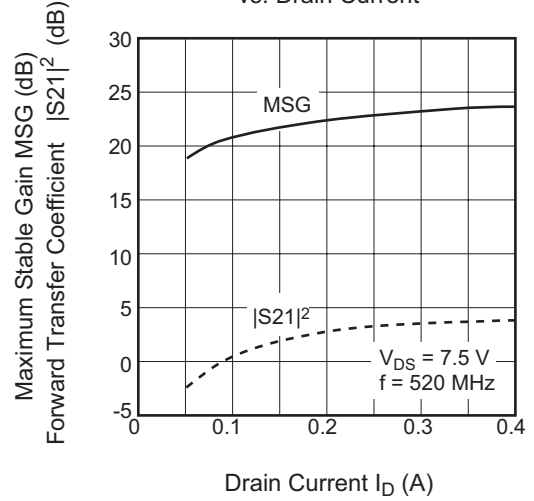

## Evaluation Circuit ( @ $V_{DD} = 7.5V$ Tuning, $f = 520$ MHz )

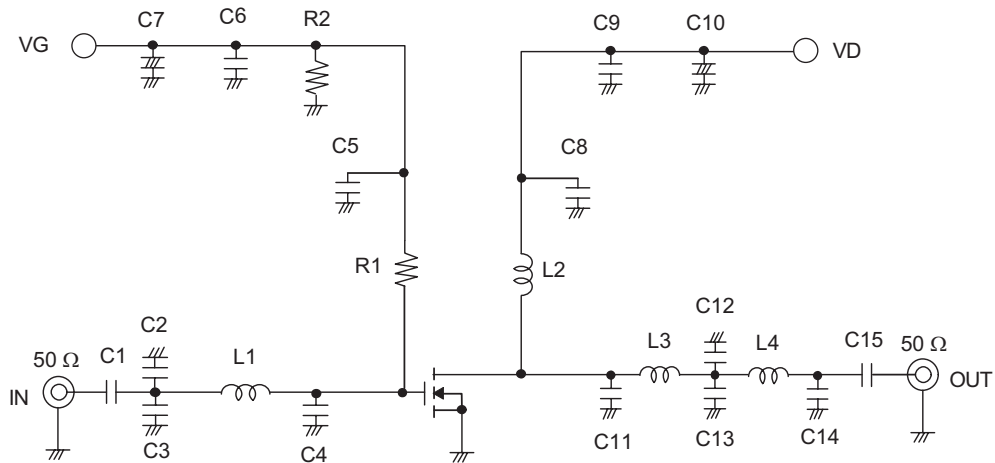

C1, C6, C9, C15:	1000 pF Chip Capacitor
C2:	4 pF Chip Capacitor
C3:	15 pF Chip Capacitor
C4, C11:	5 pF Chip Capacitor
C5, C8:	100pF Chip Capacitor
C7, C10:	1 $\mu$ F Electrolysis Capacitor
C12, C14:	10 pF Chip Capacitor
C13:	7 pF Chip Capacitor
L1:	1.8 nH Chip Inductor
L2:	8 Turns D : 0.5 mm, $\phi$ 2.4 mm Enamel Wire
L3:	1.0 nH Chip Inductor
L4:	1.5 nH Chip Inductor
R1:	6.8 k $\Omega$ Chip Resistor
R2:	40 k $\Omega$ Chip Resistor

Output Power, Drain Current vs. Input Power

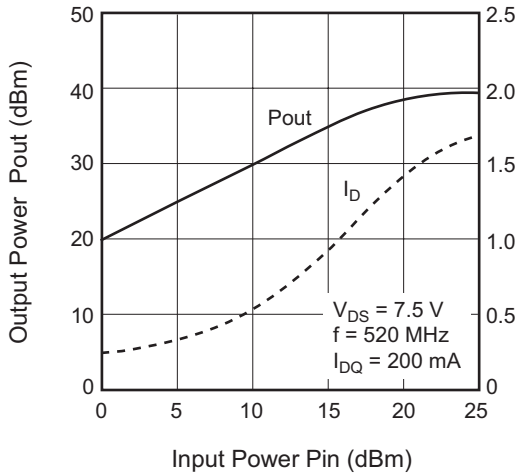

Power Gain, Power Added Efficiency vs. Input Power

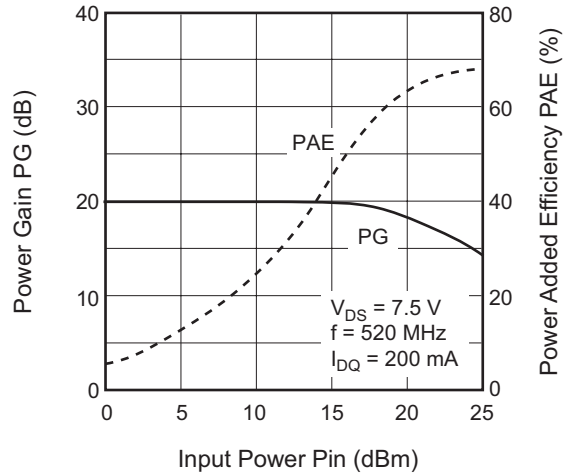

Power Gain, Power Added Efficiency vs. Frequency

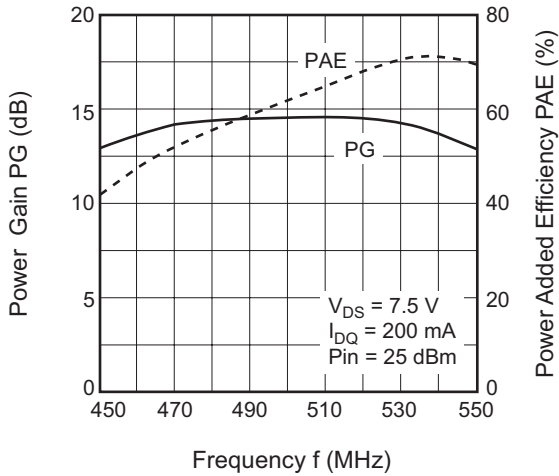

Input Return Loss vs. Frequency

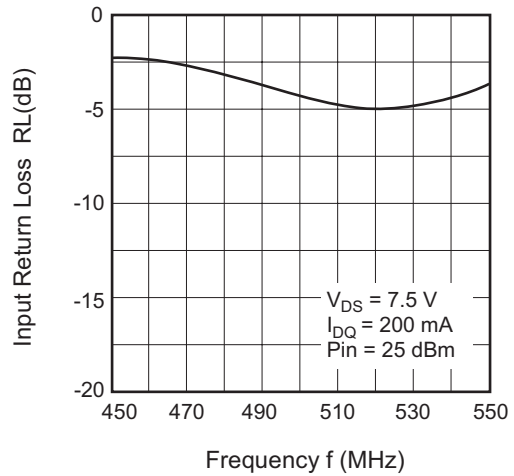

Power Gain, Power Added Efficiency, vs. Drain to Source Voltage

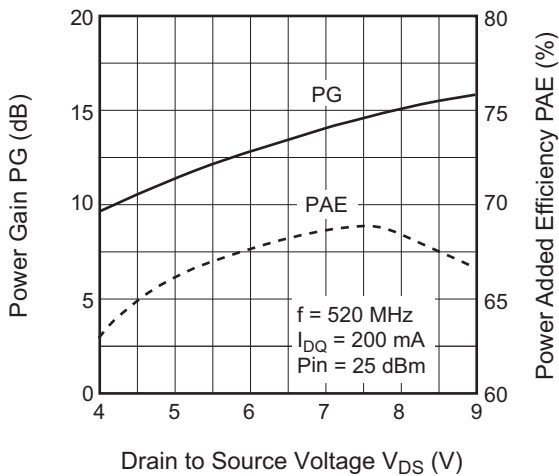

Power Gain, Power Added Efficiency vs. Idling Current

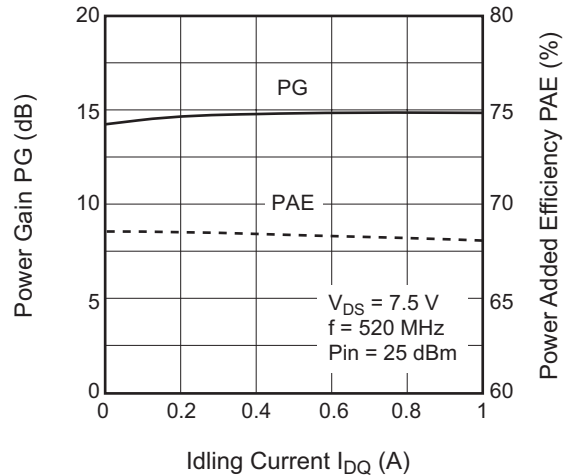

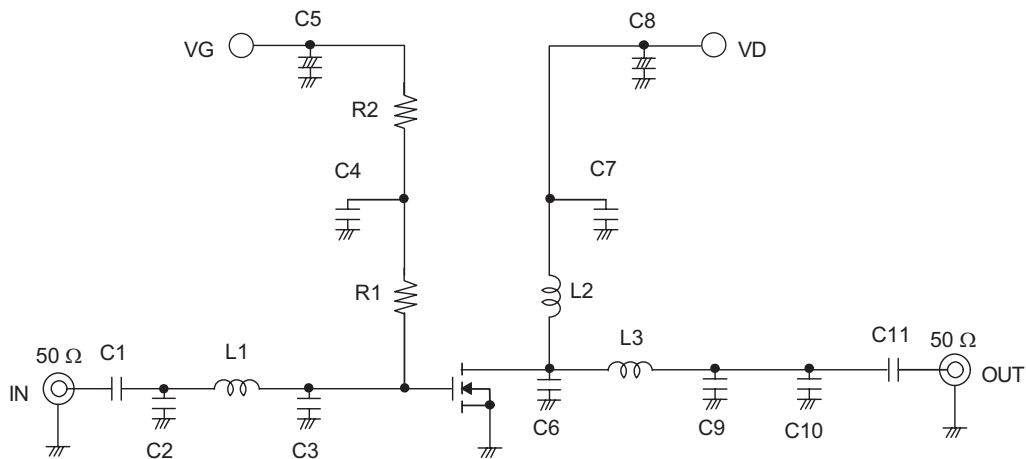
Evaluation Circuit 2 ( @ $V_{DD} = 3.6V$  Tuning,  $f = 520$  MHz )

- C1, C11: 1000 pF Chip Capacitor
- C2: 20 pF Chip Capacitor
- C3, C10: 10 pF Chip Capacitor
- C4, C7: 100 pF Chip Capacitor
- C5, C8: 1  $\mu$ F Electrolysis Capacitor
- C6: 5 pF Chip Capacitor
- C9: 27 pF Chip Capacitor
- L1: 1.5 nH Chip Inductor
- L2: 8 Turns D : 0.5 mm ,  $\phi$ 2.4 mm Enamel Wire
- L3: 1.2 nH Chip Inductor
- R1: 200  $\Omega$  Chip Resistor
- R2: 3 k $\Omega$  Chip Resistor

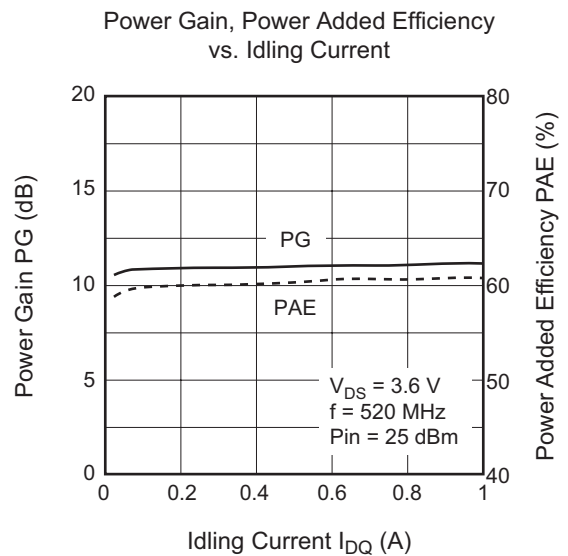
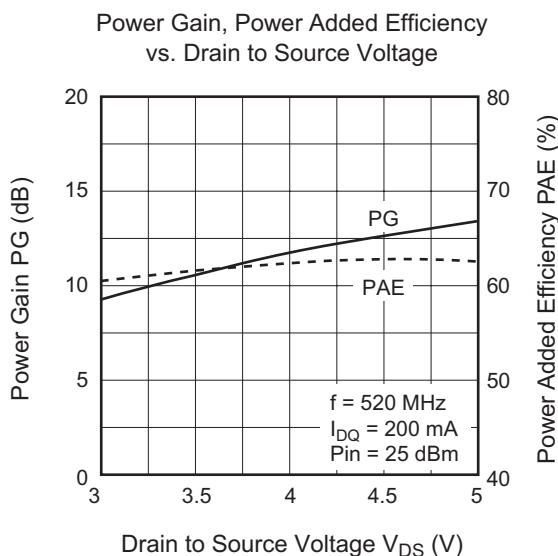
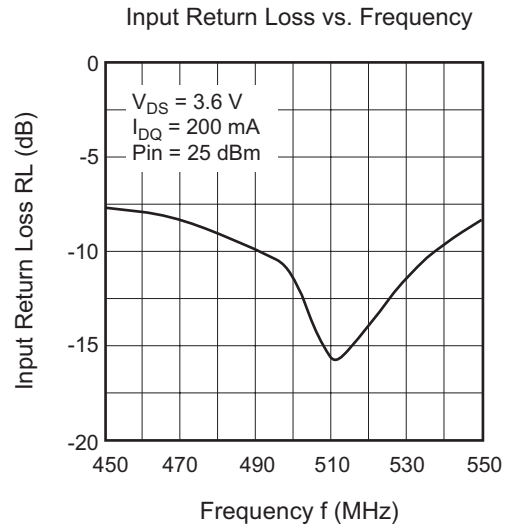
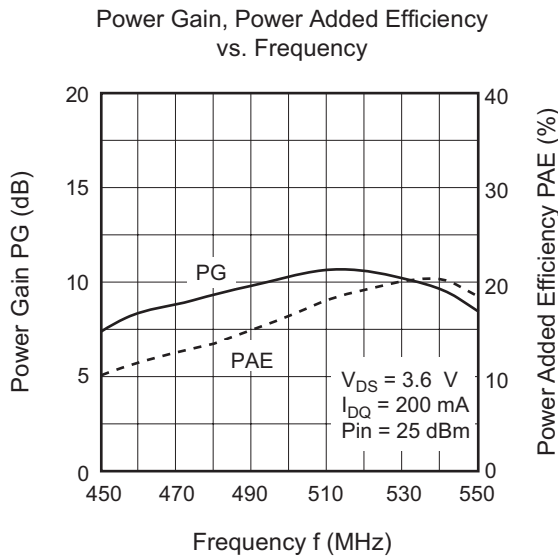
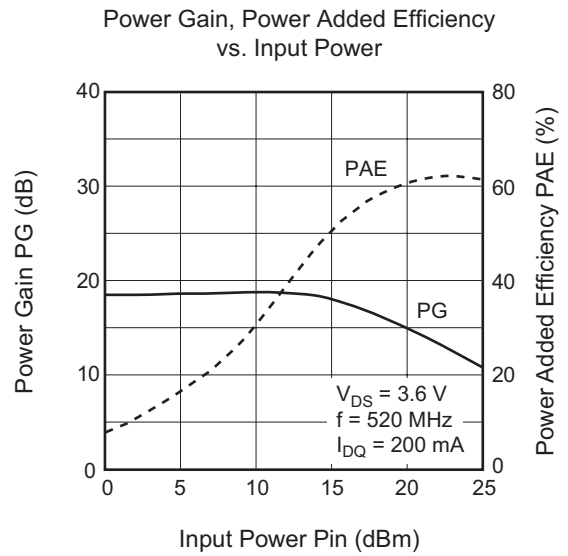
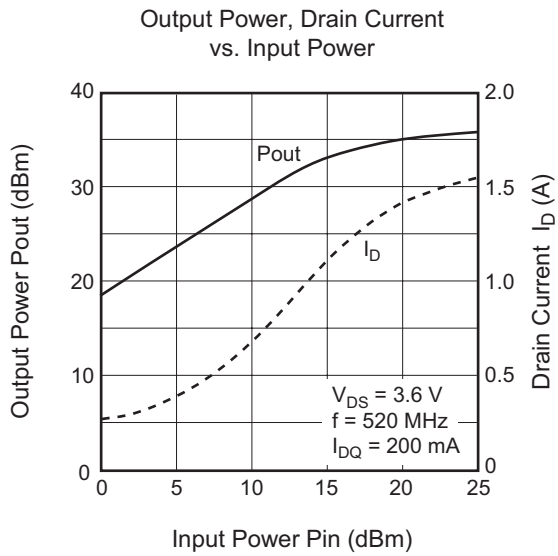

S<sub>11</sub> Parameter vs. Frequency

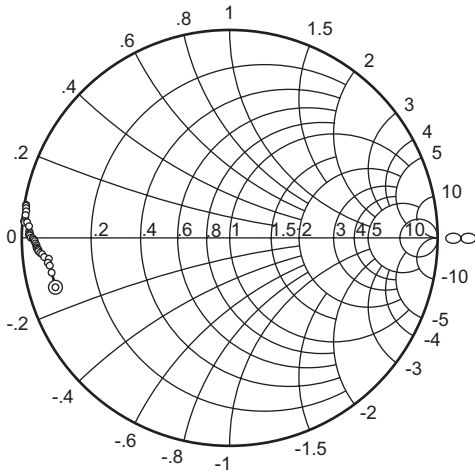

Condition:  $V_{DS} = 7.5\text{ V}$ ,  $I_{DQ} = 200\text{ mA}$ ,  $Z_0 = 50\ \Omega$   
 100 to 1000 MHz (50 MHz Step)  
 1000 to 2500 MHz (100 MHz Step)

S<sub>21</sub> Parameter vs. Frequency

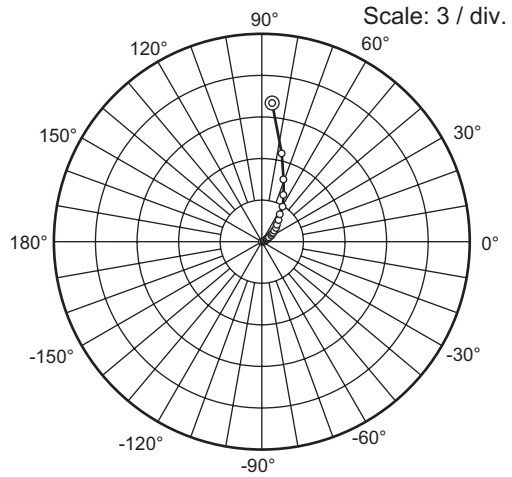

Condition:  $V_{DS} = 7.5\text{ V}$ ,  $I_{DQ} = 200\text{ mA}$ ,  $Z_0 = 50\ \Omega$   
 100 to 1000 MHz (50 MHz Step)  
 1000 to 2500 MHz (100 MHz Step)

S<sub>12</sub> Parameter vs. Frequency

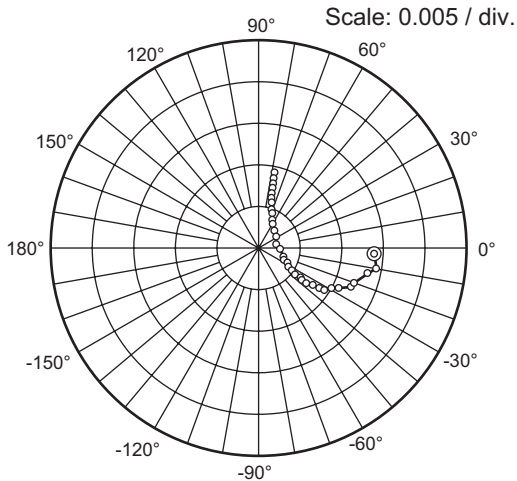

Condition:  $V_{DS} = 7.5\text{ V}$ ,  $I_{DQ} = 200\text{ mA}$ ,  $Z_0 = 50\ \Omega$   
 100 to 1000 MHz (50 MHz Step)  
 1000 to 2500 MHz (100 MHz Step)

S<sub>22</sub> Parameter vs. Frequency

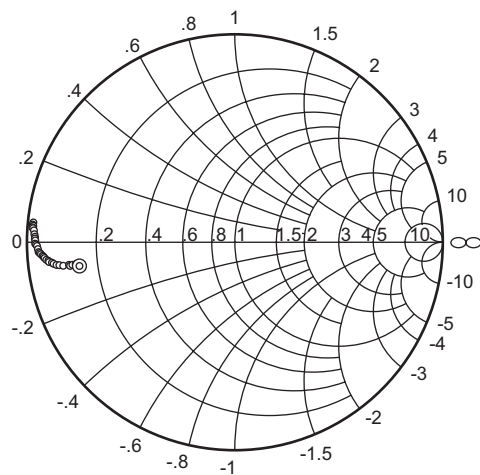

Condition:  $V_{DS} = 7.5\text{ V}$ ,  $I_{DQ} = 200\text{ mA}$ ,  $Z_0 = 50\ \Omega$   
 100 to 1000 MHz (50 MHz Step)  
 1000 to 2500 MHz (100 MHz Step)



## S parameter

(V<sub>DS</sub> = 3.6 V, I<sub>D</sub> = 200 mA, Z<sub>o</sub> = 50 Ω)

f (MHz)	S11		S21		S12		S22	
	MAG	ANG (deg.)	MAG	ANG (deg.)	MAG	ANG (deg.)	MAG	ANG (deg.)
100	0.861	-166.1	9.02	82.8	0.016	-1.9	0.774	-171.0
150	0.865	-169.7	5.92	74.0	0.016	-13.1	0.788	-171.9
200	0.876	-171.3	4.30	67.4	0.014	-18.3	0.805	-171.8
250	0.883	-172.3	3.29	61.4	0.013	-23.9	0.823	-171.9
300	0.880	-173.1	2.62	56.0	0.013	-27.2	0.824	-172.1
350	0.903	-174.0	2.09	51.4	0.011	-31.8	0.855	-172.4
400	0.915	-174.5	1.72	47.2	0.011	-33.5	0.872	-172.6
450	0.920	-175.0	1.45	43.3	0.010	-38.2	0.886	-172.9
500	0.930	-175.5	1.24	39.8	0.009	-38.5	0.895	-173.4
550	0.935	-176.0	1.06	36.7	0.008	-40.6	0.906	-173.9
600	0.937	-176.4	0.92	33.8	0.007	-41.7	0.914	-174.4
650	0.941	-176.9	0.81	31.2	0.007	-40.9	0.920	-174.7
700	0.941	-177.5	0.71	28.7	0.006	-41.0	0.928	-175.1
750	0.944	-177.9	0.64	26.4	0.005	-41.0	0.934	-175.6
800	0.951	-178.6	0.57	24.4	0.005	-40.3	0.937	-176.0
850	0.952	-179.2	0.51	22.4	0.004	-40.1	0.942	-176.5
900	0.959	-179.6	0.46	21.2	0.004	-33.9	0.945	-177.0
950	0.966	-179.9	0.42	19.8	0.003	-31.0	0.951	-177.3
1000	0.968	-179.8	0.38	18.7	0.003	-25.8	0.954	-177.7
1050	0.969	179.8	0.34	17.5	0.003	-16.0	0.956	-178.0
1100	0.972	179.8	0.32	16.3	0.002	-9.2	0.957	-178.5
1150	0.972	179.7	0.29	15.2	0.002	2.2	0.962	-178.8
1200	0.974	179.4	0.27	14.3	0.002	9.9	0.962	-179.2
1250	0.974	179.2	0.25	13.2	0.002	24.6	0.963	-179.6
1300	0.975	178.9	0.23	12.1	0.002	33.5	0.965	-179.7
1350	0.973	178.6	0.21	11.1	0.002	43.3	0.966	-180.0
1400	0.971	178.2	0.20	9.9	0.003	48.3	0.967	179.8
1450	0.968	177.5	0.19	9.0	0.003	55.8	0.968	179.4
1500	0.970	176.8	0.17	8.0	0.003	62.8	0.967	179.1
1550	0.979	176.5	0.17	7.4	0.004	65.0	0.967	178.9
1600	0.990	175.9	0.16	7.0	0.004	67.1	0.968	178.4
1650	0.995	175.9	0.15	6.9	0.004	68.7	0.968	178.3
1700	0.999	175.8	0.14	6.6	0.004	71.0	0.969	177.9
1750	0.999	175.8	0.13	6.2	0.005	72.3	0.969	177.6
1800	0.999	175.7	0.13	6.2	0.005	74.8	0.972	177.3
1850	0.999	175.7	0.12	6.3	0.005	75.0	0.970	177.0
1900	0.999	175.6	0.12	6.4	0.006	75.5	0.971	176.7
1950	0.999	175.3	0.11	6.4	0.006	75.2	0.972	176.4
2000	0.999	174.9	0.10	6.4	0.006	75.4	0.974	176.2
2050	0.999	174.4	0.10	6.3	0.006	78.5	0.975	175.9
2100	0.999	173.7	0.09	5.9	0.007	78.0	0.975	175.7
2150	0.999	173.0	0.09	5.2	0.007	78.0	0.979	175.5
2200	0.999	172.4	0.09	4.9	0.007	77.6	0.980	175.4
2250	0.999	172.2	0.08	4.2	0.008	78.2	0.979	175.1
2300	0.999	171.5	0.08	4.0	0.008	78.6	0.978	174.9
2350	0.999	171.2	0.08	3.2	0.008	78.8	0.983	174.7
2400	0.999	171.0	0.08	3.3	0.009	79.3	0.979	174.6
2450	0.999	171.2	0.07	2.7	0.009	78.9	0.978	174.4
2500	0.999	170.8	0.07	3.3	0.009	78.7	0.980	174.1

## S parameter

 $(V_{DS} = 6\text{ V}, I_D = 200\text{ mA}, Z_o = 50\ \Omega)$ 

f (MHz)	S11		S21		S12		S22	
	MAG	ANG (deg.)	MAG	ANG (deg.)	MAG	ANG (deg.)	MAG	ANG (deg.)
100	0.869	-165.2	9.86	83.9	0.016	-1.6	0.758	-170.4
150	0.872	-169.3	6.45	75.2	0.015	-10.6	0.773	-171.4
200	0.878	-171.1	4.68	68.4	0.014	-17.0	0.791	-171.3
250	0.887	-172.2	3.59	62.7	0.013	-23.2	0.808	-171.2
300	0.882	-173.2	2.87	57.1	0.012	-26.0	0.811	-171.6
350	0.907	-173.9	2.29	52.6	0.011	-30.3	0.843	-171.7
400	0.915	-174.6	1.90	48.4	0.010	-32.0	0.861	-172.0
450	0.922	-174.9	1.60	44.4	0.009	-36.7	0.874	-172.3
500	0.932	-175.2	1.37	41.1	0.009	-37.5	0.885	-172.9
550	0.933	-175.9	1.18	37.8	0.008	-39.5	0.897	-173.3
600	0.937	-176.4	1.02	35.2	0.007	-40.4	0.905	-173.6
650	0.940	-176.8	0.90	32.5	0.007	-39.4	0.912	-174.0
700	0.941	-177.4	0.79	29.8	0.006	-38.9	0.922	-174.5
750	0.946	-178.0	0.71	27.4	0.005	-40.1	0.927	-174.9
800	0.947	-178.4	0.63	25.1	0.005	-38.9	0.931	-175.4
850	0.955	-179.2	0.57	23.7	0.004	-37.9	0.936	-175.9
900	0.961	-179.8	0.52	21.9	0.004	-32.8	0.941	-176.3
950	0.967	-180.0	0.47	20.6	0.003	-29.5	0.946	-176.7
1000	0.968	-179.9	0.42	19.7	0.003	-26.7	0.949	-177.2
1050	0.969	179.6	0.38	18.3	0.003	-17.2	0.951	-177.6
1100	0.972	179.8	0.35	17.1	0.002	-10.4	0.954	-178.0
1150	0.971	179.7	0.33	15.9	0.002	4.4	0.956	-178.3
1200	0.975	179.5	0.30	15.0	0.002	9.0	0.959	-178.6
1250	0.973	179.3	0.28	14.0	0.002	19.7	0.959	-179.0
1300	0.974	178.9	0.26	12.8	0.002	34.9	0.962	-179.2
1350	0.973	178.8	0.24	11.8	0.002	41.8	0.965	-179.5
1400	0.971	178.3	0.22	10.5	0.003	48.9	0.963	-179.8
1450	0.968	177.7	0.21	9.5	0.003	55.0	0.965	179.9
1500	0.971	177.2	0.20	8.4	0.003	60.4	0.964	179.6
1550	0.975	176.6	0.19	7.8	0.003	63.0	0.966	179.4
1600	0.993	176.1	0.18	7.3	0.004	63.7	0.966	178.9
1650	0.997	175.8	0.17	7.1	0.004	67.9	0.966	178.8
1700	0.999	175.9	0.16	6.7	0.004	69.2	0.967	178.4
1750	0.999	175.8	0.15	6.6	0.004	70.5	0.967	178.0
1800	0.999	175.8	0.14	6.5	0.005	72.7	0.970	177.7
1850	0.999	175.9	0.14	6.4	0.005	74.6	0.969	177.3
1900	0.999	175.9	0.13	6.9	0.006	75.6	0.969	177.1
1950	0.999	175.4	0.12	6.5	0.006	75.6	0.971	176.8
2000	0.999	174.9	0.12	6.3	0.006	76.7	0.972	176.5
2050	0.999	174.6	0.11	6.5	0.006	78.5	0.973	176.3
2100	0.999	173.8	0.11	5.9	0.007	78.2	0.974	176.0
2150	0.999	173.1	0.10	5.0	0.007	77.7	0.978	175.8
2200	0.999	172.6	0.10	4.8	0.007	77.4	0.979	175.8
2250	0.999	172.1	0.09	3.8	0.008	78.2	0.977	175.5
2300	0.999	171.7	0.09	3.4	0.008	77.3	0.978	175.1
2350	0.999	171.2	0.09	2.9	0.008	78.4	0.982	175.1
2400	0.999	171.1	0.08	2.9	0.008	78.9	0.978	174.9
2450	0.999	171.1	0.08	2.5	0.009	78.5	0.978	174.7
2500	0.999	171.1	0.08	2.7	0.009	78.4	0.979	174.4

## S parameter

 $(V_{DS} = 7.2 \text{ V}, I_D = 200 \text{ mA}, Z_o = 50 \Omega)$ 

f (MHz)	S11		S21		S12		S22	
	MAG	ANG (deg.)	MAG	ANG (deg.)	MAG	ANG (deg.)	MAG	ANG (deg.)
100	0.875	-164.1	10.08	85.2	0.015	-0.6	0.757	-170.9
150	0.877	-168.9	6.59	76.3	0.014	-9.4	0.771	-171.7
200	0.884	-170.8	4.78	69.7	0.013	-16.3	0.787	-171.5
250	0.892	-172.0	3.69	63.7	0.012	-20.8	0.804	-171.5
300	0.887	-173.0	2.95	58.3	0.012	-23.6	0.807	-171.7
350	0.908	-173.9	2.35	53.8	0.011	-28.4	0.838	-171.7
400	0.917	-174.4	1.96	49.4	0.010	-30.7	0.854	-172.0
450	0.922	-174.8	1.66	45.8	0.010	-34.6	0.869	-172.3
500	0.931	-175.3	1.42	42.4	0.009	-35.9	0.880	-172.7
550	0.934	-176.0	1.23	39.3	0.008	-38.4	0.893	-173.2
600	0.939	-176.2	1.06	36.3	0.007	-38.5	0.902	-173.6
650	0.943	-176.8	0.93	33.4	0.007	-38.9	0.908	-173.9
700	0.944	-177.4	0.83	31.0	0.006	-36.6	0.917	-174.4
750	0.948	-177.8	0.74	28.4	0.005	-38.0	0.925	-174.8
800	0.949	-178.5	0.66	26.5	0.005	-37.0	0.928	-175.3
850	0.953	-179.1	0.60	24.7	0.004	-36.2	0.933	-175.7
900	0.963	-179.6	0.54	23.3	0.004	-30.7	0.938	-176.2
950	0.972	-179.8	0.50	21.7	0.003	-29.5	0.944	-176.6
1000	0.968	-179.9	0.45	20.3	0.003	-25.6	0.947	-176.9
1050	0.969	180.0	0.41	19.4	0.003	-13.4	0.949	-177.4
1100	0.970	179.8	0.37	18.0	0.002	-7.9	0.953	-177.8
1150	0.972	179.6	0.34	16.8	0.002	3.2	0.955	-178.2
1200	0.975	179.6	0.32	15.8	0.002	8.7	0.958	-178.5
1250	0.975	179.4	0.29	14.8	0.002	24.7	0.958	-178.9
1300	0.977	179.0	0.27	13.5	0.002	33.6	0.960	-179.1
1350	0.972	178.7	0.25	12.4	0.002	43.9	0.962	-179.3
1400	0.972	178.3	0.23	11.2	0.003	45.9	0.963	-179.6
1450	0.967	177.6	0.22	10.0	0.003	53.6	0.963	-180.0
1500	0.971	177.1	0.21	9.0	0.003	61.2	0.963	179.8
1550	0.979	176.6	0.20	8.4	0.003	63.4	0.964	179.5
1600	0.988	176.2	0.19	7.8	0.004	65.1	0.964	179.0
1650	0.996	176.0	0.18	7.6	0.004	68.0	0.965	178.9
1700	0.998	175.7	0.17	7.1	0.004	69.1	0.965	178.5
1750	0.999	175.8	0.16	6.9	0.005	72.3	0.965	178.2
1800	0.999	175.8	0.15	6.8	0.005	72.6	0.969	177.8
1850	0.999	175.9	0.14	6.6	0.005	74.8	0.968	177.5
1900	0.999	175.9	0.14	6.9	0.006	74.8	0.968	177.2
1950	0.999	175.3	0.13	6.6	0.006	76.7	0.970	176.9
2000	0.999	175.0	0.12	6.7	0.006	76.3	0.972	176.7
2050	0.999	174.5	0.12	6.6	0.006	77.7	0.973	176.5
2100	0.999	173.7	0.11	6.2	0.007	76.2	0.974	176.1
2150	0.999	173.1	0.11	5.4	0.007	78.1	0.978	175.9
2200	0.999	172.5	0.10	4.7	0.007	76.9	0.977	175.9
2250	0.999	172.2	0.10	3.9	0.008	78.0	0.977	175.5
2300	0.999	171.7	0.10	3.3	0.008	76.4	0.977	175.2
2350	0.999	171.2	0.09	2.7	0.008	78.6	0.981	175.2
2400	0.999	171.0	0.09	2.7	0.008	79.3	0.978	175.1
2450	0.999	171.1	0.09	2.3	0.009	78.2	0.977	174.8
2500	0.999	170.9	0.08	2.5	0.009	78.6	0.978	174.5

## S parameter

 $(V_{DS} = 7.5 \text{ V}, I_D = 50 \text{ mA}, Z_o = 50 \Omega)$ 

f (MHz)	S11		S21		S12		S22	
	MAG	ANG (deg.)	MAG	ANG (deg.)	MAG	ANG (deg.)	MAG	ANG (deg.)
100	0.823	-154.9	7.70	78.6	0.029	-10.5	0.659	-153.1
150	0.844	-160.8	4.82	66.1	0.027	-23.3	0.715	-156.5
200	0.865	-163.9	3.33	56.7	0.023	-31.6	0.767	-158.5
250	0.887	-166.2	2.44	49.1	0.021	-39.6	0.809	-160.5
300	0.891	-168.1	1.86	42.6	0.019	-44.9	0.829	-162.7
350	0.922	-169.6	1.42	37.5	0.016	-49.4	0.869	-164.4
400	0.932	-171.0	1.14	33.1	0.015	-52.4	0.893	-165.9
450	0.941	-172.0	0.93	29.4	0.013	-56.4	0.908	-167.3
500	0.949	-173.1	0.77	26.1	0.012	-58.1	0.920	-168.6
550	0.953	-173.8	0.65	23.5	0.011	-59.9	0.931	-169.7
600	0.955	-174.4	0.54	21.0	0.009	-61.1	0.939	-170.7
650	0.955	-175.4	0.47	18.8	0.008	-62.3	0.944	-171.6
700	0.957	-176.2	0.41	16.6	0.007	-61.7	0.950	-172.3
750	0.965	-176.8	0.36	14.7	0.007	-62.9	0.955	-173.1
800	0.962	-177.6	0.32	13.1	0.006	-62.2	0.958	-173.8
850	0.969	-178.3	0.28	11.5	0.005	-63.0	0.961	-174.5
900	0.973	-178.8	0.26	10.9	0.004	-60.5	0.963	-175.1
950	0.979	-179.3	0.23	9.6	0.004	-58.6	0.967	-175.6
1000	0.977	-179.2	0.21	8.9	0.003	-57.6	0.969	-176.2
1050	0.982	-179.7	0.19	7.9	0.002	-53.5	0.969	-176.7
1100	0.984	180.0	0.17	7.2	0.002	-46.6	0.971	-177.2
1150	0.982	179.7	0.16	6.3	0.002	-38.0	0.973	-177.5
1200	0.982	179.6	0.15	5.8	0.001	-27.7	0.975	-177.9
1250	0.983	179.5	0.13	5.1	0.001	-1.9	0.975	-178.4
1300	0.984	179.1	0.12	4.2	0.001	21.6	0.976	-178.6
1350	0.986	178.9	0.12	3.5	0.001	37.7	0.977	-178.9
1400	0.987	178.6	0.11	2.9	0.002	47.3	0.978	-179.2
1450	0.987	177.9	0.10	2.2	0.002	56.0	0.977	-179.6
1500	0.989	177.1	0.09	1.4	0.002	64.7	0.976	180.0
1550	0.989	176.5	0.09	0.8	0.003	69.3	0.977	179.7
1600	0.989	175.9	0.08	0.9	0.003	71.4	0.977	179.3
1650	0.999	175.8	0.08	1.3	0.003	73.5	0.976	179.2
1700	0.999	175.8	0.08	1.0	0.004	74.6	0.976	178.7
1750	0.999	176.0	0.07	1.2	0.004	75.2	0.976	178.4
1800	0.999	175.9	0.07	1.9	0.004	76.6	0.978	178.1
1850	0.999	175.8	0.06	1.9	0.005	78.8	0.978	177.7
1900	0.999	175.7	0.06	3.0	0.005	78.7	0.977	177.3
1950	0.999	175.4	0.06	3.1	0.005	79.7	0.980	177.1
2000	0.999	174.9	0.06	3.4	0.006	79.1	0.981	176.8
2050	0.999	174.6	0.05	3.5	0.006	81.0	0.982	176.6
2100	0.999	174.2	0.05	3.6	0.006	80.3	0.982	176.3
2150	0.999	173.6	0.05	3.2	0.007	80.9	0.986	176.1
2200	0.999	173.0	0.05	3.0	0.007	80.5	0.985	176.0
2250	0.999	172.8	0.04	3.0	0.007	80.7	0.985	175.7
2300	0.999	172.1	0.04	3.0	0.007	80.5	0.984	175.4
2350	0.999	171.6	0.04	3.4	0.008	81.6	0.988	175.2
2400	0.999	171.6	0.04	3.7	0.008	81.2	0.985	175.2
2450	0.999	171.6	0.04	3.8	0.008	80.7	0.984	174.9
2500	0.999	171.4	0.04	4.6	0.009	80.5	0.985	174.6

## S parameter

 $(V_{DS} = 7.5 \text{ V}, I_D = 100 \text{ mA}, Z_o = 50 \Omega)$ 

f (MHz)	S11		S21		S12		S22	
	MAG	ANG (deg.)	MAG	ANG (deg.)	MAG	ANG (deg.)	MAG	ANG (deg.)
100	0.844	-161.0	9.17	82.5	0.020	-3.8	0.702	-165.1
150	0.855	-165.9	5.87	72.1	0.019	-16.1	0.731	-166.4
200	0.867	-168.1	4.19	64.4	0.017	-22.8	0.760	-166.6
250	0.880	-169.6	3.17	57.7	0.017	-29.0	0.789	-166.9
300	0.880	-170.8	2.49	51.8	0.015	-31.9	0.802	-167.7
350	0.906	-172.0	1.96	46.7	0.014	-37.6	0.840	-168.3
400	0.913	-172.7	1.60	42.2	0.012	-40.1	0.862	-169.1
450	0.925	-173.5	1.33	38.4	0.011	-44.6	0.878	-169.8
500	0.932	-174.4	1.12	35.1	0.010	-45.7	0.892	-170.5
550	0.939	-175.0	0.96	31.9	0.009	-49.7	0.903	-171.4
600	0.944	-175.4	0.83	29.3	0.008	-50.1	0.912	-172.1
650	0.944	-176.1	0.72	26.6	0.007	-50.3	0.919	-172.7
700	0.946	-176.9	0.63	24.2	0.007	-50.0	0.928	-173.3
750	0.951	-177.4	0.56	22.0	0.006	-50.8	0.934	-173.8
800	0.952	-178.1	0.49	20.0	0.005	-50.0	0.937	-174.4
850	0.958	-178.9	0.44	18.5	0.004	-50.1	0.941	-174.9
900	0.961	-179.2	0.40	17.3	0.004	-44.7	0.947	-175.5
950	0.967	-179.3	0.36	16.0	0.003	-44.2	0.951	-175.9
1000	0.971	-179.7	0.33	15.0	0.003	-42.4	0.954	-176.5
1050	0.969	-180.0	0.30	13.9	0.002	-35.6	0.957	-177.0
1100	0.972	179.7	0.27	12.7	0.002	-27.0	0.959	-177.5
1150	0.976	179.7	0.25	11.6	0.002	-15.0	0.961	-177.7
1200	0.976	179.5	0.23	11.0	0.002	-6.4	0.963	-178.2
1250	0.978	179.1	0.21	9.7	0.002	10.7	0.963	-178.6
1300	0.976	179.1	0.20	9.0	0.002	21.9	0.965	-178.8
1350	0.979	178.7	0.18	8.0	0.002	37.1	0.966	-179.1
1400	0.980	178.3	0.17	7.0	0.002	45.3	0.966	-179.3
1450	0.982	177.7	0.16	5.9	0.002	53.3	0.967	-179.8
1500	0.983	177.0	0.15	4.9	0.003	61.1	0.967	180.0
1550	0.984	176.4	0.14	4.3	0.003	64.9	0.968	179.7
1600	0.985	175.8	0.13	4.1	0.003	66.4	0.969	179.2
1650	0.999	175.9	0.13	4.2	0.004	67.9	0.969	179.1
1700	0.999	175.6	0.12	3.7	0.004	69.8	0.969	178.7
1750	0.999	175.9	0.12	3.9	0.004	73.2	0.970	178.3
1800	0.999	175.7	0.11	3.8	0.004	72.8	0.972	178.0
1850	0.999	175.7	0.10	4.0	0.005	75.9	0.970	177.7
1900	0.999	175.8	0.10	4.5	0.005	76.8	0.971	177.2
1950	0.999	175.3	0.09	4.5	0.006	76.8	0.973	177.0
2000	0.999	174.9	0.09	4.2	0.006	77.5	0.974	176.8
2050	0.999	174.6	0.08	4.7	0.006	79.9	0.973	176.6
2100	0.999	174.0	0.08	4.2	0.007	77.7	0.975	176.3
2150	0.999	173.4	0.08	3.6	0.007	79.2	0.979	176.0
2200	0.999	172.8	0.07	2.8	0.007	79.7	0.979	176.0
2250	0.999	172.6	0.07	2.6	0.007	79.0	0.979	175.7
2300	0.999	172.0	0.07	2.4	0.008	79.0	0.979	175.4
2350	0.999	171.4	0.07	2.0	0.008	79.9	0.983	175.3
2400	0.999	171.3	0.06	1.9	0.008	80.2	0.978	175.1
2450	0.999	171.3	0.06	1.8	0.008	79.5	0.979	174.8
2500	0.999	171.3	0.06	2.3	0.009	79.2	0.980	174.6

## S parameter

 $(V_{DS} = 7.5 \text{ V}, I_D = 200 \text{ mA}, Z_o = 50 \Omega)$ 

f (MHz)	S11		S21		S12		S22	
	MAG	ANG (deg.)	MAG	ANG (deg.)	MAG	ANG (deg.)	MAG	ANG (deg.)
100	0.879	-164.2	10.01	85.5	0.014	-3.4	0.758	-171.4
150	0.880	-168.9	6.55	77.0	0.014	-10.6	0.773	-172.1
200	0.884	-170.9	4.75	70.5	0.013	-13.8	0.787	-172.0
250	0.893	-172.1	3.69	64.7	0.012	-20.8	0.803	-171.8
300	0.884	-173.3	2.95	59.3	0.012	-23.7	0.805	-172.0
350	0.906	-173.9	2.37	54.9	0.011	-27.5	0.835	-172.1
400	0.913	-174.8	1.97	50.7	0.010	-29.4	0.852	-172.4
450	0.922	-175.3	1.67	46.9	0.009	-33.1	0.866	-172.6
500	0.931	-175.7	1.43	43.5	0.009	-34.6	0.878	-173.0
550	0.932	-176.0	1.24	40.3	0.008	-35.6	0.887	-173.4
600	0.935	-176.4	1.08	37.4	0.007	-37.2	0.897	-173.7
650	0.938	-177.0	0.95	34.6	0.007	-38.0	0.903	-174.1
700	0.939	-177.7	0.84	32.1	0.006	-36.3	0.913	-174.5
750	0.944	-178.2	0.75	29.5	0.005	-37.3	0.919	-175.0
800	0.946	-178.6	0.67	27.7	0.005	-35.8	0.923	-175.4
850	0.953	-179.3	0.61	25.8	0.004	-34.3	0.929	-175.7
900	0.957	-179.7	0.55	24.0	0.004	-28.9	0.934	-176.2
950	0.964	-180.0	0.50	22.6	0.003	-27.9	0.939	-176.6
1000	0.965	-180.0	0.46	21.5	0.003	-22.4	0.943	-176.9
1050	0.969	179.5	0.42	20.0	0.003	-14.2	0.945	-177.4
1100	0.969	179.6	0.38	18.6	0.002	-7.2	0.949	-177.9
1150	0.968	179.3	0.35	17.4	0.002	5.2	0.951	-178.2
1200	0.973	179.3	0.32	16.6	0.002	8.9	0.954	-178.6
1250	0.972	178.7	0.30	15.0	0.002	24.2	0.954	-179.0
1300	0.972	178.8	0.28	14.1	0.002	31.9	0.957	-179.1
1350	0.971	178.7	0.26	13.1	0.002	41.1	0.959	-179.4
1400	0.975	178.1	0.24	11.9	0.003	46.9	0.959	-179.6
1450	0.974	177.7	0.22	10.6	0.003	51.3	0.959	-180.0
1500	0.975	177.0	0.21	9.4	0.003	59.2	0.961	179.7
1550	0.978	176.5	0.20	9.0	0.003	61.8	0.961	179.5
1600	0.984	175.8	0.19	8.4	0.004	63.3	0.962	179.1
1650	0.990	175.8	0.18	8.1	0.004	67.9	0.962	178.9
1700	0.995	175.5	0.17	7.6	0.004	68.4	0.963	178.5
1750	0.998	175.8	0.16	7.4	0.005	71.3	0.964	178.2
1800	0.999	176.0	0.16	7.3	0.005	71.6	0.967	177.8
1850	0.999	175.7	0.15	7.1	0.005	74.7	0.966	177.5
1900	0.999	175.6	0.14	7.3	0.005	74.8	0.965	177.2
1950	0.999	175.3	0.13	7.2	0.006	75.1	0.967	176.9
2000	0.999	174.8	0.13	7.0	0.006	75.7	0.969	176.7
2050	0.999	174.3	0.12	7.0	0.006	78.5	0.969	176.5
2100	0.999	173.8	0.12	6.4	0.007	76.6	0.971	176.2
2150	0.999	173.3	0.11	5.6	0.007	77.1	0.974	176.0
2200	0.999	172.6	0.11	4.9	0.007	77.0	0.975	175.9
2250	0.999	172.2	0.10	4.1	0.008	77.6	0.974	175.6
2300	0.999	171.8	0.10	3.4	0.008	77.3	0.976	175.3
2350	0.999	171.3	0.09	3.0	0.008	78.4	0.980	175.2
2400	0.999	171.4	0.09	3.1	0.008	78.5	0.977	175.1
2450	0.999	171.3	0.09	2.9	0.009	78.4	0.977	174.8
2500	0.999	171.2	0.09	2.9	0.009	78.8	0.977	174.5

## S parameter

 $(V_{DS} = 7.5 \text{ V}, I_D = 300 \text{ mA}, Z_o = 50 \Omega)$ 

f (MHz)	S11		S21		S12		S22	
	MAG	ANG (deg.)	MAG	ANG (deg.)	MAG	ANG (deg.)	MAG	ANG (deg.)
100	0.896	-165.0	10.25	87.2	0.013	3.4	0.785	-173.3
150	0.892	-169.8	6.73	79.1	0.012	-4.6	0.795	-174.1
200	0.895	-171.6	4.94	73.2	0.011	-10.3	0.805	-173.9
250	0.901	-173.1	3.85	67.9	0.011	-16.0	0.816	-173.7
300	0.891	-174.1	3.11	62.9	0.011	-18.7	0.814	-173.8
350	0.912	-175.0	2.51	58.5	0.010	-22.0	0.840	-173.7
400	0.918	-175.1	2.11	54.8	0.009	-23.4	0.855	-173.9
450	0.924	-175.8	1.80	50.9	0.009	-27.0	0.865	-174.0
500	0.933	-176.3	1.56	47.5	0.008	-28.2	0.875	-174.2
550	0.931	-176.7	1.35	44.3	0.007	-29.4	0.885	-174.5
600	0.932	-176.9	1.19	41.5	0.007	-30.5	0.893	-174.7
650	0.937	-177.5	1.05	38.8	0.006	-29.9	0.899	-175.0
700	0.936	-178.0	0.93	35.8	0.006	-27.9	0.907	-175.3
750	0.938	-178.4	0.84	33.6	0.005	-28.5	0.914	-175.7
800	0.945	-179.0	0.75	31.4	0.005	-26.9	0.918	-175.9
850	0.948	-179.7	0.69	29.3	0.004	-26.6	0.924	-176.4
900	0.953	180.0	0.63	27.5	0.004	-20.4	0.929	-176.6
950	0.961	179.8	0.57	26.0	0.003	-16.5	0.935	-177.0
1000	0.963	179.9	0.52	25.0	0.003	-14.1	0.938	-177.4
1050	0.966	179.6	0.48	23.1	0.003	-5.8	0.940	-177.8
1100	0.966	179.3	0.44	21.9	0.003	3.2	0.944	-178.2
1150	0.966	179.3	0.41	20.8	0.003	11.0	0.948	-178.4
1200	0.967	179.2	0.37	19.6	0.002	15.9	0.949	-178.8
1250	0.969	179.0	0.34	18.3	0.003	26.3	0.950	-179.2
1300	0.970	178.7	0.32	17.1	0.003	33.7	0.953	-179.3
1350	0.972	178.4	0.30	15.8	0.003	44.4	0.954	-179.6
1400	0.976	178.2	0.28	14.5	0.003	49.3	0.955	-179.8
1450	0.974	177.4	0.26	13.4	0.003	52.7	0.956	179.9
1500	0.974	176.8	0.24	12.1	0.004	59.3	0.956	179.6
1550	0.980	176.3	0.23	11.5	0.004	62.8	0.959	179.4
1600	0.985	175.8	0.22	10.8	0.004	63.8	0.959	178.9
1650	0.997	175.7	0.21	10.3	0.004	66.1	0.959	178.8
1700	0.999	175.7	0.20	10.0	0.005	68.4	0.960	178.4
1750	0.999	175.7	0.19	9.7	0.005	69.6	0.961	178.1
1800	0.999	175.6	0.18	9.3	0.005	69.4	0.964	177.7
1850	0.999	175.7	0.17	9.0	0.005	70.8	0.962	177.4
1900	0.999	175.5	0.16	9.2	0.006	72.8	0.963	177.1
1950	0.999	175.2	0.16	9.0	0.006	74.1	0.965	176.8
2000	0.999	174.7	0.15	8.8	0.006	74.9	0.966	176.6
2050	0.999	174.3	0.14	8.6	0.007	76.4	0.967	176.4
2100	0.999	173.7	0.13	8.0	0.007	75.7	0.969	176.1
2150	0.999	173.1	0.13	7.2	0.007	77.2	0.972	175.9
2200	0.999	172.5	0.12	6.4	0.007	77.1	0.972	175.8
2250	0.999	172.1	0.12	5.5	0.008	77.9	0.972	175.5
2300	0.999	171.6	0.11	5.0	0.008	76.4	0.973	175.3
2350	0.999	171.2	0.11	4.1	0.008	78.3	0.977	175.1
2400	0.999	171.1	0.11	4.1	0.009	78.1	0.974	175.0
2450	0.999	171.1	0.10	3.6	0.009	78.3	0.974	174.7
2500	0.999	171.0	0.10	3.7	0.009	78.3	0.974	174.4

## S parameter

(V<sub>DS</sub> = 7.5 V, I<sub>D</sub> = 400 mA, Z<sub>o</sub> = 50 Ω)

f (MHz)	S11		S21		S12		S22	
	MAG	ANG (deg.)	MAG	ANG (deg.)	MAG	ANG (deg.)	MAG	ANG (deg.)
100	0.903	-165.5	10.28	88.0	0.013	4.2	0.799	-174.4
150	0.903	-170.2	6.78	80.2	0.011	-6.6	0.808	-175.1
200	0.901	-172.3	4.99	74.6	0.010	-9.4	0.816	-174.9
250	0.907	-173.5	3.91	69.6	0.010	-13.8	0.826	-174.7
300	0.895	-174.7	3.17	64.6	0.010	-15.9	0.821	-174.8
350	0.916	-175.4	2.58	60.6	0.009	-20.6	0.847	-174.9
400	0.922	-175.8	2.17	56.7	0.008	-20.5	0.859	-174.7
450	0.927	-176.2	1.86	53.1	0.008	-23.5	0.868	-174.8
500	0.932	-176.7	1.62	49.6	0.007	-24.4	0.876	-175.0
550	0.936	-177.0	1.42	46.7	0.007	-25.3	0.884	-175.1
600	0.937	-177.3	1.25	43.7	0.006	-26.5	0.892	-175.3
650	0.938	-177.7	1.10	40.9	0.006	-26.1	0.898	-175.5
700	0.939	-178.4	0.98	38.3	0.006	-25.0	0.907	-175.8
750	0.943	-178.8	0.88	35.6	0.005	-23.6	0.912	-176.0
800	0.946	-179.3	0.80	33.5	0.004	-19.9	0.915	-176.3
850	0.948	-179.9	0.73	31.5	0.004	-18.5	0.922	-176.7
900	0.956	179.7	0.67	29.8	0.004	-15.7	0.927	-177.0
950	0.960	179.6	0.61	28.1	0.003	-12.0	0.933	-177.3
1000	0.964	179.7	0.56	26.9	0.003	-7.7	0.937	-177.7
1050	0.963	179.3	0.51	25.5	0.003	-0.5	0.939	-178.0
1100	0.966	179.3	0.47	23.8	0.003	7.8	0.942	-178.4
1150	0.966	179.3	0.43	22.6	0.003	15.4	0.945	-178.6
1200	0.969	179.1	0.40	21.4	0.003	22.3	0.947	-179.0
1250	0.970	178.7	0.37	20.1	0.003	31.2	0.948	-179.4
1300	0.972	178.5	0.34	18.8	0.003	39.9	0.951	-179.5
1350	0.970	178.4	0.32	17.5	0.003	44.3	0.953	-179.7
1400	0.973	177.9	0.30	16.1	0.003	47.7	0.954	-179.9
1450	0.975	177.4	0.28	14.7	0.003	51.8	0.954	179.7
1500	0.974	176.6	0.26	13.6	0.004	60.0	0.955	179.4
1550	0.980	176.3	0.25	12.9	0.004	60.3	0.957	179.2
1600	0.983	175.7	0.24	12.0	0.004	62.3	0.958	178.8
1650	0.990	175.5	0.23	11.8	0.004	65.9	0.958	178.6
1700	0.996	175.6	0.21	11.2	0.005	66.9	0.959	178.3
1750	0.999	175.6	0.20	10.9	0.005	68.5	0.959	178.0
1800	0.999	175.6	0.20	10.4	0.005	69.5	0.961	177.7
1850	0.999	175.5	0.19	10.3	0.005	72.5	0.960	177.3
1900	0.999	175.4	0.18	10.4	0.006	72.6	0.962	177.0
1950	0.999	175.1	0.17	10.1	0.006	74.0	0.963	176.7
2000	0.999	174.6	0.16	10.0	0.006	75.7	0.965	176.5
2050	0.999	174.3	0.15	9.5	0.007	76.3	0.966	176.3
2100	0.999	173.6	0.14	9.0	0.007	74.3	0.968	176.0
2150	0.999	172.9	0.14	8.0	0.007	76.1	0.970	175.8
2200	0.999	172.2	0.13	7.1	0.008	77.1	0.972	175.7
2250	0.999	171.9	0.13	6.4	0.008	77.6	0.971	175.4
2300	0.999	171.6	0.12	5.8	0.008	77.0	0.972	175.2
2350	0.999	171.2	0.12	5.0	0.008	78.5	0.975	175.0
2400	0.999	170.9	0.11	4.5	0.009	78.2	0.973	174.9
2450	0.999	171.0	0.11	4.4	0.009	77.2	0.973	174.6
2500	0.999	170.8	0.11	4.4	0.009	77.7	0.974	174.4



### Package Dimensions

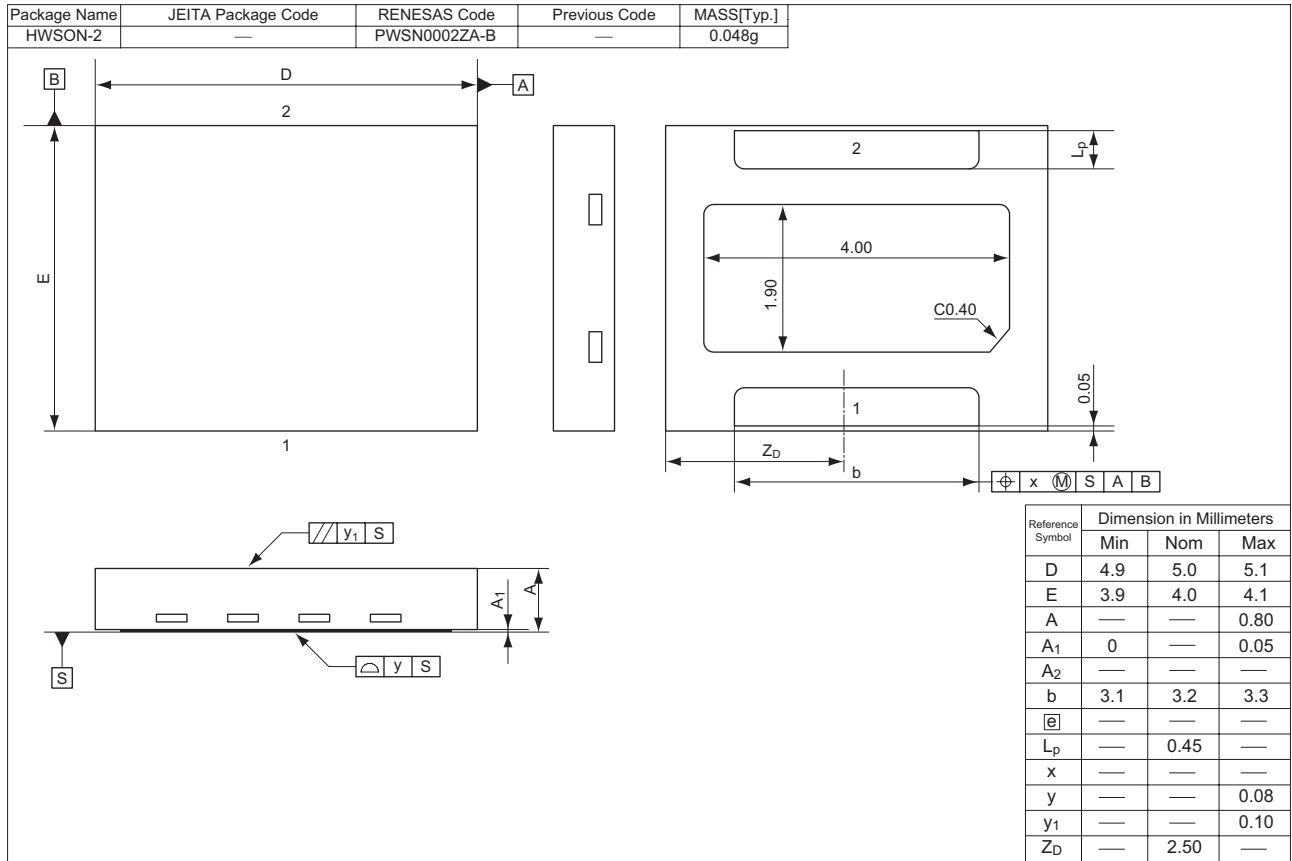

### Ordering Information

Part Name	Quantity	Shipping Container
RQA0002DNSTB-E	2000 pcs.	φ178 mm Reel, 12 mm Emboss Taping

Notes:

1. This document is provided for reference purposes only so that Renesas customers may select the appropriate Renesas products for their use. Renesas neither makes warranties or representations with respect to the accuracy or completeness of the information contained in this document nor grants any license to any intellectual property rights or any other rights of Renesas or any third party with respect to the information in this document.
2. Renesas shall have no liability for damages or infringement of any intellectual property or other rights arising out of the use of any information in this document, including, but not limited to, product data, diagrams, charts, programs, algorithms, and application circuit examples.
3. You should not use the products or the technology described in this document for the purpose of military applications such as the development of weapons of mass destruction or for the purpose of any other military use. When exporting the products or technology described herein, you should follow the applicable export control laws and regulations, and procedures required by such laws and regulations.
4. All information included in this document such as product data, diagrams, charts, programs, algorithms, and application circuit examples, is current as of the date this document is issued. Such information, however, is subject to change without any prior notice. Before purchasing or using any Renesas products listed in this document, please confirm the latest product information with a Renesas sales office. Also, please pay regular and careful attention to additional and different information to be disclosed by Renesas such as that disclosed through our website. (<http://www.renesas.com>)
5. Renesas has used reasonable care in compiling the information included in this document, but Renesas assumes no liability whatsoever for any damages incurred as a result of errors or omissions in the information included in this document.
6. When using or otherwise relying on the information in this document, you should evaluate the information in light of the total system before deciding about the applicability of such information to the intended application. Renesas makes no representations, warranties or guarantees regarding the suitability of its products for any particular application and specifically disclaims any liability arising out of the application and use of the information in this document or Renesas products.
7. With the exception of products specified by Renesas as suitable for automobile applications, Renesas products are not designed, manufactured or tested for applications or otherwise in systems the failure or malfunction of which may cause a direct threat to human life or create a risk of human injury or which require especially high quality and reliability such as safety systems, or equipment or systems for transportation and traffic, healthcare, combustion control, aerospace and aeronautics, nuclear power, or undersea communication transmission. If you are considering the use of our products for such purposes, please contact a Renesas sales office beforehand. Renesas shall have no liability for damages arising out of the uses set forth above.
8. Notwithstanding the preceding paragraph, you should not use Renesas products for the purposes listed below:
  - (1) artificial life support devices or systems
  - (2) surgical implantations
  - (3) healthcare intervention (e.g., excision, administration of medication, etc.)
  - (4) any other purposes that pose a direct threat to human lifeRenesas shall have no liability for damages arising out of the uses set forth in the above and purchasers who elect to use Renesas products in any of the foregoing applications shall indemnify and hold harmless Renesas Technology Corp., its affiliated companies and their officers, directors, and employees against any and all damages arising out of such applications.
9. You should use the products described herein within the range specified by Renesas, especially with respect to the maximum rating, operating supply voltage range, movement power voltage range, heat radiation characteristics, installation and other product characteristics. Renesas shall have no liability for malfunctions or damages arising out of the use of Renesas products beyond such specified ranges.
10. Although Renesas endeavors to improve the quality and reliability of its products, IC products have specific characteristics such as the occurrence of failure at a certain rate and malfunctions under certain use conditions. Please be sure to implement safety measures to guard against the possibility of physical injury, and injury or damage caused by fire in the event of the failure of a Renesas product, such as safety design for hardware and software including but not limited to redundancy, fire control and malfunction prevention, appropriate treatment for aging degradation or any other applicable measures. Among others, since the evaluation of microcomputer software alone is very difficult, please evaluate the safety of the final products or system manufactured by you.
11. In case Renesas products listed in this document are detached from the products to which the Renesas products are attached or affixed, the risk of accident such as swallowing by infants and small children is very high. You should implement safety measures so that Renesas products may not be easily detached from your products. Renesas shall have no liability for damages arising out of such detachment.
12. This document may not be reproduced or duplicated, in any form, in whole or in part, without prior written approval from Renesas.
13. Please contact a Renesas sales office if you have any questions regarding the information contained in this document, Renesas semiconductor products, or if you have any other inquiries.



**RENESAS SALES OFFICES**

<http://www.renesas.com>

Refer to "<http://www.renesas.com/en/network>" for the latest and detailed information.

**Renesas Technology America, Inc.**  
450 Holger Way, San Jose, CA 95134-1368, U.S.A  
Tel: <1> (408) 382-7500, Fax: <1> (408) 382-7501

**Renesas Technology Europe Limited**  
Dukes Meadow, Millboard Road, Bourne End, Buckinghamshire, SL8 5FH, U.K.  
Tel: <44> (1628) 585-100, Fax: <44> (1628) 585-900

**Renesas Technology (Shanghai) Co., Ltd.**  
Unit 204, 205, AZIACenter, No.1233 Lujiazui Ring Rd, Pudong District, Shanghai, China 200120  
Tel: <86> (21) 5877-1818, Fax: <86> (21) 6887-7898

**Renesas Technology Hong Kong Ltd.**  
7th Floor, North Tower, World Finance Centre, Harbour City, 1 Canton Road, Tsimshatsui, Kowloon, Hong Kong  
Tel: <852> 2265-6688, Fax: <852> 2730-6071

**Renesas Technology Taiwan Co., Ltd.**  
10th Floor, No.99, Fushing North Road, Taipei, Taiwan  
Tel: <886> (2) 2715-2888, Fax: <886> (2) 2713-2999

**Renesas Technology Singapore Pte. Ltd.**  
1 Harbour Front Avenue, #06-10, Keppel Bay Tower, Singapore 098632  
Tel: <65> 6213-0200, Fax: <65> 6278-8001

**Renesas Technology Korea Co., Ltd.**  
Kukje Center Bldg. 18th Fl., 191, 2-ka, Hangang-ro, Yongsan-ku, Seoul 140-702, Korea  
Tel: <82> (2) 796-3115, Fax: <82> (2) 796-2145

**Renesas Technology Malaysia Sdn. Bhd**  
Unit 906, Block B, Menara Amcorp, Amcorp Trade Centre, No.18, Jalan Persiaran Barat, 46050 Petaling Jaya, Selangor Darul Ehsan, Malaysia  
Tel: <603> 7955-9390, Fax: <603> 7955-9510