

### Hermetic, 50 Mil Pitch, Leadless Chip Resistor Networks

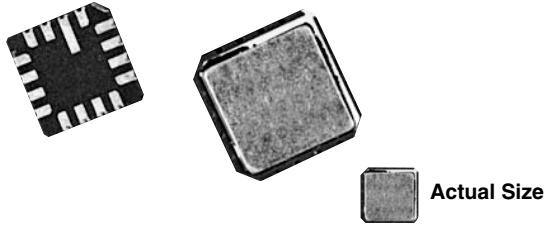

Vishay Thin Film offers a wide resistance range in 16, 20, and 24 terminal hermetic leadless chip carriers. The standard circuits in the ohmic ranges listed below will utilize the outstanding wraparound terminations developed for chip resistors. Should one of the standards not fit your application, consult the factory for a custom circuit.

#### FEATURES

- Lead (Pb)-free available
- High purity alumina substrate for high power dissipation
- Leach resistant terminations with nickel barrier
- 16, 20, 24 terminal gold plated wraparound true hermetic packaging
- Military/Aerospace
- Hermetically sealed
- Isolated/Bussed circuits
- Ideal for military/aerospace applications



**RoHS\***  
COMPLIANT

#### TYPICAL PERFORMANCE

	ABS	TRACKING
TCR	25	5
	ABS	RATIO
TOL	0.1	NA

Resistance range: Noted on schematics

#### SCHEMATIC

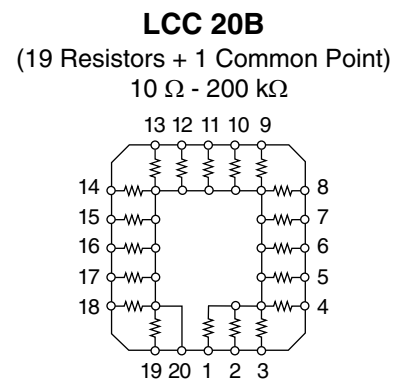
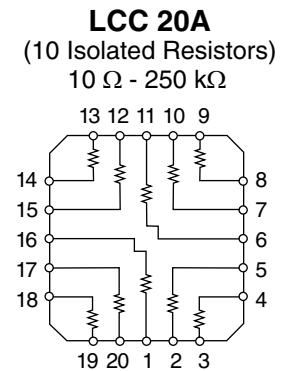
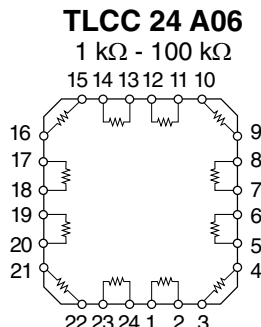
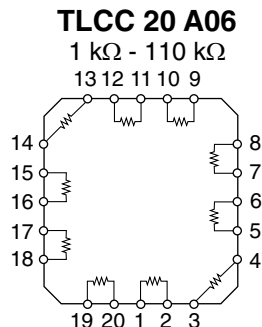
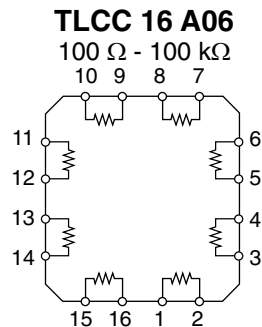
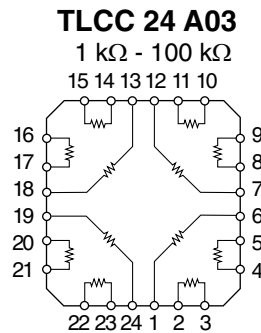
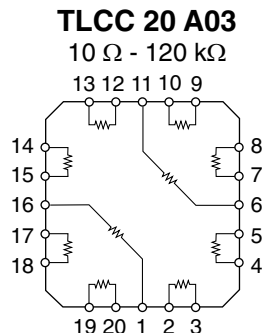
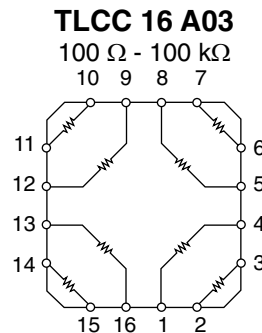
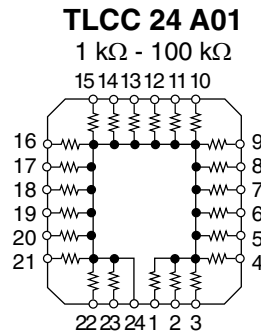
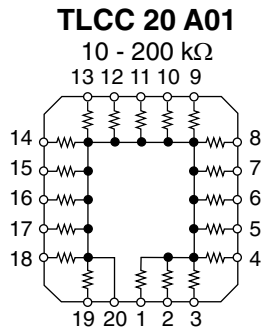
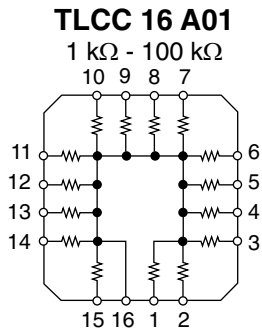

\* Pb containing terminations are not RoHS compliant, exemptions may apply

# LCC, TLCC



Vishay Thin Film Hermetic, 50 Mil Pitch, Leadless Chip Resistor Networks

STANDARD ELECTRICAL SPECIFICATIONS			
TEST	SPECIFICATIONS		CONDITIONS
Material	Passivated nichrome		
TCR:	Tracking	$\pm 5$ ppm/ $^{\circ}$ C	- 55 $^{\circ}$ C to + 125 $^{\circ}$ C
	Absolute	$\pm 25$ ppm/ $^{\circ}$ C, $\pm 50$ ppm/ $^{\circ}$ C, $\pm 100$ ppm/ $^{\circ}$ C and $\pm 300$ ppm/ $^{\circ}$ C	- 55 $^{\circ}$ C to + 125 $^{\circ}$ C
Tolerance:	Ratio	N/a	
	Absolute	$\pm 1.0$ %, $\pm 0.5$ %, $\pm 0.25$ %, $\pm 0.1$ %	+ 25 $^{\circ}$ C
Power Rating:	Resistor	50 mW max. (common circuits); 100 mW max. (isolated circuits)	Max. at + 70 $^{\circ}$ C
	Package	500 mW	Max. at + 70 $^{\circ}$ C
Stability:	$\Delta R$ Absolute	0.1 %	2000 h at + 70 $^{\circ}$ C
	$\Delta R$ Ratio	0.03 %	2000 h at + 70 $^{\circ}$ C
Voltage Coefficient	< 5 ppm/V typical		
Working Voltage	100 V		
Operating Temperature Range	- 55 $^{\circ}$ C to + 125 $^{\circ}$ C		
Storage Temperature Range	- 55 $^{\circ}$ C to + 150 $^{\circ}$ C		
Noise	< - 30 dB		
Thermal EMF	0.008 $\mu$ V/ $^{\circ}$ C		
Shelf Life Stability:	Absolute	100 ppm	1 year at + 25 $^{\circ}$ C
	Ratio	20 ppm	1 year at + 25 $^{\circ}$ C

**Note**

- Tantalum nitride film is custom, consult factory

**DIMENSIONS** in inches and millimeters

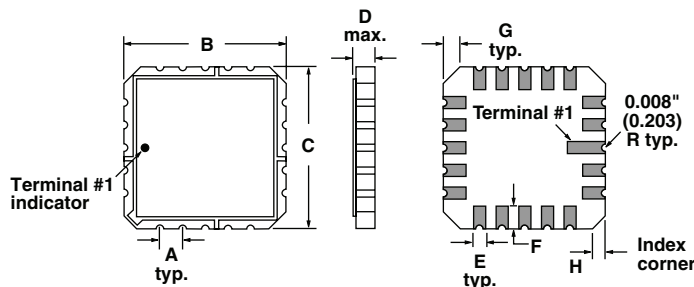

	A	B	C	D	E	F	G	H
16 Pin	0.050"	0.300"	0.300"	0.077"	0.025"	0.050"	0.040"	0.020"
(mm)	(1.27)	(7.62)	(7.62)	(1.96)	(0.635)	(1.27)	(1.02)	(0.508)
20 Pin	0.050"	0.350"	0.350"	0.077"	0.025"	0.050"	0.040"	0.020"
(mm)	(1.27)	(8.89)	(8.89)	(1.96)	(0.635)	(1.27)	(1.02)	(0.508)
24 Pin	0.050"	0.400"	0.400"	0.077"	0.025"	0.050"	0.040"	0.020"
(mm)	(1.27)	(10.16)	(10.16)	(1.96)	(0.635)	(1.27)	(1.02)	(0.508)



MECHANICAL SPECIFICATIONS	
Resistive Element	Passivated nichrome
Substrate Material	Alumina
Body	Ceramic
Terminals	Gold over nickel
Marking Resistance to Solvents	Per MIL-PRF-83401
Lead (Pb)-free Option	96.5 % Sn, 3.0 % Ag, 0.5 % Cu
Lead (Pb)-free Finish	Hot solder dip

GLOBAL PART NUMBER INFORMATION																		
New Global Part Numbering: TLCC20AE1002BUF (preferred part number format)																		
	T	L	C	C	2	0		A		E	1	0	0	2	B	U	F	
	T	L	C	C	T	1	6	A	0	1	K	1	0	0	3	K	U	F
GLOBAL MODEL (4 or 5 digits)	TERMINAL COUNT (1)	SCHEMATICS (4 or 5 digits)		TCR CHARACTERISTICS		RESISTANCE		TOLERANCE		PACKAGING								
LCC (Tin lead)	20	A = Isolated resistors		E = 25 ppm/°C H = 50 ppm/°C K = 100 ppm/°C M = 300 ppm/°C		First 3 digits are significant figures and the last digit specifies the number of zeroes to follow. Example: 10R0 = 10 Ω 12R5 = 12.5 Ω 1000 = 100 Ω 1001 = 1000 Ω		B = 0.1 % D = 0.5 % F = 1 % G = 2 % J = 5 % K = 10 % S = Special		TAPE AND REEL T0 = 100 min. 100 mult T1 = 1000 min. 1000 mult T3 = 300 min. 300 mult T5 = 500 min. 500 mult TF = Full reel 2000 TS = 100 min. 1 mult  UF = TUBED								
LCCT (Tin lead)	20	B = Resistor to common bus																
TLCC (Lead (Pb)-free)	16 20 24	A01 = Resistor to common bus																
TLCCT (Lead (Pb)-free (e1))	16 20 24	A03 = Isolated parallel resistor																
		A06 = Isolated adjacent resistor																
Historical Part Number example: LC20BK1003J (will continue to be accepted)																		
	LC		20		B		K		1003		J							
	SERIES		PINS		SCHEMATIC		TCR CHARACTERISTIC		RESISTANCE		TOLERANCE							

**Note**

(1) LCC or LCCT only available in 20 pin size



## Disclaimer

All product specifications and data are subject to change without notice.

Vishay Intertechnology, Inc., its affiliates, agents, and employees, and all persons acting on its or their behalf (collectively, "Vishay"), disclaim any and all liability for any errors, inaccuracies or incompleteness contained herein or in any other disclosure relating to any product.

Vishay disclaims any and all liability arising out of the use or application of any product described herein or of any information provided herein to the maximum extent permitted by law. The product specifications do not expand or otherwise modify Vishay's terms and conditions of purchase, including but not limited to the warranty expressed therein, which apply to these products.

No license, express or implied, by estoppel or otherwise, to any intellectual property rights is granted by this document or by any conduct of Vishay.

The products shown herein are not designed for use in medical, life-saving, or life-sustaining applications unless otherwise expressly indicated. Customers using or selling Vishay products not expressly indicated for use in such applications do so entirely at their own risk and agree to fully indemnify Vishay for any damages arising or resulting from such use or sale. Please contact authorized Vishay personnel to obtain written terms and conditions regarding products designed for such applications.

Product names and markings noted herein may be trademarks of their respective owners.