



FGA25N120FTD

1200V, 25A Field Stop Trench IGBT

Features

- Field stop trench technology
- High speed switching
- Low saturation voltage: $V_{CE(sat)} = 1.6V @ I_C = 25A$
- High input impedance
- RoHS compliant

Applications

- Induction heating and Microwave oven
- Soft switching applications



General Description

Using advanced field stop trench technology, Fairchild's 1200V trench IGBTs offer superior conduction and switching performances, and easy parallel operation with exceptional avalanche ruggedness. This device is designed for soft switching applications.

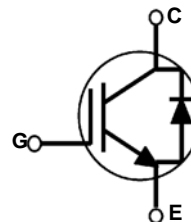
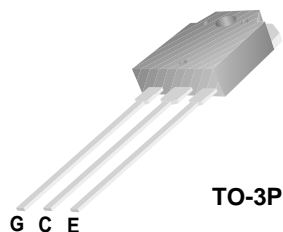

Absolute Maximum Ratings

| Symbol | Description | Ratings | Units |
|--------------|---|-------------|------------|
| V_{CES} | Collector to Emitter Voltage | 1200 | V |
| V_{GES} | Gate to Emitter Voltage | ± 25 | V |
| I_C | Collector Current @ $T_C = 25^\circ C$ | 50 | A |
| | Collector Current @ $T_C = 100^\circ C$ | 25 | A |
| $I_{CM} (1)$ | Pulsed Collector Current | 75 | A |
| I_C | Diode continuous Forward current @ $T_C = 100^\circ C$ | 25 | A |
| P_D | Maximum Power Dissipation @ $T_C = 25^\circ C$ | 313 | W |
| | Maximum Power Dissipation @ $T_C = 100^\circ C$ | 125 | W |
| T_J | Operating Junction Temperature | -55 to +150 | $^\circ C$ |
| T_{stg} | Storage Temperature Range | -55 to +150 | $^\circ C$ |
| T_L | Maximum Lead Temp. for soldering Purposes, 1/8" from case for 5 seconds | 300 | $^\circ C$ |

Notes:

1: Repetitive: Pulse width limited by max. junction temperature

Thermal Characteristics

| Symbol | Parameter | Typ. | Max. | Units |
|------------------------|---|------|------|--------------|
| $R_{\theta JC}(IGBT)$ | Thermal Resistance, Junction to Case | - | 0.4 | $^\circ C/W$ |
| $R_{\theta JC}(Diode)$ | Thermal Resistance, Junction to Case | - | 1.42 | $^\circ C/W$ |
| $R_{\theta JA}$ | Thermal Resistance, Junction to Ambient | - | 40 | $^\circ C/W$ |

Package Marking and Ordering Information

| Device Marking | Device | Package | Packaging Type | Qty per Tube | Max Qty per Box |
|----------------|----------------|---------|----------------|--------------|-----------------|
| FGA25N120FTD | FGA25N120FTDTU | TO-3PN | - | - | 30 |

Electrical Characteristics of the IGBT T_C = 25°C unless otherwise noted

| Symbol | Parameter | Test Conditions | Min. | Typ. | Max. | Units |
|----------------------------------|---|---|------|------|------|-------|
| Off Characteristics | | | | | | |
| BV _{CES} | Collector to Emitter Breakdown Voltage | V _{GE} = 0V, I _C = 1mA | 1200 | - | - | V |
| I _{CES} | Collector Cut-Off Current | V _{CE} = V _{CES} , V _{GE} = 0V | - | - | 1 | mA |
| I _{GES} | G-E Leakage Current | V _{GE} = V _{GES} , V _{CE} = 0V | - | - | ±250 | nA |
| On Characteristics | | | | | | |
| V _{GE(th)} | G-E Threshold Voltage | I _C = 25mA, V _{CE} = V _{GE} | 3.5 | 6 | 7.5 | V |
| V _{CE(sat)} | Collector to Emitter Saturation Voltage | I _C = 25A, V _{GE} = 15V | - | 1.6 | 2 | V |
| | | I _C = 25A, V _{GE} = 15V, T _C = 125°C | - | 1.88 | - | V |
| Dynamic Characteristics | | | | | | |
| C _{ies} | Input Capacitance | V _{CE} = 30V, V _{GE} = 0V, f = 1MHz | - | 3830 | - | pF |
| C _{oes} | Output Capacitance | | - | 130 | - | pF |
| C _{res} | Reverse Transfer Capacitance | | - | 86 | - | pF |
| Switching Characteristics | | | | | | |
| t _{d(on)} | Turn-On Delay Time | V _{CC} = 600V, I _C = 25A, R _G = 15Ω, V _{GE} = 15V, Inductive Load, T _C = 25°C | - | 48 | - | ns |
| t _r | Rise Time | | - | 96 | - | ns |
| t _{d(off)} | Turn-Off Delay Time | | - | 210 | - | ns |
| t _f | Fall Time | | - | 215 | - | ns |
| E _{on} | Turn-On Switching Loss | | - | 0.34 | - | mJ |
| E _{off} | Turn-Off Switching Loss | | - | 0.90 | 1.20 | mJ |
| E _{ts} | Total Switching Loss | - | 1.24 | - | mJ | |
| t _{d(on)} | Turn-On Delay Time | V _{CC} = 600V, I _C = 25A, R _G = 15Ω, V _{GE} = 15V, Inductive Load, T _C = 125°C | - | 44 | - | ns |
| t _r | Rise Time | | - | 113 | - | ns |
| t _{d(off)} | Turn-Off Delay Time | | - | 232 | - | ns |
| t _f | Fall Time | | - | 390 | - | ns |
| E _{on} | Turn-On Switching Loss | | - | 0.38 | - | mJ |
| E _{off} | Turn-Off Switching Loss | | - | 1.39 | - | mJ |
| E _{ts} | Total Switching Loss | - | 1.77 | - | mJ | |
| Q _g | Total Gate Charge | V _{CE} = 600V, I _C = 25A, V _{GE} = 15V | - | 160 | - | nC |
| Q _{ge} | Gate to Emitter Charge | | - | 30 | - | nC |
| Q _{gc} | Gate to Collector Charge | | - | 78 | - | nC |

Electrical Characteristics of the Diode $T_C = 25^\circ\text{C}$ unless otherwise noted

| Symbol | Parameter | Test Conditions | Min. | Typ. | Max | Units | |
|----------|-------------------------------|---|---------------------------|------|------|-------|---------------|
| V_{FM} | Diode Forward Voltage | $I_F = 25\text{A}$ | $T_C = 25^\circ\text{C}$ | - | 1.4 | 1.8 | V |
| | | | $T_C = 125^\circ\text{C}$ | - | 1.42 | - | |
| t_{rr} | Diode Reverse Recovery Time | | $T_C = 25^\circ\text{C}$ | - | 770 | - | ns |
| | | | $T_C = 125^\circ\text{C}$ | - | 895 | - | |
| I_{rr} | Diode Reverse Recovery Time | $I_{ES} = 25\text{A}, dI_{ES}/dt = 200\text{A}/\mu\text{s}$ | $T_C = 25^\circ\text{C}$ | - | 48 | - | A |
| | | | $T_C = 125^\circ\text{C}$ | - | 50 | - | |
| Q_{rr} | Diode Reverse Recovery Charge | | $T_C = 25^\circ\text{C}$ | - | 18 | - | μC |
| | | | $T_C = 125^\circ\text{C}$ | - | 23 | - | |

Typical Performance Characteristics

Figure 1. Typical Output Characteristics

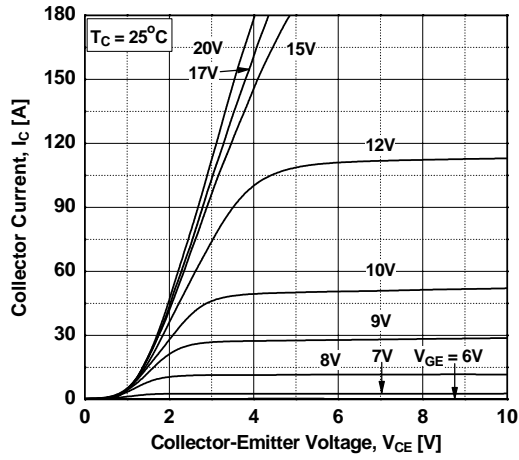

Figure 2. Typical Output Characteristics

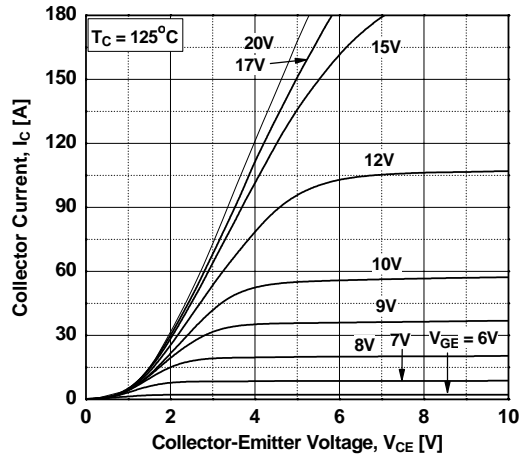

Figure 3. Typical Saturation Voltage Characteristics

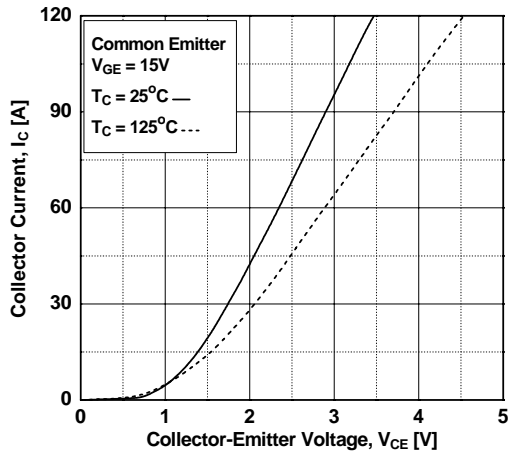

Figure 4. Transfer Characteristics

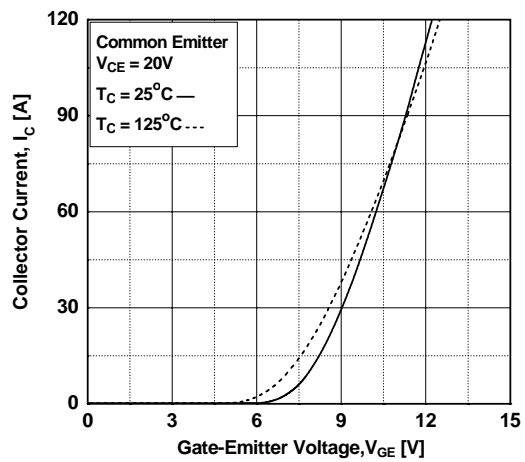

Figure 5. Saturation Voltage vs. Case Temperature at Variant Current Level

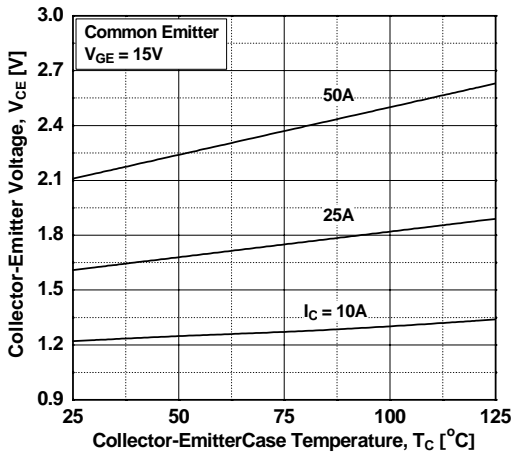
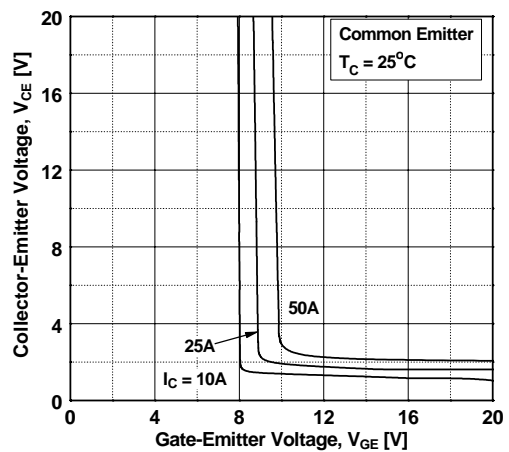

Figure 6. Saturation Voltage vs. Vge



Typical Performance Characteristics

Figure 7. Saturation Voltage vs. V_{GE}

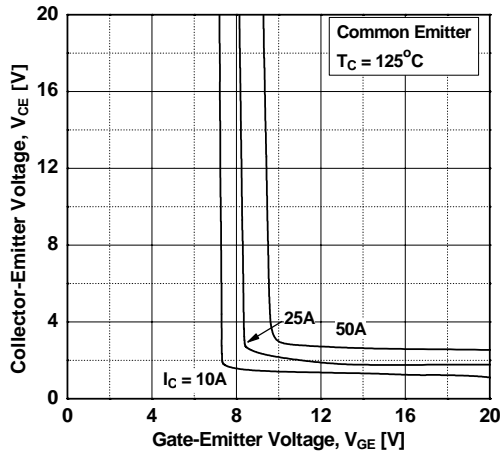

Figure 8. Capacitance Characteristics

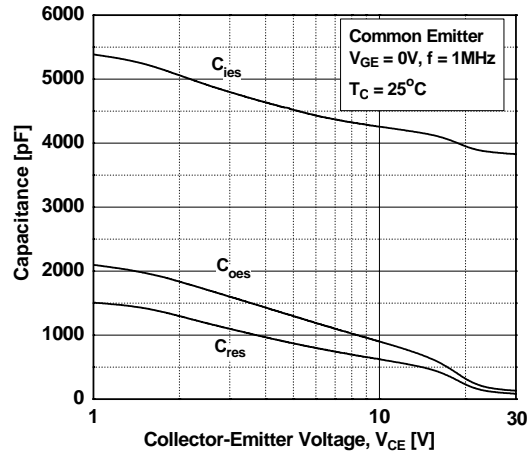

Figure 9. Gate charge Characteristics

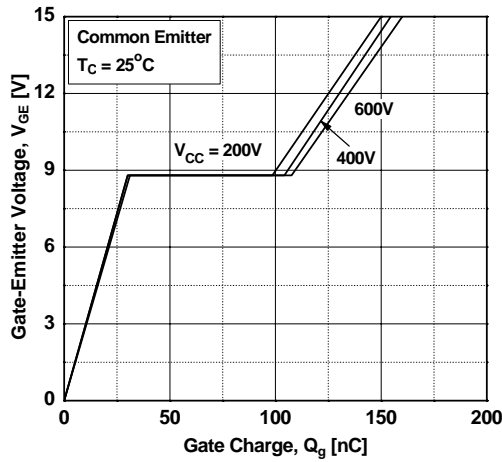

Figure 10. SOA Characteristics

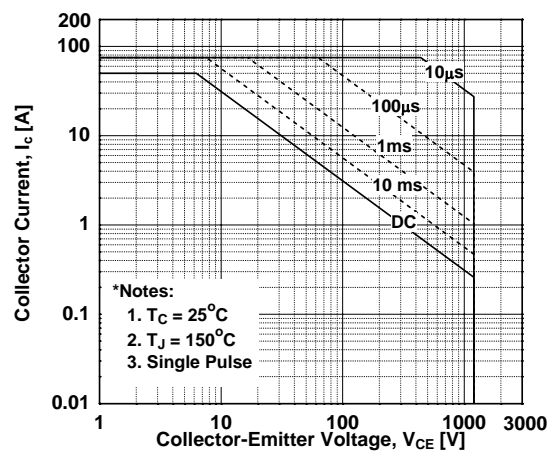

Figure 11. Turn-on Characteristics vs. Gate Resistance

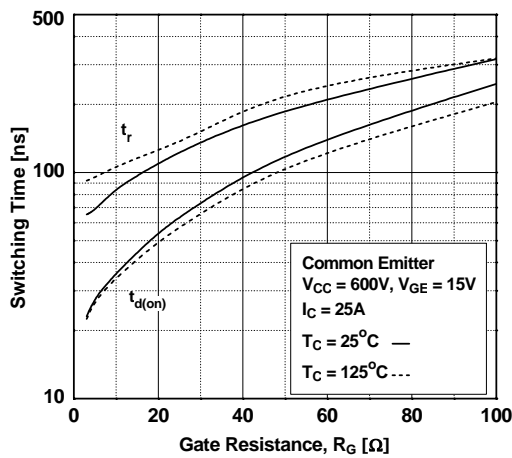
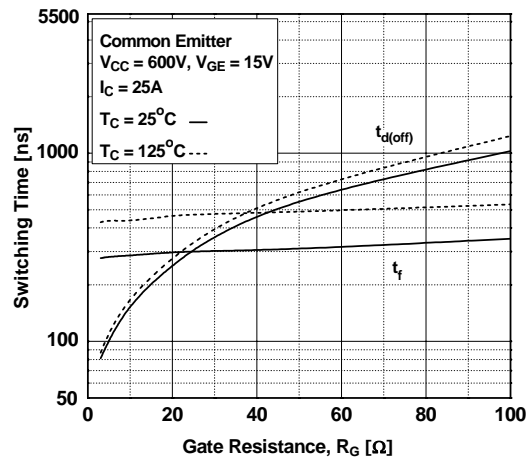

Figure 12. Turn-off Characteristics vs. Gate Resistance



Typical Performance Characteristics

Figure 13. Turn-on Characteristics vs. Collector Current

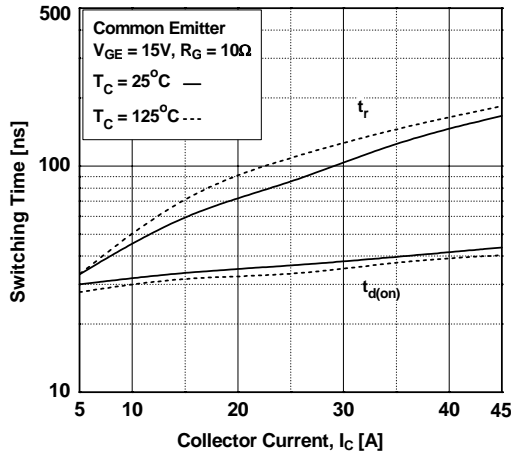

Figure 14. Turn-off Characteristics vs. Collector Current

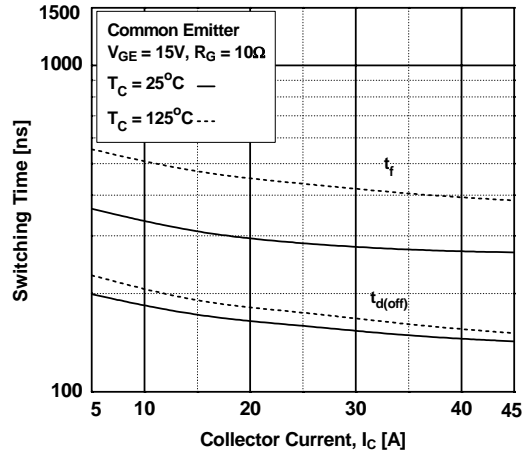

Figure 15. Switching Loss vs. Gate Resistance

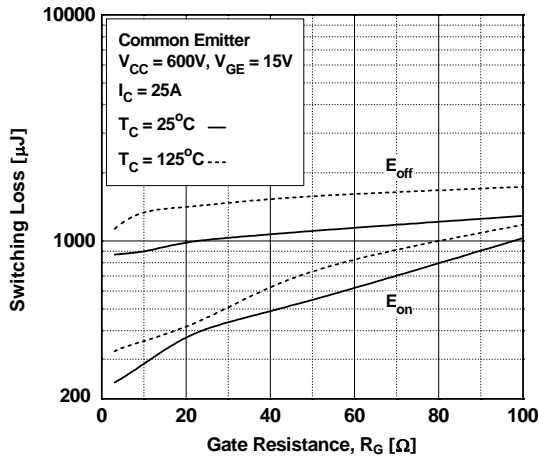

Figure 16. Switching Loss vs. Collector Current

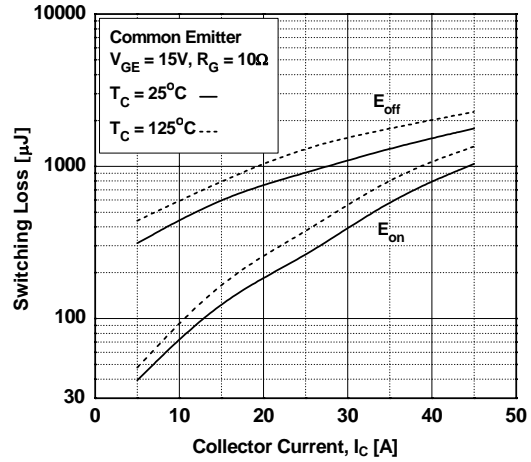

Figure 17. Turn off Switching SOA Characteristics

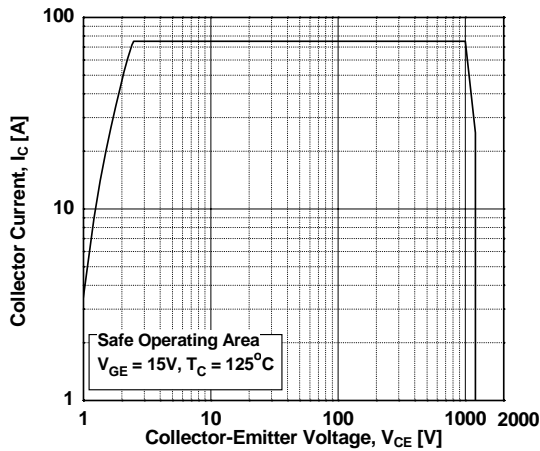
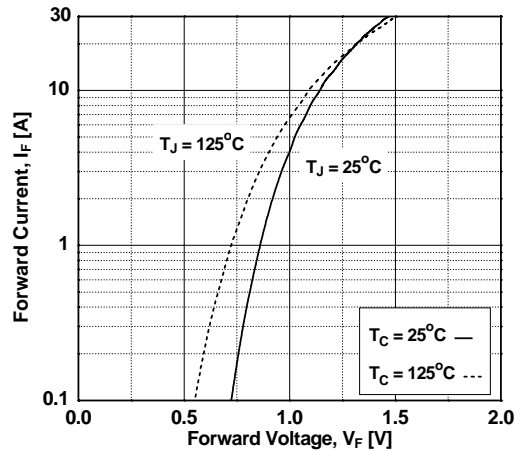

Figure 18. Forward Characteristics



Typical Performance Characteristics

Figure 19. Reverse Recovery Current

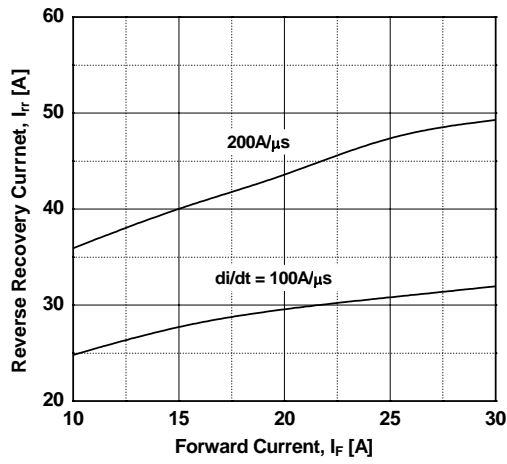

Figure 20. Stored Charge

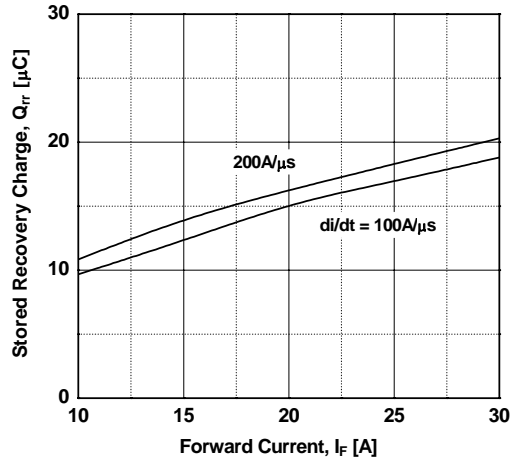

Figure 21. Reverse Recovery Time

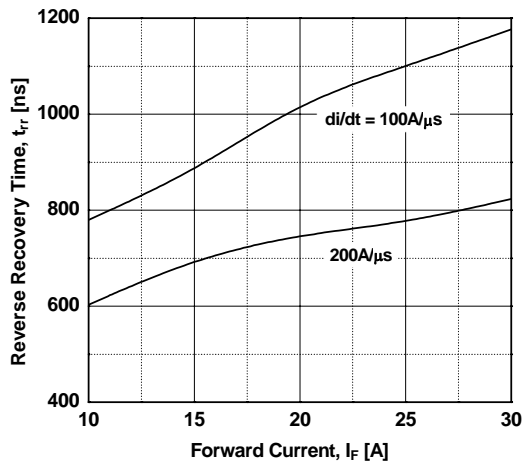
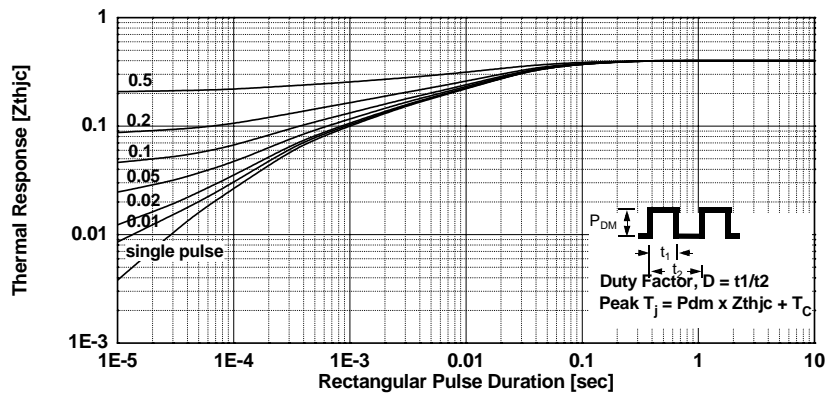
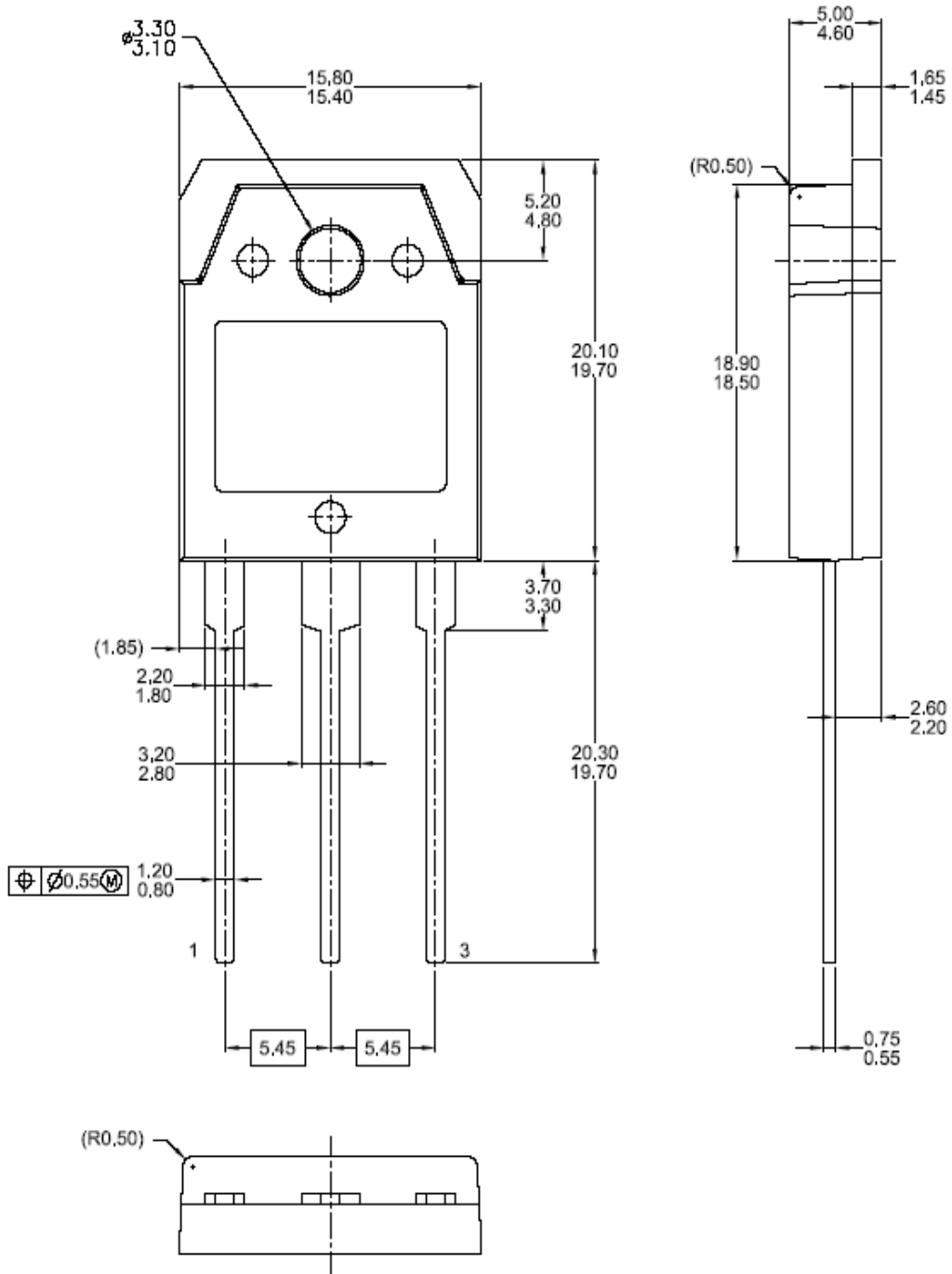

Figure 22. Transient Thermal Impedance of IGBT



Mechanical Dimensions

TO-3PN



Dimensions in Millimeters



TRADEMARKS

The following includes registered and unregistered trademarks and service marks, owned by Fairchild Semiconductor and/or its global subsidiaries, and is not intended to be an exhaustive list of all such trademarks.

- | | | | |
|---|---|---|---|
| ACEx® | FPS™ | PDP-SPM™ | The Power Franchise® |
| Build it Now™ | F-PFS™ | Power-SPM™ | the power franchise |
| CorePLUS™ | FRFET® | PowerTrench® | TinyBoost™ |
| CorePOWER™ | Global Power ResourceSM | Programmable Active Droop™ | TinyBuck™ |
| CROSSVOLT™ | Green FPS™ | QFET® | TinyLogic® |
| CTL™ | Green FPS™ e-Series™ | QST™ | TINYOPTO™ |
| Current Transfer Logic™ | GTO™ | Quiet Series™ | TinyPower™ |
| EcoSPARK® | IntelliMAX™ | RapidConfigure™ | TinyPWM™ |
| EfficientMax™ | ISOPLANAR™ | Saving our world 1mW at a time™ | TinyWire™ |
| EZSWITCH™ * | MegaBuck™ | SmartMax™ | µSerDes™ |
|  ™ | MICROCOUPLER™ | SMART START™ |  ™ |
|  ™ | MicroFET™ | SPM® | UHC® |
| Fairchild® | MicroPak™ | STEALTH™ | Ultra FRFET™ |
| Fairchild Semiconductor® | MillerDrive™ | SuperFET™ | UniFET™ |
| FACT Quiet Series™ | MotionMax™ | SuperSOT™-3 | VCX™ |
| FACT® | Motion-SPM™ | SuperSOT™-6 | VisualMax™ |
| FAST® | OPTOLOGIC® | SuperSOT™-8 | |
| FastvCore™ | OPTOPLANAR® | SuperMOS™ | |
| FlashWriter® * |  ® |  ® | |

* EZSWITCH™ and FlashWriter® are trademarks of System General Corporation, used under license by Fairchild Semiconductor.

DISCLAIMER

FAIRCHILD SEMICONDUCTOR RESERVES THE RIGHT TO MAKE CHANGES WITHOUT FURTHER NOTICE TO ANY PRODUCTS HEREIN TO IMPROVE RELIABILITY, FUNCTION, OR DESIGN. FAIRCHILD DOES NOT ASSUME ANY LIABILITY ARISING OUT OF THE APPLICATION OR USE OF ANY PRODUCT OR CIRCUIT DESCRIBED HEREIN; NEITHER DOES IT CONVEY ANY LICENSE UNDER ITS PATENT RIGHTS, NOR THE RIGHTS OF OTHERS. THESE SPECIFICATIONS DO NOT EXPAND THE TERMS OF FAIRCHILD'S WORLDWIDE TERMS AND CONDITIONS, SPECIFICALLY THE WARRANTY THEREIN, WHICH COVERS THESE PRODUCTS.

LIFE SUPPORT POLICY

FAIRCHILD'S PRODUCTS ARE NOT AUTHORIZED FOR USE AS CRITICAL COMPONENTS IN LIFE SUPPORT DEVICES OR SYSTEMS WITHOUT THE EXPRESS WRITTEN APPROVAL OF FAIRCHILD SEMICONDUCTOR CORPORATION.

As used herein:

- Life support devices or systems are devices or systems which, (a) are intended for surgical implant into the body or (b) support or sustain life, and (c) whose failure to perform when properly used in accordance with instructions for use provided in the labeling, can be reasonably expected to result in a significant injury of the user.
- A critical component in any component of a life support, device, or system whose failure to perform can be reasonably expected to cause the failure of the life support device or system, or to affect its safety or effectiveness.

PRODUCT STATUS DEFINITIONS

Definition of Terms

| Datasheet Identification | Product Status | Definition |
|--------------------------|------------------------|--|
| Advance Information | Formative or In Design | This datasheet contains the design specifications for product development. Specifications may change in any manner without notice. |
| Preliminary | First Production | This datasheet contains preliminary data; supplementary data will be published at a later date. Fairchild Semiconductor reserves the right to make changes at any time without notice to improve design. |
| No Identification Needed | Full Production | This datasheet contains final specifications. Fairchild Semiconductor reserves the right to make changes at any time without notice to improve the design. |
| Obsolete | Not In Production | This datasheet contains specifications on a product that is discontinued by Fairchild Semiconductor. The datasheet is for reference information only. |