

300MHz Single Supply Video Amplifier with Low In/Out Rail

- **Bandwidth: 300MHz**
- **Single supply operation down to 3V**
- **Low input & output rail**
- **Very low harmonic distortion**
- **Slew rate: 400V/μs**
- **Voltage Input noise: 7nV/√Hz**
- **Specified for 150Ω load and 100Ω load**
- **Tested on 5V power supply**
- **Data min. and max. are tested during production (Table 3)**

Description

The TSH341 is a single supply operational amplifier featuring a large bandwidth of 300MHz at unity gain for only 9.8mA of quiescent current.

An **advantage** of this circuit is its low input and output rail feature which is very close to GND in single supply. This rail is tested and guaranteed during production at 60mV (max.) from GND on a 150Ω load. This allows a good output swing which fits perfectly when driving a video signal on a 75Ω video line. *Chapter 5* gives technical support when using the TSH341 as a driver for video DAC output on a video line. In particular, this chapter focuses on applying a video signal DC shift to avoid any clamping of the synchronization tip.

The TSH341 is available in the tiny SOT23-5 and SO8 plastic packages.

Order Codes

Part Number	Temperature Range	Package	Packaging	Marking
TSH341ILT	-40°C to +85°C	SOT23-5	Tape & Reel	K307
TSH341ID		SO-8	Tube	H341I
TSH341IDT			Tape & Reel	H341I

Pin Connections (top view)

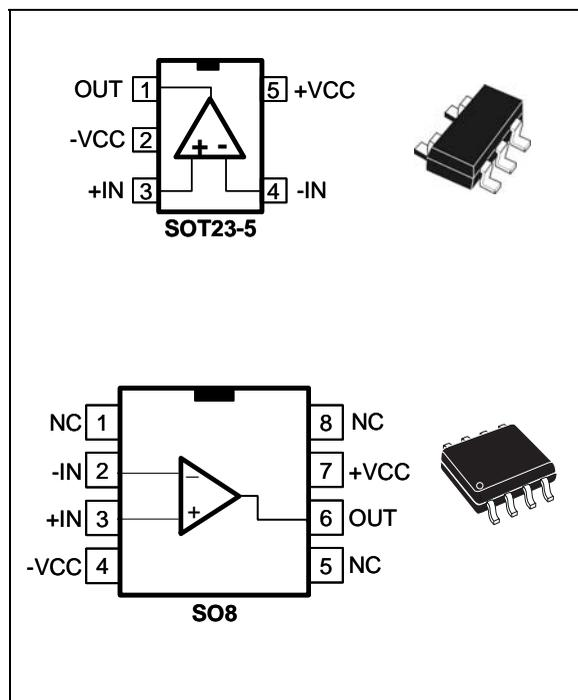

Applications

- **High-end video systems**
- **High Definition TV (HDTV)**
- **Broadcast video**
- **Multimedia products**

1 Absolute Maximum Ratings

Table 1. Key parameters and their absolute maximum ratings

Symbol	Parameter	Value	Unit
V_{CC}	Supply voltage ¹	6	V
V_{id}	Differential Input Voltage ²	+/-0.5	V
V_{in}	Input Voltage Range ³	-0.2 to +3	V
T_{oper}	Operating Free Air Temperature Range	-40 to +85	°C
T_{std}	Storage Temperature	-65 to +150	°C
T_j	Maximum Junction Temperature	150	°C
R_{thjc}	Thermal Resistance Junction to Case SOT23-5 SO8	80	°C/W
		28	
R_{thja}	Thermal Resistance Junction to Ambient Area SOT23-5 SO8	250	°C/W
		175	
$P_{max.}$	Maximum Power Dissipation (@ $T_a=25^{\circ}C$) for $T_j=150^{\circ}C$ SOT23-5 SO8	500	mW
		715	
ESD	CDM: Charged Device Model	2	kV
	HBM: Human Body Model	1.5	kV
	MM: Machine Model	200	V
	Output Short Circuit	4	

- 1) All voltage values, except differential voltage are with respect to network terminal.
- 2) Differential voltage are non-inverting input terminal with respect to the inverting input terminal.
- 3) The magnitude of input and output voltage must never exceed $V_{CC} + 0.3V$.
- 4) An output current limitation protects the circuit from transient currents. Short-circuits can cause excessive heating. Destructive dissipation can result from short circuit on amplifiers.

Table 2. Operating conditions

Symbol	Parameter	Value	Unit
V_{CC}	Power Supply Voltage	3 to 5.5 ¹	V
V_{icm}	Common Mode Input Voltage	-0.4 to 3	V

- 1) Tested in full production at 0V/5V single power supply

2 Electrical Characteristics

Table 3. $V_{CC} = +5V$, $T_{amb} = 25^{\circ}C$ (unless otherwise specified)

Symbol	Parameter	Test Condition	Min.	Typ.	Max.	Unit
DC Performance						
V_{io}	Input Offset Voltage	$T_{amb}, V_{icm}=0.6V$	-15	-3	15	mV
		$-40^{\circ}C < T_{amb} < +85^{\circ}C$		-5		
ΔV_{io}	V_{io} drift vs. Temperature	$-40^{\circ}C < T_{amb} < +85^{\circ}C$		-30		$\mu V/^{\circ}C$
I_{ib}	Input Bias Current	$T_{amb}, V_{icm}=0.6V$		6	16	μA
		$-40^{\circ}C < T_{amb} < +85^{\circ}C$		7.2		
A_{VD}	Open Loop Gain	$\Delta V_{OUT}=2V, R_L=150\Omega$	70	100		dB
CMR	Common Mode Rejection Ratio $20 \log (\Delta V_{icm}/\Delta V_{io})$	$\Delta V_{icm} = 2V$	-60	-85		dB
		$-40^{\circ}C < T_{amb} < +85^{\circ}C$		-83		
SVR	Supply Voltage Rejection Ratio $20 \log (\Delta V_{cc}/\Delta V_{io})$	$\Delta V_{cc}=4V \text{ to } 5V, V_{icm}=0.6V$	-60	-85		dB
		$-40^{\circ}C < T_{amb} < +85^{\circ}C$		-84		
PSR	Power Supply Rejection Ratio $20 \log (\Delta V_{cc}/\Delta V_{out})$	$\Delta V_{cc}=200mVp-p, F=1MHz$		-77		dB
R_{IN}	Input Resistance			8.2		$M\Omega$
C_{IN}	Input Capacitance			3.5		pF
ICC	Total Supply Current	No Load, $V_{icm}=0.6V$		9.8	12.7	mA
Dynamic Performance and Output Characteristics						
Bw	-3dB Bandwidth	Small Signal $V_{OUT}=20mVp$ $V_{icm}=0.6V, R_L=150\Omega$ Gain=+1 Gain=+2	90	300 150		MHz
	Gain Flatness @ 0.1dB	Small Signal $V_{OUT}=20mVp$ Gain=+2, $V_{icm}=0.6V,$ $R_L=150\Omega$		65		
FPBW	Full Power Bandwidth	$V_{icm}=2V, V_{OUT} = 2Vp-p,$ Gain=1, $R_L = 150\Omega$	70	100		MHz
SR	Slew Rate	$V_{OUT}=2Vp-p, R_L=150\Omega,$ Gain=+2,		400		$V/\mu s$
V_{OH}	High Level Output Voltage	$R_L = 150\Omega$	3.7	3.9		V
V_{OL}	Low Level Output Voltage	$R_L = 150\Omega$		40	60	mV
I_{OUT}	Output Short Circuit Current	T_{amb}	70	100		mA
		$-40^{\circ}C < T_{amb} < +85^{\circ}C$		90		
Noise and Distortion						
eN	Equivalent Input Noise Voltage	$F = 100kHz$		7		nV/\sqrt{Hz}
iN	Equivalent Input Noise Current (+)	$F = 100kHz$		1.5		pA/\sqrt{Hz}
HD2	2nd Harmonic Distortion	$V_{OUT}= 2Vp-p, R_L = 150\Omega$ Gain=+2, $F= 10MHz,$		-57		dBc
HD3	3rd Harmonic Distortion	$V_{OUT}= 2Vp-p, R_L = 150\Omega$ Gain=+2, $F= 10MHz,$		-63		dBc

Figure 1. Frequency response

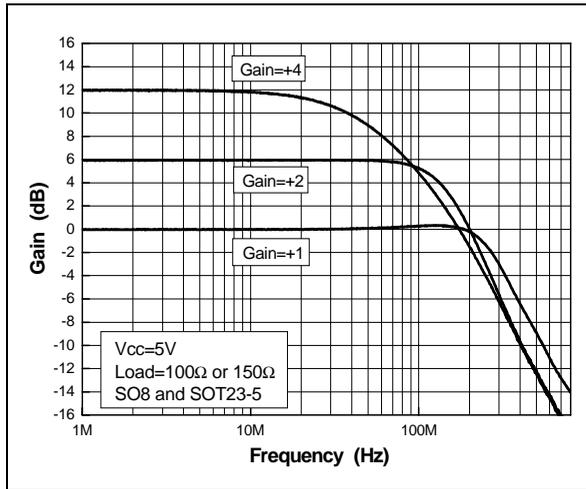

Figure 4. Frequency response on capa-load

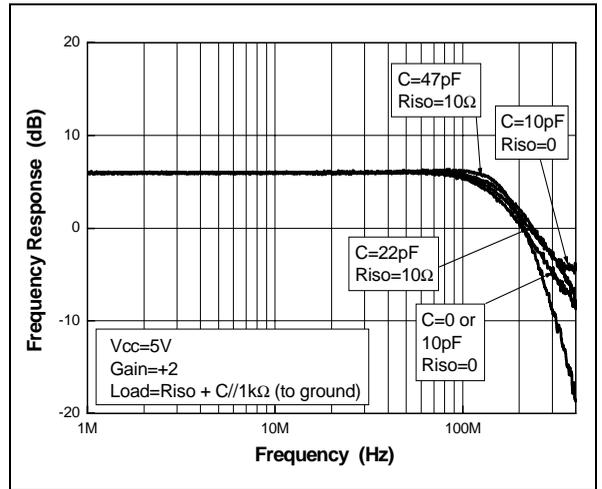

Figure 2. Gain flatness - SOT23-5L

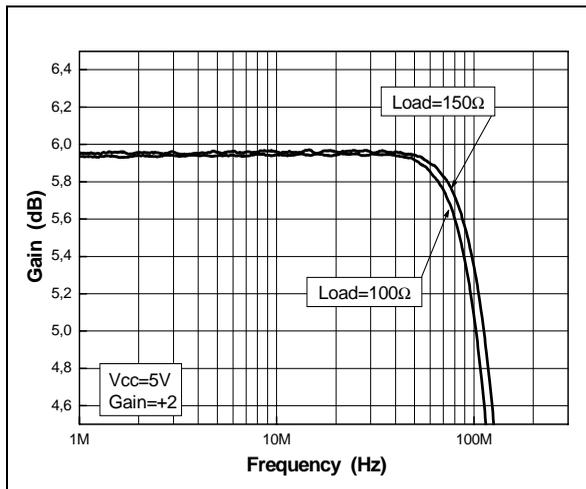

Figure 5. Gain flatness - SO8

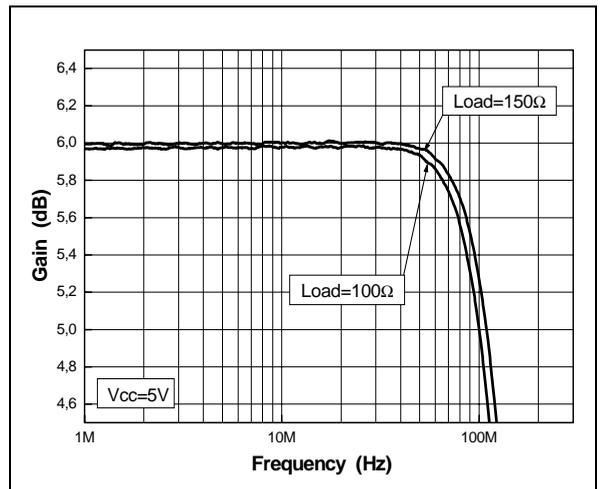

Figure 3. Total input noise vs. frequency

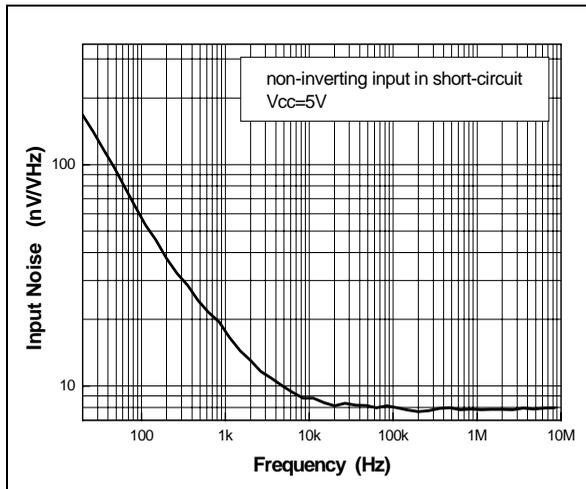

Figure 6. Positive and negative slew rate

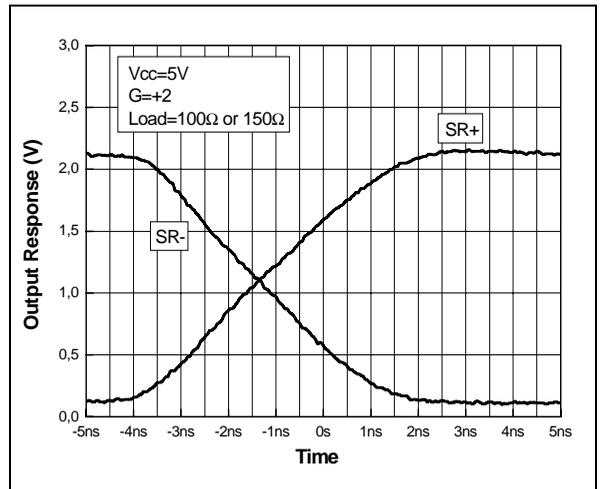

Figure 7. Distortion on 100Ω load

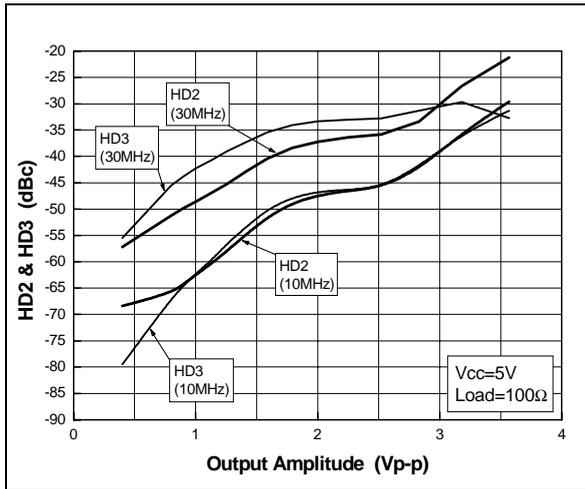

Figure 10. Distortion on 150Ω load

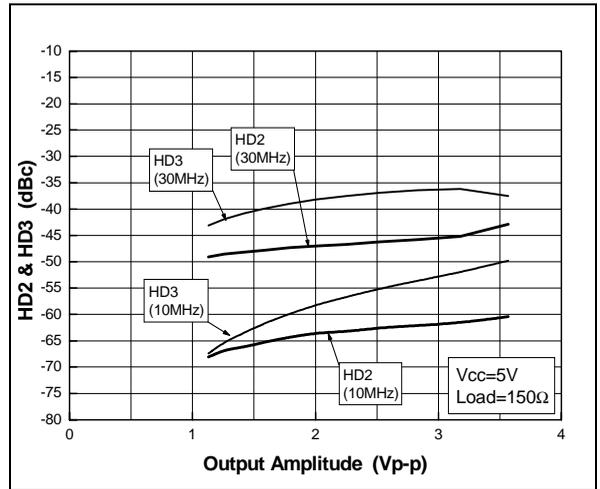

Figure 8. Output lower rail vs. frequency

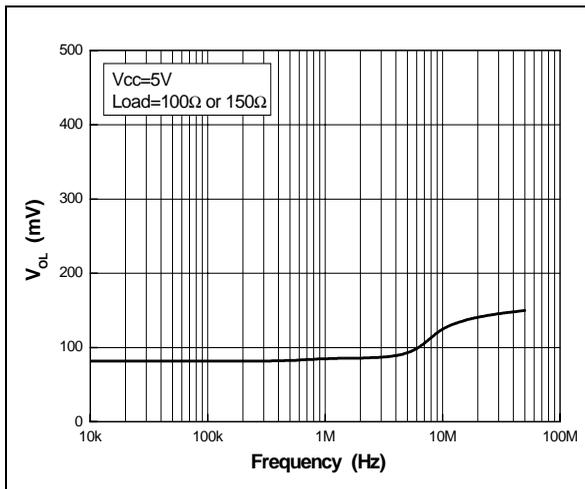

Figure 11. Output voltage swing vs. Vcc

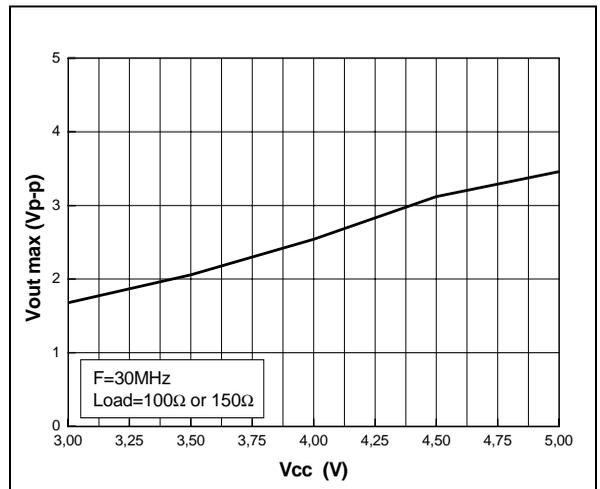

Figure 9. Output voltage swing vs. frequency

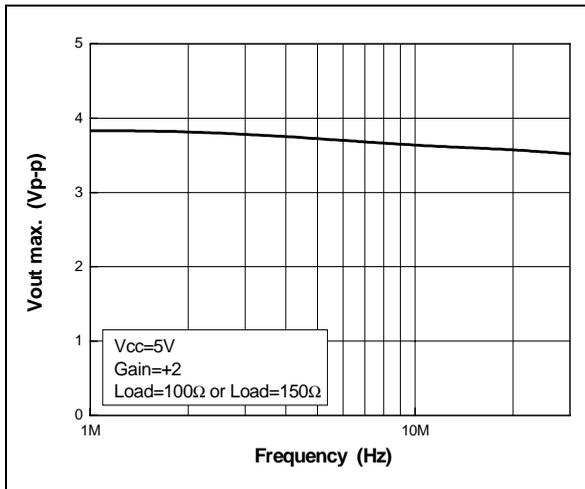

Figure 12. Quiescent current vs. Vcc

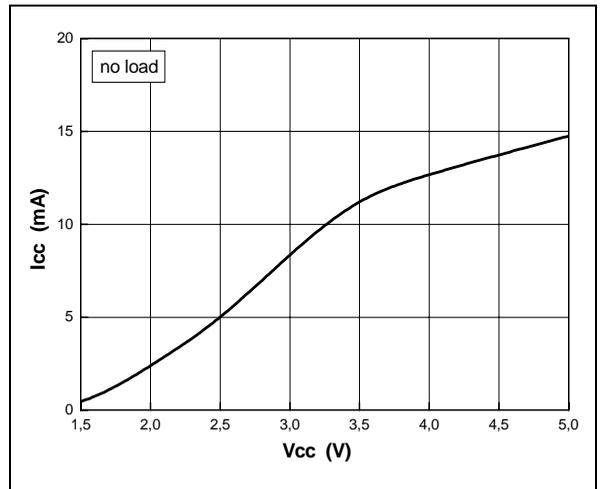

Figure 13. Isource

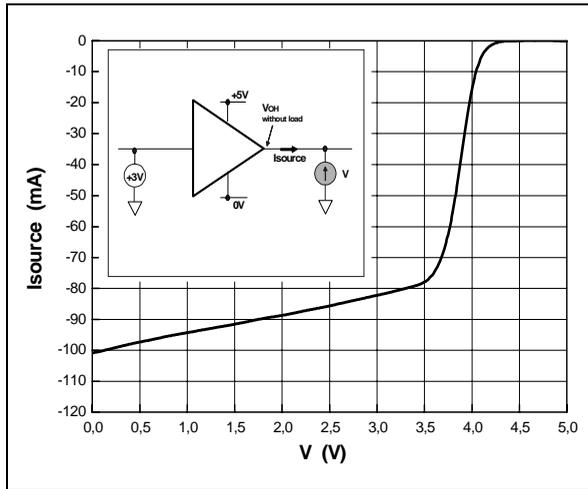

Figure 16. Reverse isolation vs. frequency

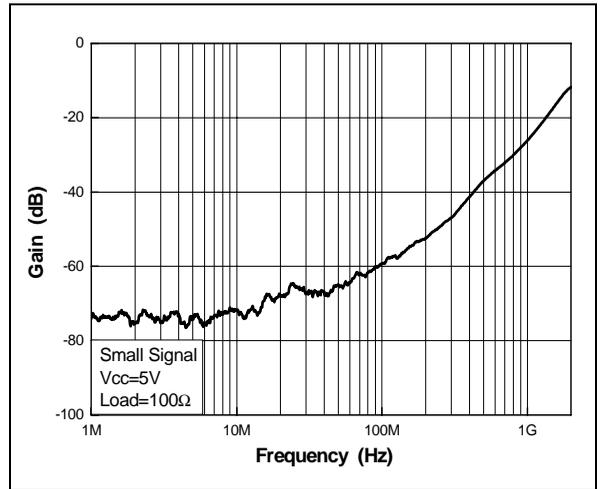

Figure 14. Bandwidth vs. temperature

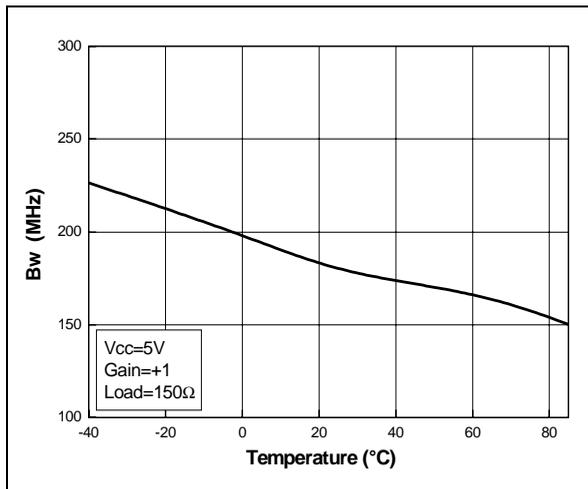

Figure 17. Ibias vs. temperature

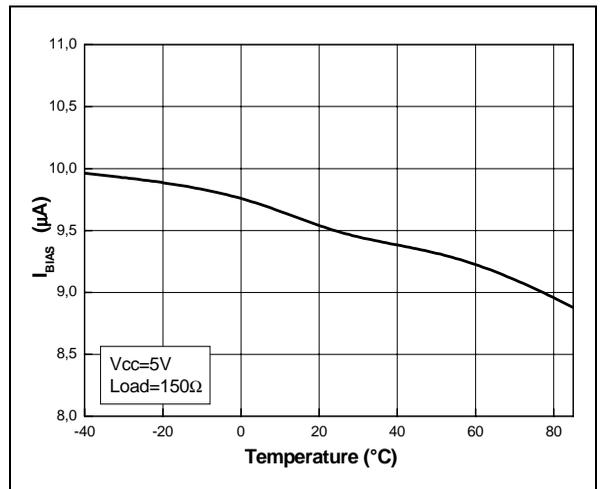

Figure 15. Input offset vs. temperature

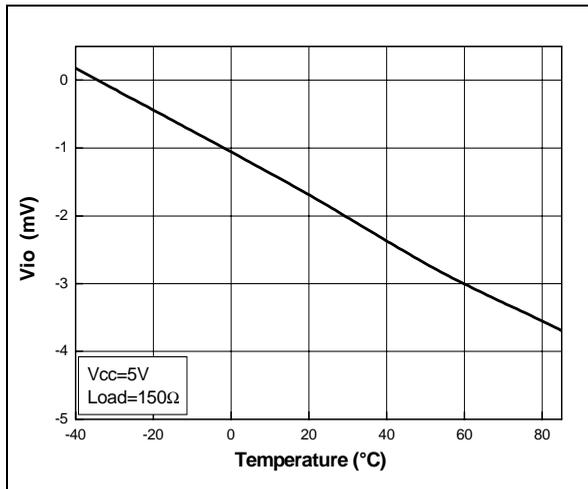

Figure 18. Supply current vs. temperature

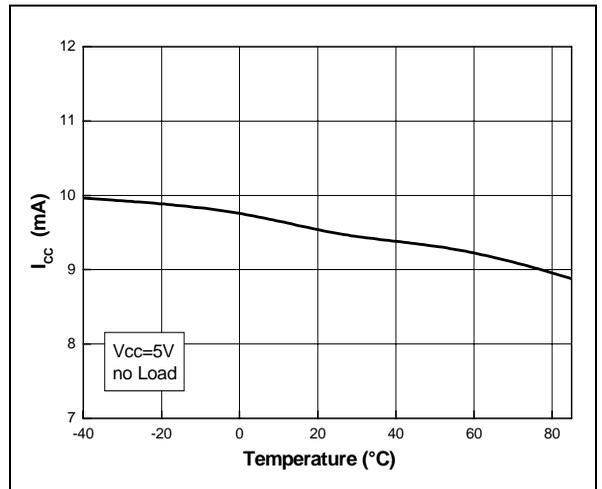

Figure 19. Output lower rail vs. temperature

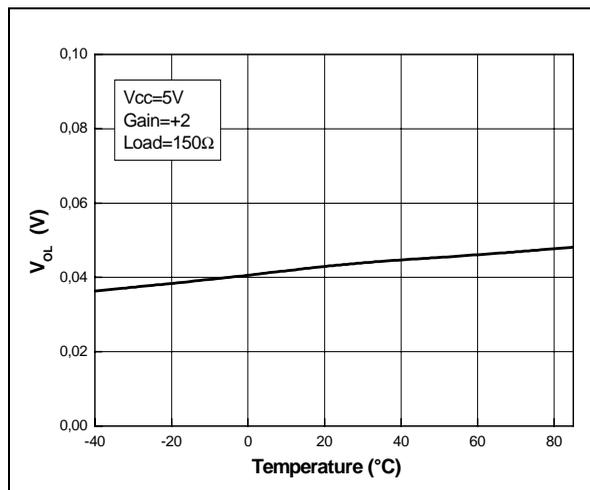

Figure 21. Output higher rail vs. temperature

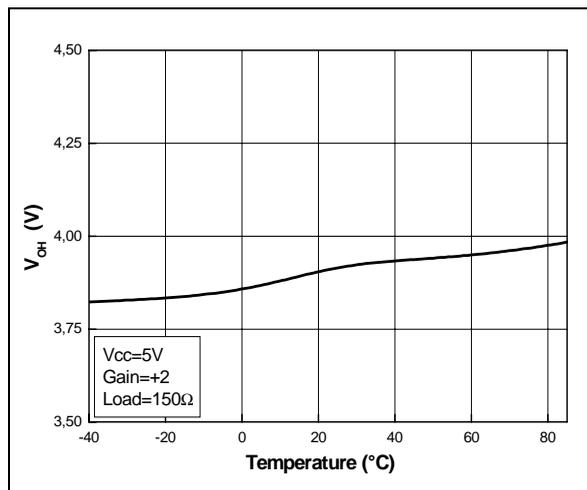

Figure 20. SVR vs. temperature

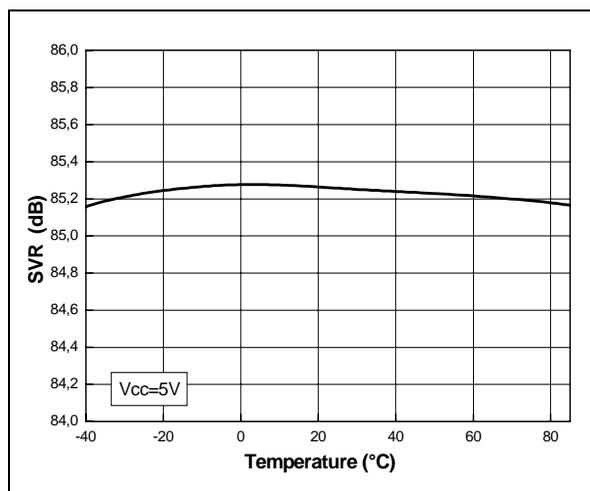
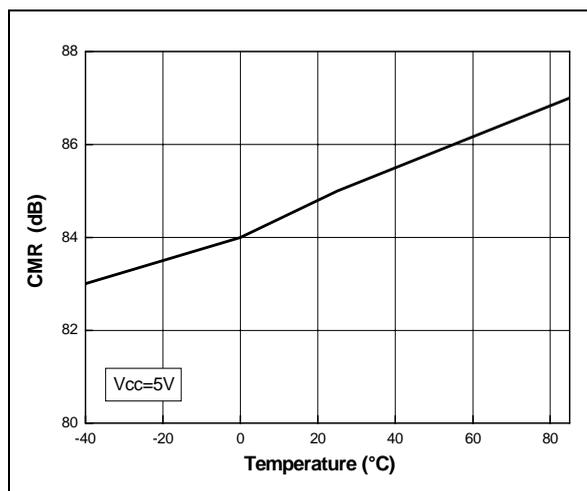

Figure 22. CMR vs. temperature



3 Evaluation Boards

An evaluation board kit optimized for high speed operational amplifiers is available (order code: KITHSEVAL/STDL). The kit includes the following evaluation boards, as well as a CD-ROM containing datasheets, articles, application notes and a user manual:

- SOT23_SINGLE_HF BOARD: Board for the evaluation of a single high-speed op-amp in SOT23-5 package.
- SO8_SINGLE_HF: Board for the evaluation of a single high-speed op-amp in SO8 package.
- SO8_DUAL_HF: Board for the evaluation of a dual high-speed op-amp in SO8 package.
- SO8_S_MULTI: Board for the evaluation of a single high-speed op-amp in SO8 package in inverting and non-inverting configuration, dual and single supply.
- SO14_TRIPLE: Board for the evaluation of a triple high-speed op-amp in SO14 package with video application considerations.

Board material:

- 2 layers
- FR4 ($\epsilon_r=4.6$)
- epoxy 1.6mm
- copper thickness: 35 μ m

Figure 23: Evaluation kit for high speed op-amps



4 Power Supply Considerations

Correct power supply bypassing is very important for optimizing performance in high-frequency ranges. Bypass capacitors should be placed as close as possible to the IC pins to improve high-frequency bypassing. A capacitor greater than $10\mu\text{F}$ is necessary to minimize the distortion. For better quality bypassing, a capacitor of 10nF is added using the same implementation conditions. Bypass capacitors must be incorporated for both the negative and the positive supply. On the SO8_SINGLE_HF board, these capacitors are C8 and C6.

Figure 24: Circuit for power supply bypassing

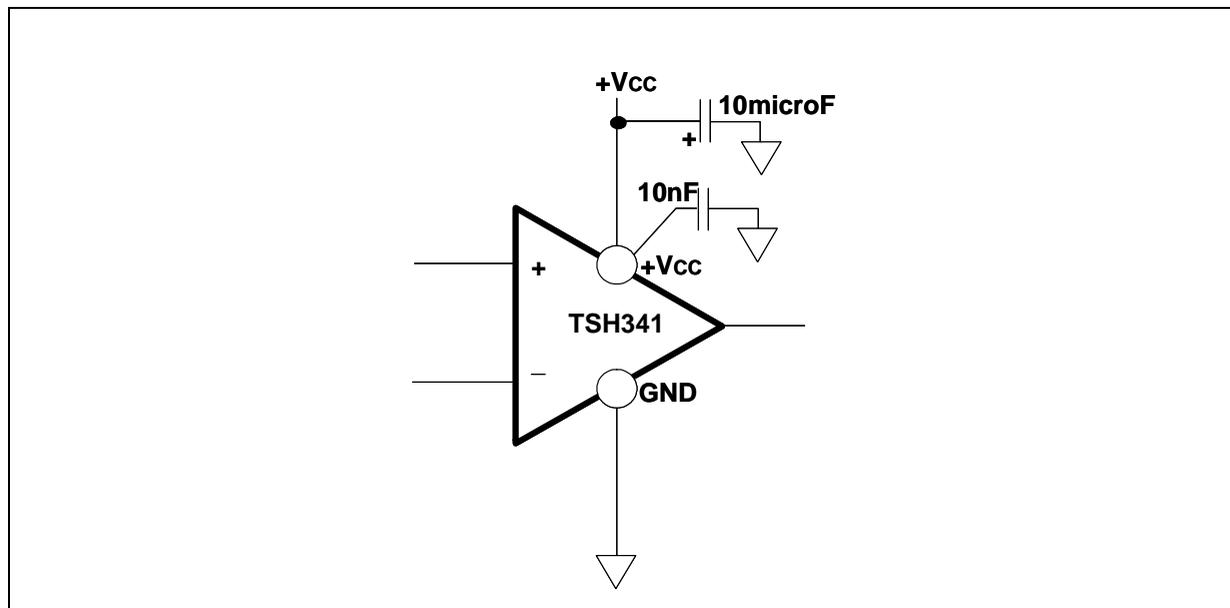

5 Using the TSH341 to Drive Video Signals

Figure 25. Implementation of the video driver on output video DACs

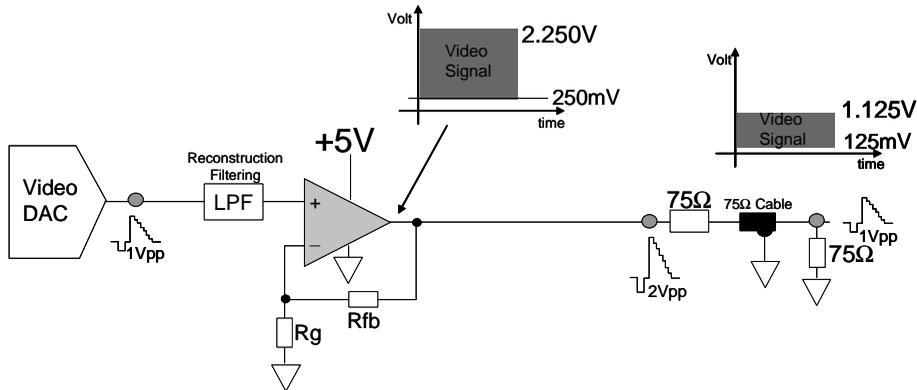

$$V_{OL}(50\text{MHz}) = 150\text{mV} \text{ (Figure 8)}$$

To drive the video signal properly, the output of the driver must be at least equal to 250mV (assuming V_{iO} and V_{OL} variations).

- **1st solution:**

Set the video DAC 0-IRE output level to 125mV.

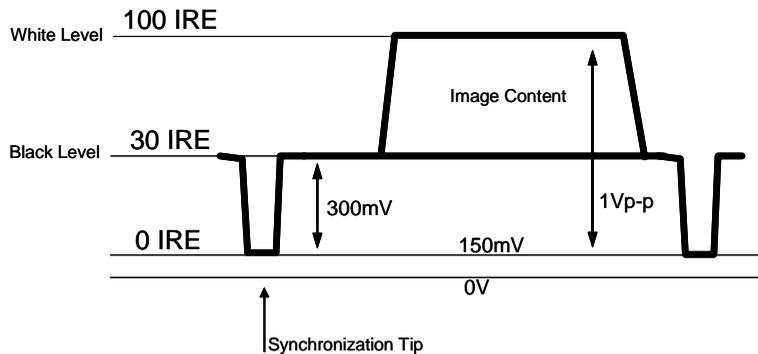

- **2nd solution:**

Implementation of a DC component in the input of the driver.

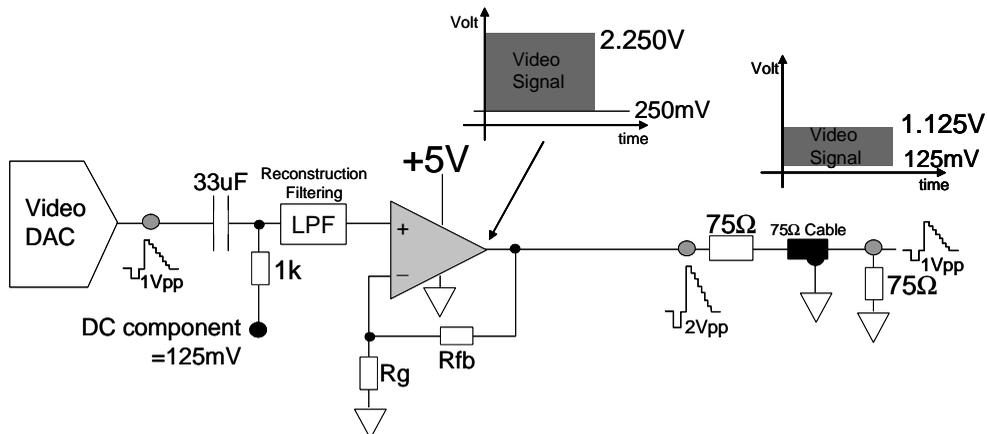

6 Package Mechanical Data

6.1 SO-8 Package

SO-8 MECHANICAL DATA

DIM.	mm.			inch		
	MIN.	TYP.	MAX.	MIN.	TYP.	MAX.
A	1.35		1.75	0.053		0.069
A1	0.10		0.25	0.04		0.010
A2	1.10		1.65	0.043		0.065
B	0.33		0.51	0.013		0.020
C	0.19		0.25	0.007		0.010
D	4.80		5.00	0.189		0.197
E	3.80		4.00	0.150		0.157
e		1.27			0.050	
H	5.80		6.20	0.228		0.244
h	0.25		0.50	0.010		0.020
L	0.40		1.27	0.016		0.050
k	8° (max.)					
ddd			0.1			0.04

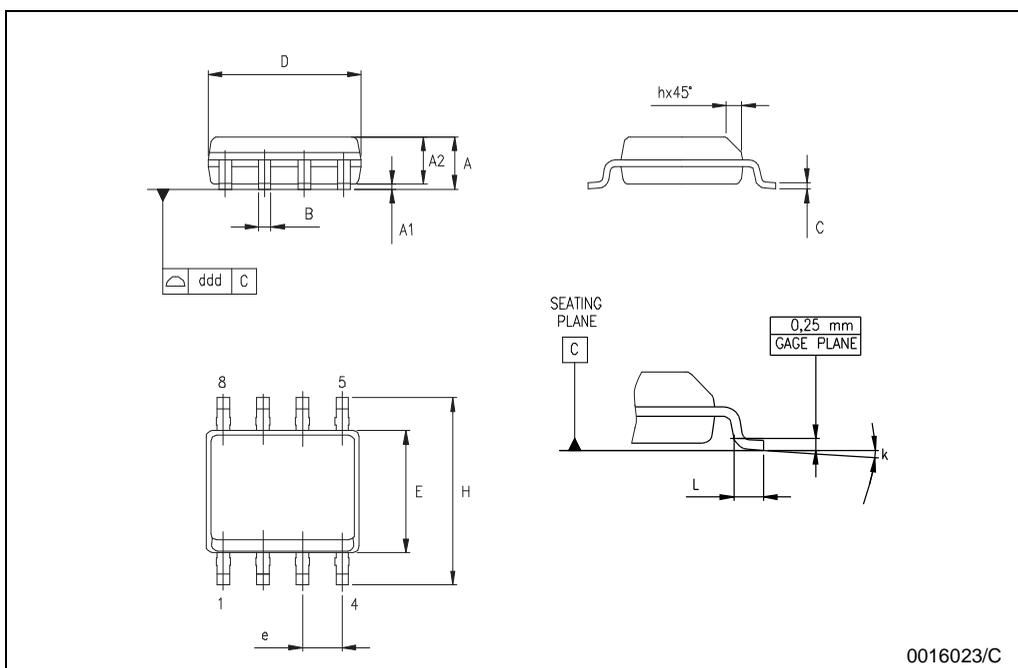

6.2 SOT23-5L (5-pin) package

SOT23-5L MECHANICAL DATA

DIM.	mm.			mils		
	MIN.	TYP.	MAX.	MIN.	TYP.	MAX.
A	0.90		1.45	35.4		57.1
A1	0.00		0.15	0.0		5.9
A2	0.90		1.30	35.4		51.2
b	0.35		0.50	13.7		19.7
C	0.09		0.20	3.5		7.8
D	2.80		3.00	110.2		118.1
E	2.60		3.00	102.3		118.1
E1	1.50		1.75	59.0		68.8
e		0.95			37.4	
e1		1.9			74.8	
L	0.35		0.55	13.7		21.6

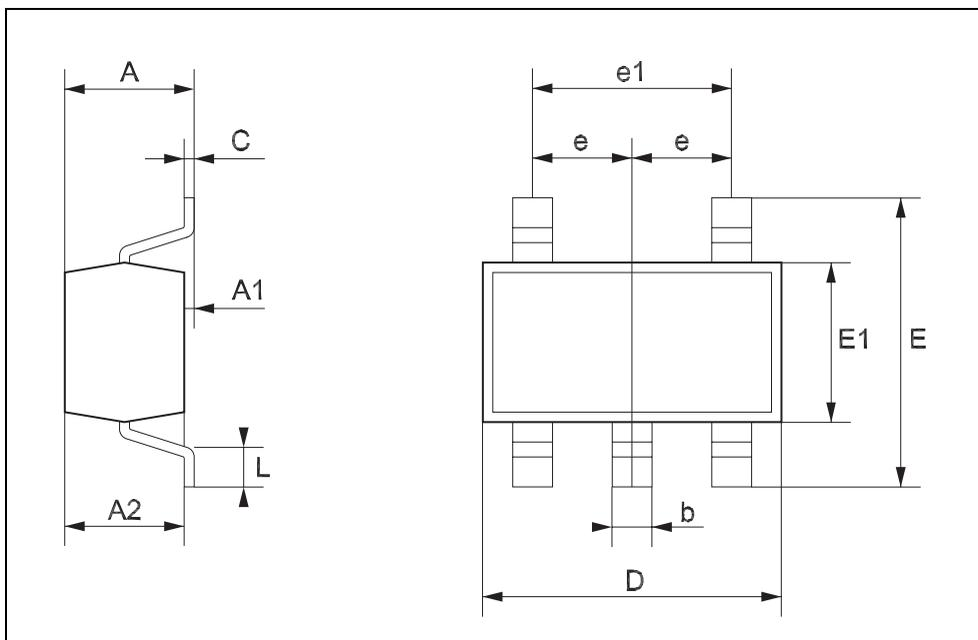

7 Revision History

Date	Revision	Description of Changes
01 Jan. 2005	1	First release corresponding to Preliminary Data version of datasheet.
23 Mar. 2005	2	Datasheet of mature, full-specification product

Information furnished is believed to be accurate and reliable. However, STMicroelectronics assumes no responsibility for the consequences of use of such information nor for any infringement of patents or other rights of third parties which may result from its use. No license is granted by implication or otherwise under any patent or patent rights of STMicroelectronics. Specifications mentioned in this publication are subject to change without notice. This publication supersedes and replaces all information previously supplied. STMicroelectronics products are not authorized for use as critical components in life support devices or systems without express written approval of STMicroelectronics.

The ST logo is a registered trademark of STMicroelectronics
All other names are the property of their respective owners

© 2005 STMicroelectronics - All rights reserved

STMicroelectronics group of companies

Australia - Belgium - Brazil - Canada - China - Czech Republic - Finland - France - Germany - Hong Kong - India - Israel - Italy - Japan - Malaysia - Malta - Morocco - Singapore - Spain - Sweden - Switzerland - United Kingdom - United States of America

www.st.com