

### Key Features

- Low-Dropout Regulator Supports Input Voltages Down to 1.4V
- Output Voltage Available in 0.9V, 1.0V, 1.2V, 1.5V, 1.8V, 2.5V, 2.8V, 2.85V, 3.0V, 3.3V
- Stable with a Ceramic Output Capacitor of 1.0uF or Higher
- Low Dropout Voltage :50mV@ 0.5A
- Low Quiescent Current
- Over Temperature Shutdown
- Low Temperature Coefficient
- Pb-Free Package

### Applications

- DSP, FPGA and Microprocessor Power Supplies
- 1.2V Core Voltage for DSPs
- LCD TV/ Monitors
- Wireless Devices
- Communication Devices
- Portable Electronics
- Post Regulator for SMPS

### General Description

The PAM3105 is a 0.5A CMOS LDO regulator that features a low quiescent current, ultra low input, output and dropout voltages, as well as over temperature shutdown. It is available in a SOT-89 package. The fixed output voltage of the PAM3105 is set at the factory and trimmed to  $\pm 2.0\%$ . The device is stable with a ceramic output capacitor of 1.0uF or higher.

This family of regulators can provide either a stand-alone power supply solution or act as a post regulator for switch mode power supplies. They are particularly well suited for applications requiring low input and output voltages.

### Typical Application

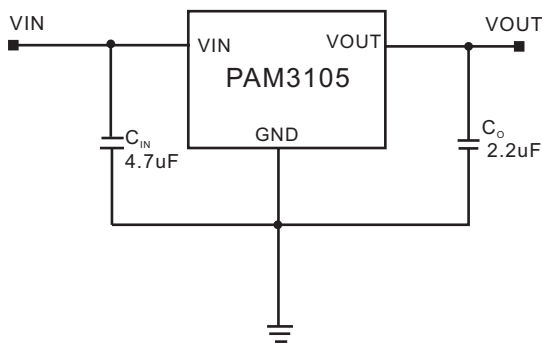

### Block Diagram

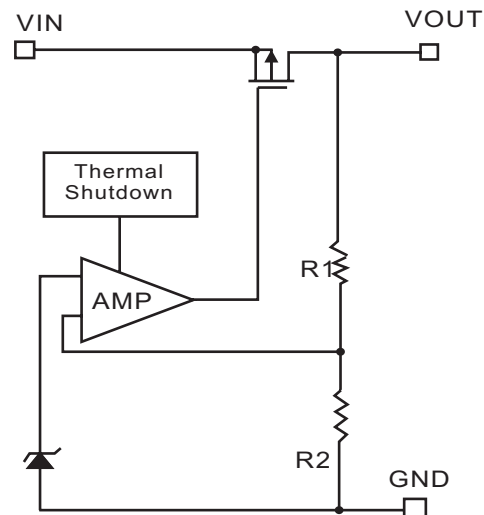

### Pin Configuration & Marking Information

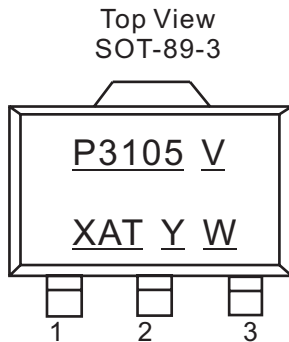

V: Voltage Code  
 X: Internal Code  
 A: Assembly Code  
 T: Testing Code  
 Y: Year  
 W: Weekly

| Pin Number | Name | Function |
|------------|------|----------|
| 1          | GND  | Ground   |
| 2          | VIN  | Input    |
| 3          | VOUT | Output   |

### Absolute Maximum Ratings

These are stress ratings only and functional operation is not implied. Exposure to absolute maximum ratings for prolonged time periods may affect device reliability. All voltages are with respect to ground.

|                                     |                          |                                   |                |
|-------------------------------------|--------------------------|-----------------------------------|----------------|
| Input Voltage.....                  | 4.0V                     | Storage Temperature.....          | -65°C to 150°C |
| Output Pin Voltage.....             | -0.3V to $V_{IN} + 0.3V$ | Maximum Junction Temperature..... | 150°C          |
| Operation Temperature Range.....    | -40°C to 85°C            | Soldering Temperature.....        | 300°C, 5sec    |
| Operation Junction Temperature..... | -40°C to 125°C           |                                   |                |

### Recommended Operating Conditions

|                                  |               |                                 |                |
|----------------------------------|---------------|---------------------------------|----------------|
| Supply Voltage Range.....        | 1.4V to 3.6V  | Junction Temperature Range..... | -40°C to 125°C |
| Operation Temperature Range..... | -40°C to 85°C |                                 |                |

### Thermal Information

| Parameter                                   | Symbol        | Package  | Maximum | Unit |
|---|---------------|----------|---------|------|
| Thermal Resistance<br>(Junction to Case)    | $\theta_{JC}$ | SOT-89-3 | 50      | °C/W |
| Thermal Resistance<br>(Junction to Ambient) | $\theta_{JA}$ | SOT-89-3 | 180     |      |
| Internal Power Dissipation                  | $P_D$         | SOT-89-3 | 550     | mW   |



### Electrical Characteristic

$V_{IN} = V_O + 0.5V$ ,  $T_A = 25^\circ C$ ,  $C_{IN} = 4.7\mu F$ ,  $C_O = 2.2\mu F$ , unless otherwise noted.

| Parameters                    | Symbol     | Test Conditions  | MIN                    | TYP | MAX | UNITS           |    |
|-------------------------------|------------|--|------------------------|-----|-----|-----------------|----|
| Input Voltage Range           | $V_{IN}$   |  | Note 1                 |     | 3.6 | V               |    |
| Output Voltage Accuracy       | $V_O$      | $I_O = 50mA$   | -2                     |     | 2   | %               |    |
| Dropout Voltage               | $V_{DROP}$ | $I_O = 100mA$  | $V_O = 0.9V$           |     | 330 | 450             | mV |
|                               |            |  | $V_O = 1.0V$           |     | 220 | 350             |    |
|                               |            |  | $2.5V > V_O \geq 1.2V$ |     | 20  | 150             |    |
|                               |            |  | $V_O \geq 2.5V$        |     | 10  | 100             |    |
|                               |            | $I_O = 500mA$  | $V_O = 0.9V$           |     | 330 | 500             |    |
|                               |            |  | $V_O = 1.0V$           |     | 220 | 400             |    |
|                               |            |  | $2.5V > V_O \geq 1.2V$ |     | 50  | 200             |    |
|                               |            |  | $V_O \geq 2.5V$        |     | 40  | 150             |    |
| Quiescent Current             | $I_Q$      | $I_O = 0mA$  |                        | 90  | 150 | $\mu A$         |    |
| Ground Pin Current            | $I_{GND}$  | $I_O = 1mA$ to $500mA$   |                        | 95  | 300 | $\mu A$         |    |
| Line Regulation               | LNR        | $V_O \leq 2.5V, I_O = 10mA$<br>$V_{IN} = V_O + 0.5V$ to $V_O + 1.5V$ |                        | 0.1 | 1   | %/ $V$          |    |
|                               |            | $V_O > 2.5V, I_O = 10mA$<br>$V_{IN} = 3.3V$ to $3.6V$                |                        |     |     |                 |    |
| Load Regulation               | LDR        | $I_O = 1mA$ to $500mA$ , $V_{IN} = V_O + 0.5V$                       |                        | 0.2 | 1.5 | %               |    |
| Over Temperature Shutdown     | OTS        |  |                        | 150 |     | $^\circ C$      |    |
| Over Temperature Hysteresis   | OTH        |  |                        | 50  |     | $^\circ C$      |    |
| Temperature Coefficient       | TC         |  |                        | 40  |     | ppm/ $^\circ C$ |    |
| Power Supply Ripple Rejection | PSRR       | $I_O = 100mA$ , $V_O = 0.9V$   | $f = 100Hz$            |     | 65  | dB              |    |
|                               |            |  | $f = 1KHz$             |     | 60  |                 |    |
|                               |            |  | $f = 10KHz$            |     | 40  |                 |    |
| Output Noise                  | $V_n$      | $f = 10Hz$ to $100kHz$   |                        | 40  |     | $\mu V_{rms}$   |    |

Note1: The minimum input voltage ( $V_{IN(MIN)}$ ) of the PAM3105 is determined by output voltage and dropout voltage. The minimum input voltage is defined as:

$$V_{IN(MIN)} = V_O + V_{drop}$$

### Typical Performance Characteristics

$T_A=25^\circ\text{C}$ ,  $C_{IN}=4.7\mu\text{F}$ ,  $C_O=2.2\mu\text{F}$ , unless otherwise noted.

1. Output Voltage vs Input Voltage

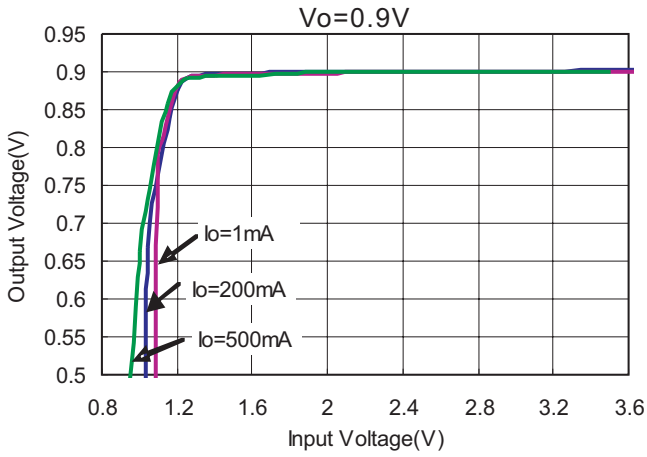

2. Output Voltage vs Output Current

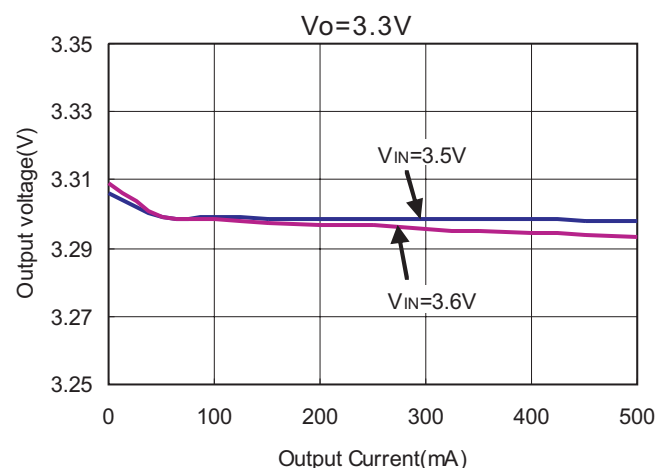
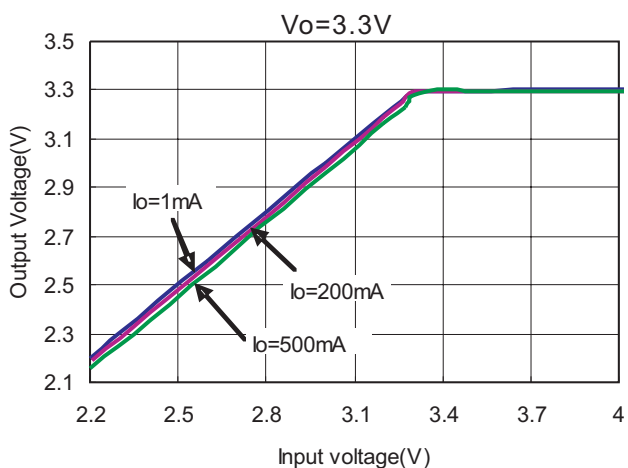
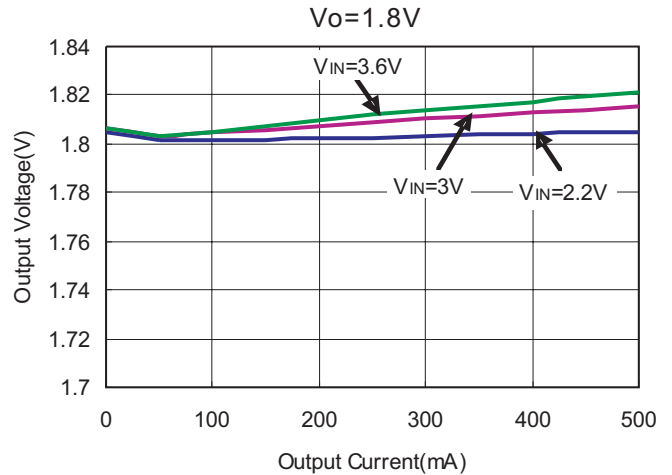
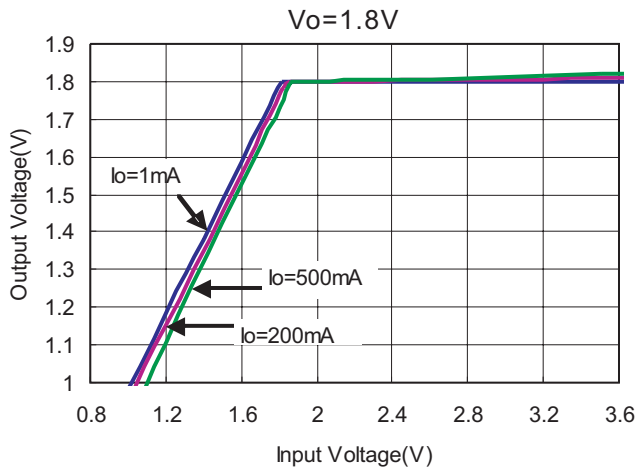
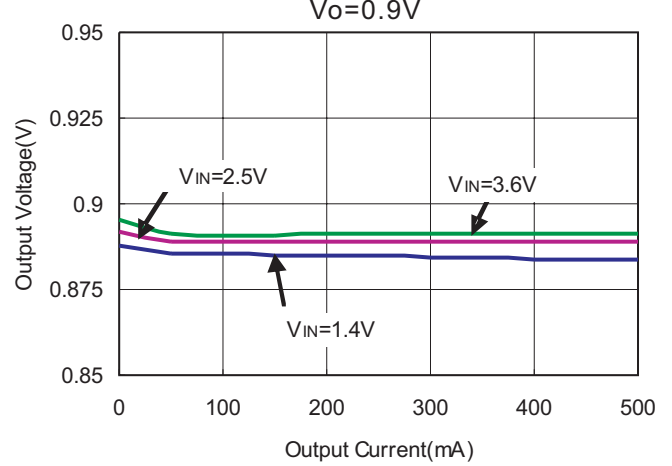

### Typical Performance Characteristics(continued)

3. Output Voltage vs Temperature

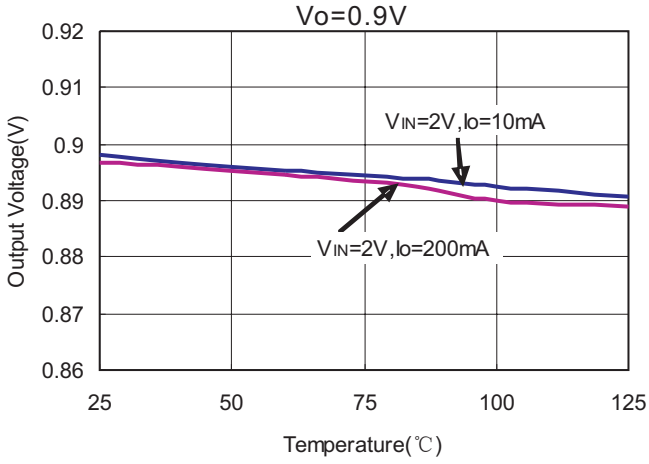

4. Dropout Voltage vs Output Current

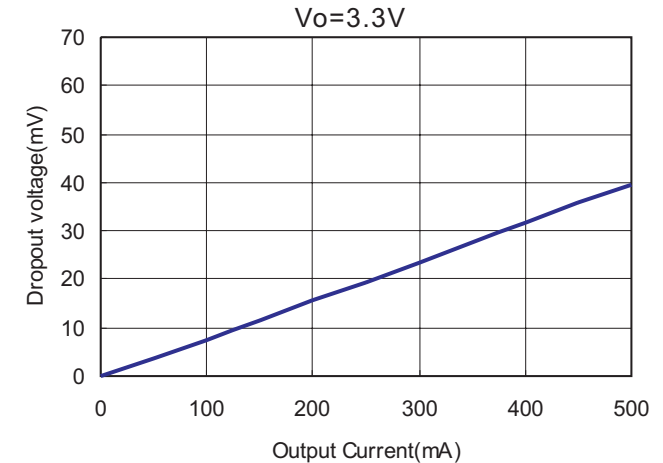
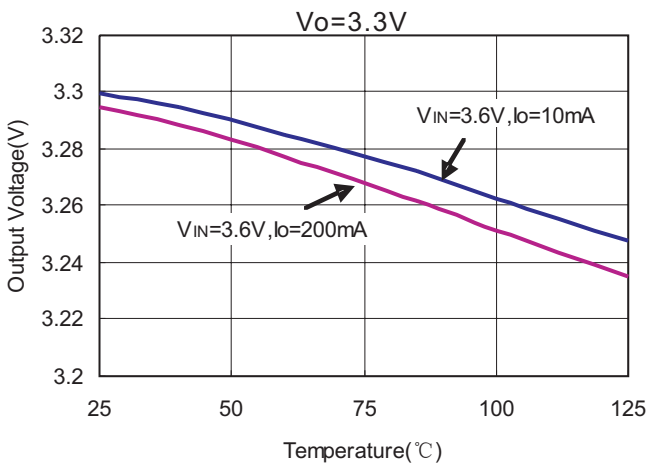
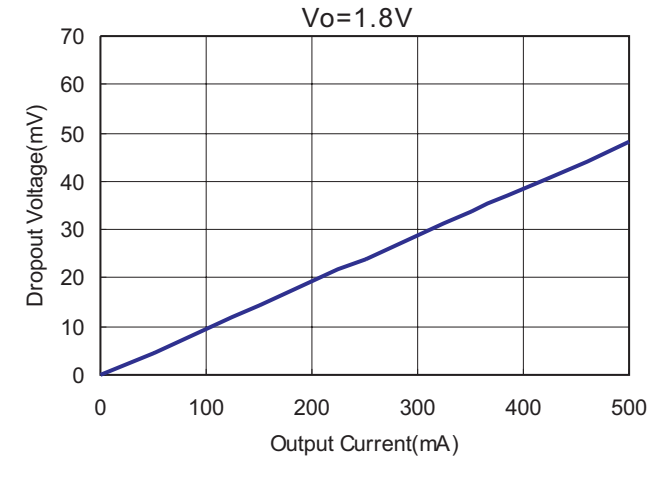
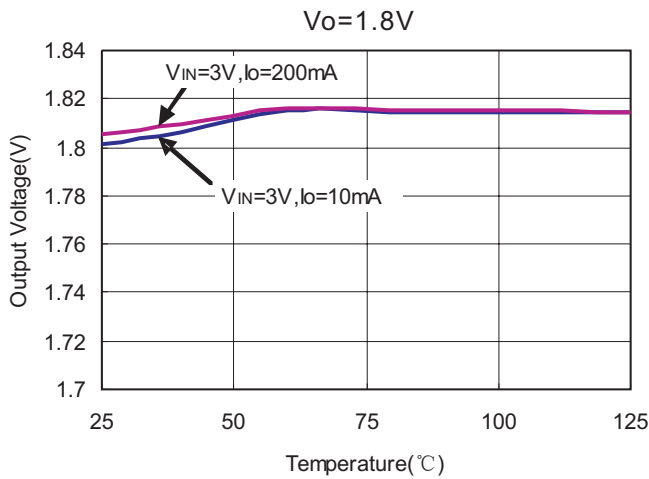
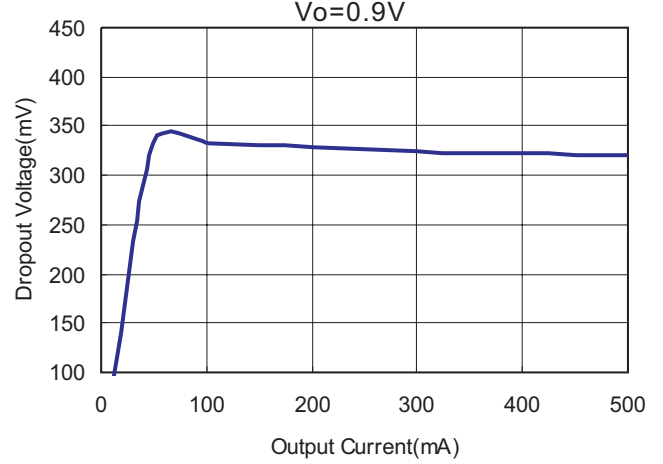

### Typical Performance Characteristics(continued)

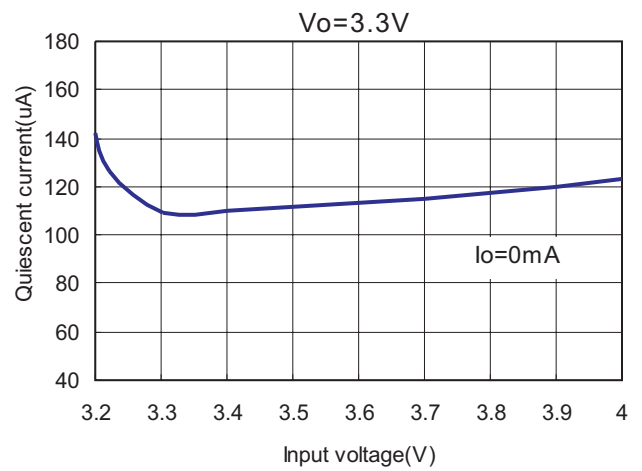
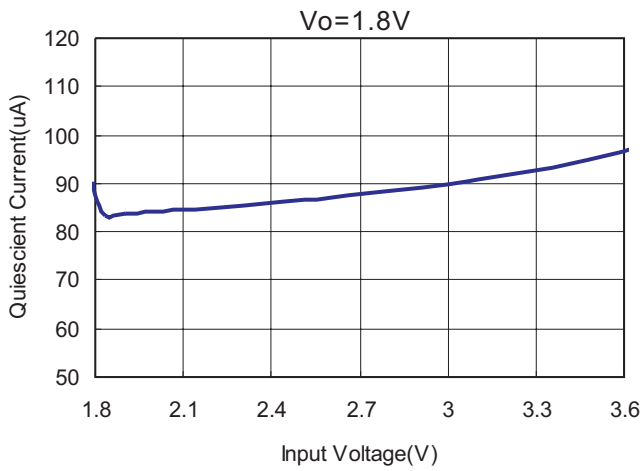
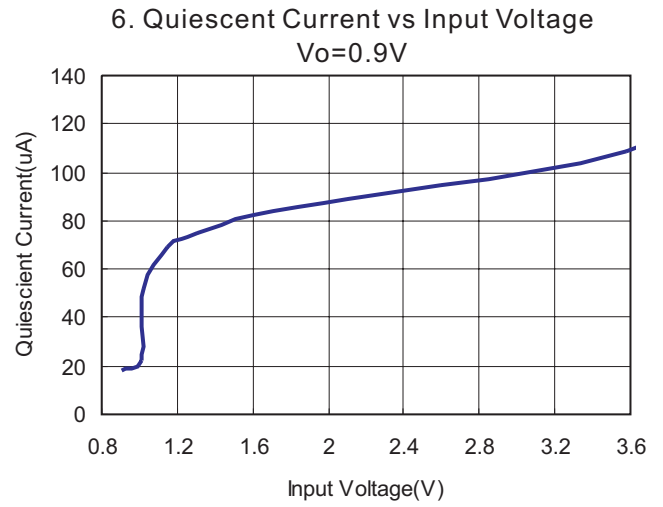
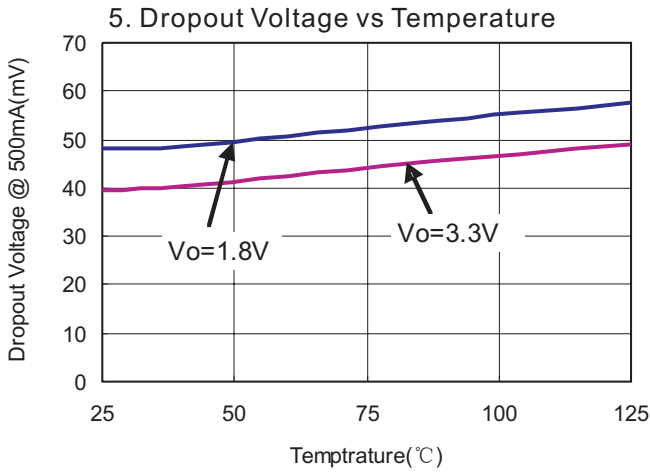

### Typical Performance Characteristics(continued)

7. Ground Current vs Input voltage

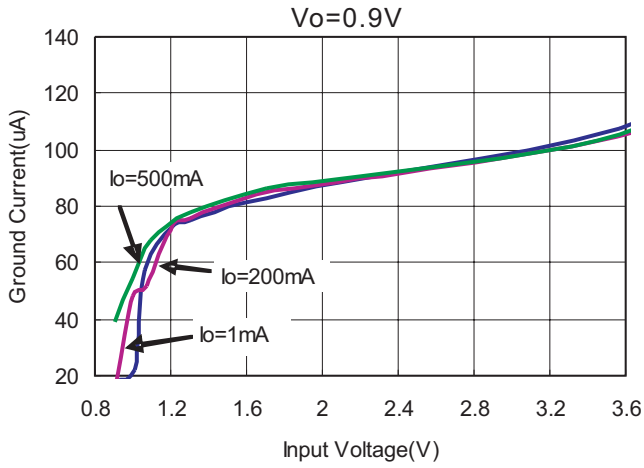

8. Ground Current vs Output Current

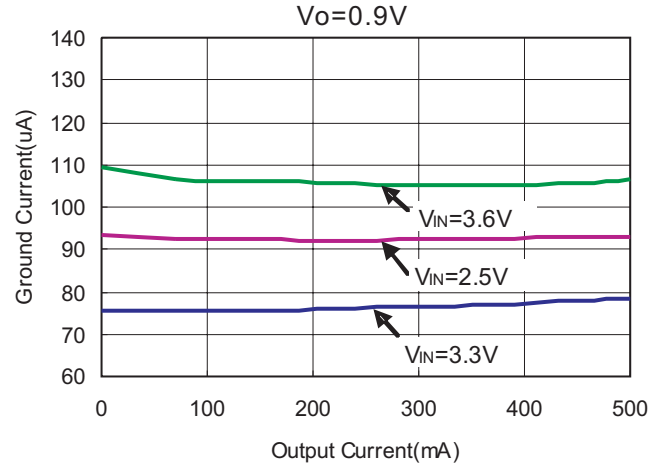

Vo=1.8V

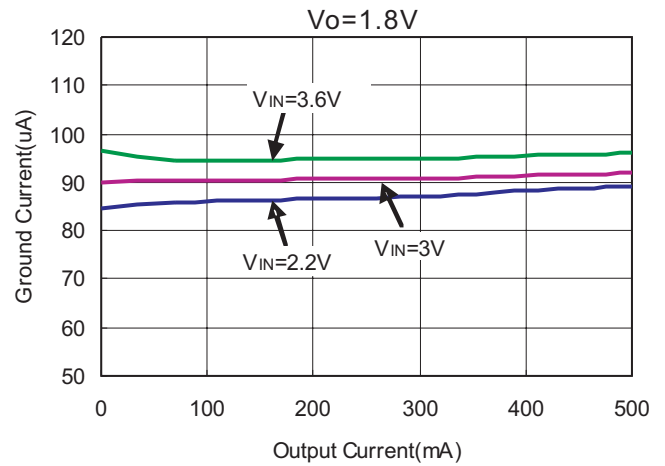
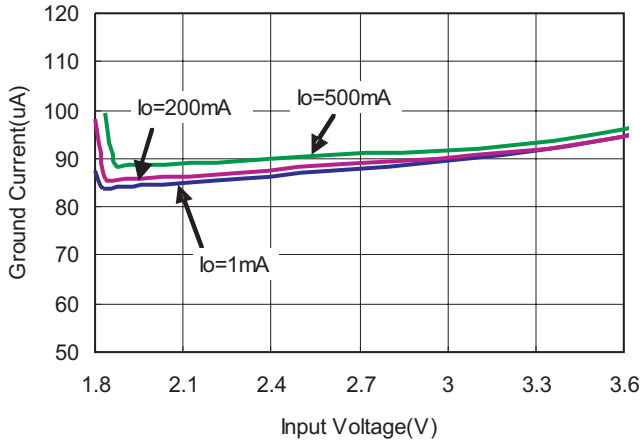

Vo=3.3V

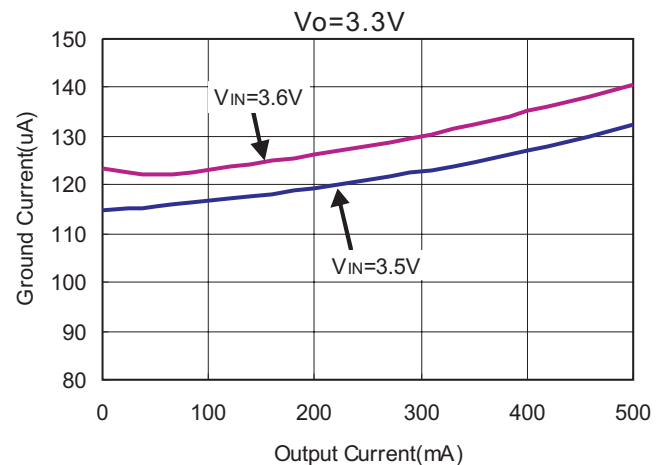
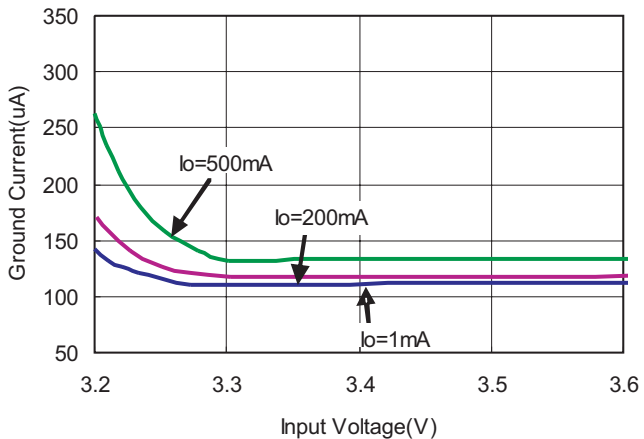

### Typical Performance Characteristics(continued)

9. Load Transient Response

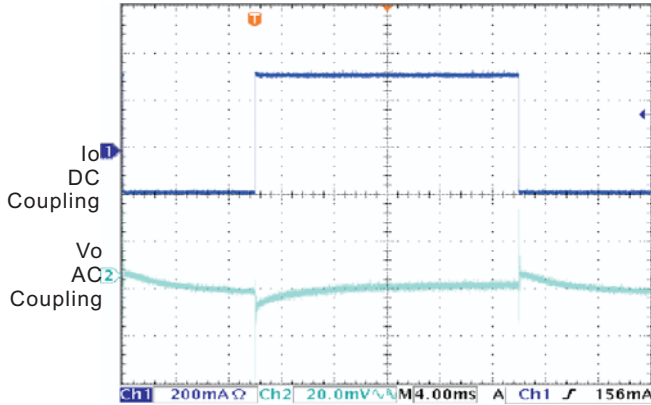

$I_o=1\text{mA}$  to  $500\text{mA}$ ,  $V_o=1.8\text{V}$ ,  $V_{IN}=3.3\text{V}$

10. Line Transient Response

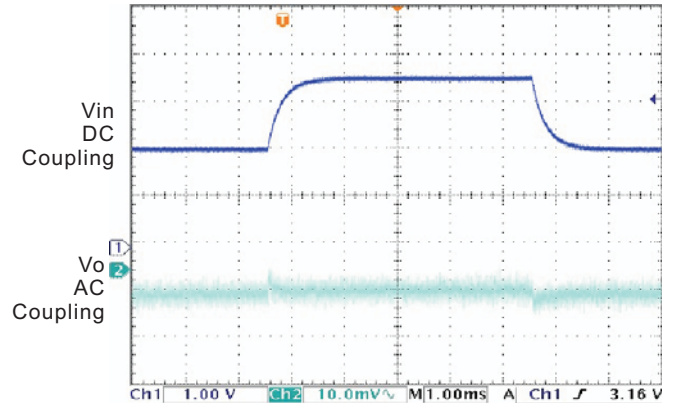

$V_{IN}=2.2\text{V}$  to  $3.6\text{V}$ ,  $V_o=1.8\text{V}$ ,  $I_o=1\text{mA}$

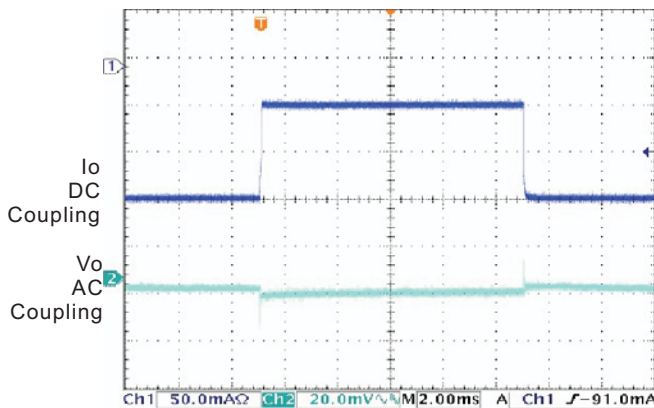

$I_o=1\text{mA}$  to  $100\text{mA}$ ,  $V_o=1.8\text{V}$ ,  $V_{IN}=3.3\text{V}$

11. Power Supply Ripple Rejection

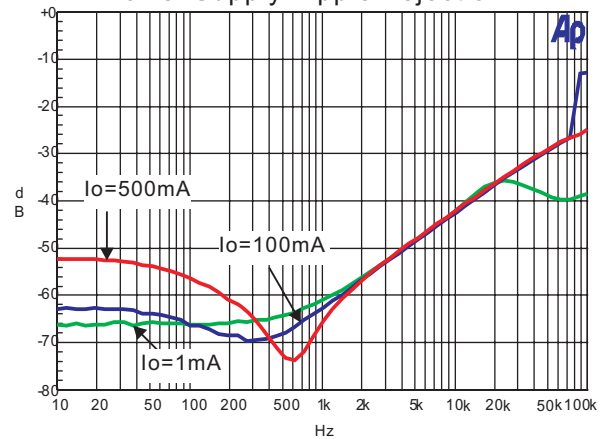

$V_o=0.9\text{V}$

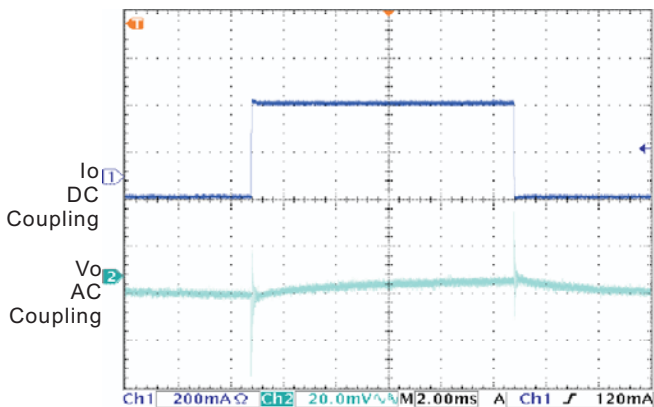

$I_o=100\text{mA}$  to  $500\text{mA}$ ,  $V_o=1.8\text{V}$ ,  $V_{IN}=3.3\text{V}$



### Application Information

The PAM3105 family of low-dropout (LDO) regulators have several features that allow them to apply to a wide range of applications. The family operates with very low input voltage (1.4V) and low dropout voltage (typically 50mV at full load), making it an efficient stand-alone power supply or post regulator for battery or switch mode power supplies. The 0.5A output current makes the PAM3105 family suitable for powering many microprocessors. The PAM3105 family also has low output noise (typically 40µVRMS with 2.2µF output capacitor), making it ideal for use in telecom equipment.

#### External Capacitor Requirements

A 2.2µF or larger ceramic input bypass capacitor, connected between VIN and GND and located close to the PAM3105, is required for stability. A 1.0µF minimum value capacitor from VOUT to GND is also required. To improve transient response, noise rejection, and ripple rejection, an additional 10µF or larger, low ESR capacitor is recommended at the output. A higher value, low ESR output capacitor may be necessary if large, fast-rise-time load transients are anticipated and the device is located several inches from the power source, especially if the minimum input voltage of 1.4 V is used.

#### Regulator Protection

The PAM3105 features internal current limiting and thermal protection. During normal operation, the PAM3105 limits output current to approximately 1A. When current limiting engages, the output voltage scales back linearly until the over current condition ends. While current limiting is designed to prevent gross device failure, care should be taken not to exceed the power dissipation ratings of the package. If the temperature of the device exceeds 150°C, thermal-protection circuitry will shut it down. Once the device has cooled down to approximately 50°C below the high temp trip point, regulator operation resumes.

#### Thermal Information

The amount of heat that an LDO linear regulator

generates is:

$$\text{Power}=(V_{\text{IN}}-V_{\text{O}})I_{\text{O}}$$

All integrated circuits have a maximum allowable junction temperature ( $T_{\text{J max}}$ ) above which normal operation is not assured. A system designer must design the operating environment so that the operating junction temperature ( $T_{\text{J}}$ ) does not exceed the maximum junction temperature ( $T_{\text{J max}}$ ). The two main environmental variables that a designer can use to improve thermal performance are air flow and external heatsinks. The purpose of this information is to aid the designer in determining the proper operating environment for a linear regulator that is operating at a specific power level.

In general, the maximum expected power ( $P_{\text{D(max)}}$ ) consumed by a linear regulator is computed as:

$$P_{\text{DMAX}}=(V_{\text{I(avg)}}-V_{\text{O(avg)}})\times I_{\text{O(avg)}}+V_{\text{I(avg)}}\times I_{\text{(Q)}} \quad (1)$$

Where:

- $V_{\text{I(avg)}}$  is the average input voltage.
- $V_{\text{O(avg)}}$  is the average output voltage.
- $I_{\text{O(avg)}}$  is the average output current.
- $I_{\text{(Q)}}$  is the quiescent current.

For most LDO regulators, the quiescent current is insignificant compared to the average output current; therefore, the term  $V_{\text{I(avg)}} \times I_{\text{(Q)}}$  can be neglected. The operating junction temperature is computed by adding the ambient temperature ( $T_{\text{A}}$ ) and the increase in temperature due to the regulator's power dissipation. The temperature rise is computed by multiplying the maximum expected power dissipation by the sum of the thermal resistances between the junction and the case ( $R_{\theta\text{JC}}$ ), the case to heatsink ( $R_{\theta\text{CS}}$ ), and the heatsink to ambient ( $R_{\theta\text{SA}}$ ). Thermal resistances are measures of how effectively an object dissipates heat. Typically, the larger the device, the more surface area available for power dissipation so that the object's thermal resistance will be lower.

### Ordering Information

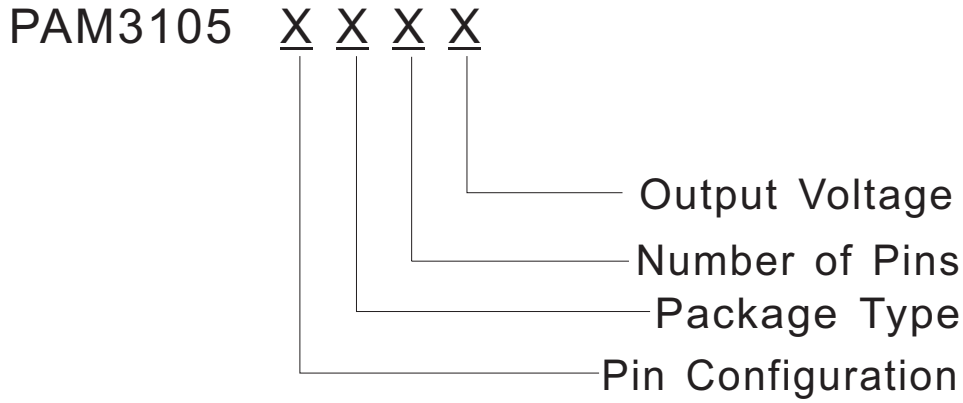

| Pin Configuration                     | Package Type | Number of Pins | Output Voltage  |
|---------------------------------------|--------------|----------------|---|
| A Type<br>1. GND<br>2. VIN<br>3. VOUT | C: SOT-89    | A: 3           | 090: 0.9V<br>100: 1.0V<br>120: 1.2V<br>150: 1.5V<br>180: 1.8V<br>250: 2.5V<br>280: 2.8V<br>285: 2.85V<br>300: 3.0V<br>330: 3.3V |

Please consult PAM sales office or authorized Rep. /Distributor for output voltage and package type availability.



### Ordering Information

| Part Number   | Output Voltage | Marking         | Package Type | Standard Package      |
|---------------|----------------|-----------------|--------------|-----------------------|
| PAM3105ACA090 | 0.9V           | P3105Z<br>XATYW | SOT-89-3     | 1,000Units/Tape &Reel |
| PAM3105ACA100 | 1.0V           | P3105Y<br>XATYW | SOT-89-3     | 1,000Units/Tape &Reel |
| PAM3105ACA120 | 1.2V           | P3105B<br>XATYW | SOT-89-3     | 1,000Units/Tape &Reel |
| PAM3105ACA150 | 1.5V           | P3105C<br>XATYW | SOT-89-3     | 1,000Units/Tape &Reel |
| PAM3105ACA180 | 1.8V           | P3105E<br>XATYW | SOT-89-3     | 1,000Units/Tape &Reel |
| PAM3105ACA250 | 2.5V           | P3105G<br>XATYW | SOT-89-3     | 1,000Units/Tape &Reel |
| PAM3105ACA280 | 2.8V           | P3105H<br>XATYW | SOT-89-3     | 1,000Units/Tape &Reel |
| PAM3105ACA285 | 2.85V          | P3105I<br>XATYW | SOT-89-3     | 1,000Units/Tape &Reel |
| PAM3105ACA300 | 3.0V           | P3105J<br>XATYW | SOT-89-3     | 1,000Units/Tape &Reel |
| PAM3105ACA330 | 3.3V           | P3105K<br>XATYW | SOT-89-3     | 1,000Units/Tape &Reel |

Please consult PAM sales office or authorized Rep. /Distributor for output voltage and package type availability.

### Outline Dimension

#### SOT-89-3

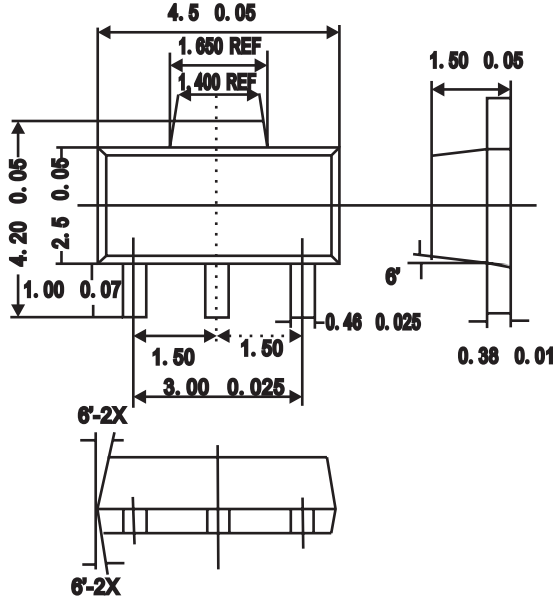

(Unit: mm)

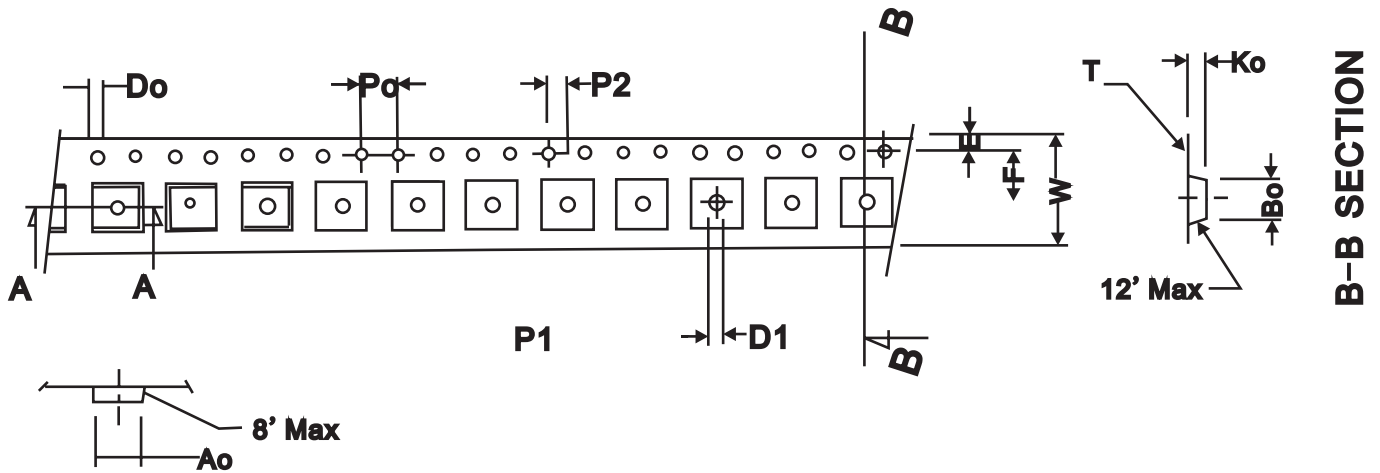

B-B SECTION

#### A-A SECTION

|        |          |          |           |          |                  |          |            |
|--------|----------|----------|-----------|----------|------------------|----------|------------|
| Symbol | Ao       | Bo       | Ko        | Po       | P1               | P2       | T          |
| Spec   | 4.85±0.1 | 4.45±0.1 | 1.85±0.1  | 4.0±0.1  | 8.0±0.10         | 2.0±0.05 | 0.254±0.02 |
| Symbol | E        | F        | Do        | D1       | W                | 10Po     |            |
| Spec   | 1.75±0.1 | 5.5±0.05 | 1.50±0.10 | 1.5±0.25 | 12.0+0.3<br>-0.1 | 40.0±0.2 |            |