

Aluminum Capacitors Solid Al, Radial Pearl Miniature

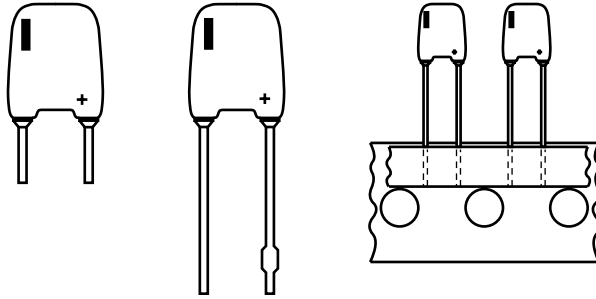
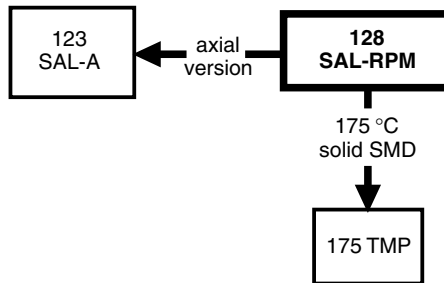

Fig.1 Component outlines



FEATURES

- Polarized aluminum electrolytic capacitors, solid electrolyte MnO₂
- Radial leads, max. height 10 mm, resin dipped, orange colored
- Extremely long useful life, 20 000 hours/125 °C
- Extended high temperature range up to 175 °C
- Excellent low temperature, impedance and ESR behaviour
- Charge and discharge proof, application with 0 Ω resistance allowed
- Reverse DC voltage up to 0.3 x U_R allowed
- AC voltage up to 0.8 x U_R allowed

**RoHS
COMPLIANT**

APPLICATIONS

- Audio-video, automotive, industrial high temperature and telecommunication
- Smoothing, filtering and buffering
- For small power supplies, DC/DC converters

MARKING

The capacitors are marked (where possible) with the following information:

- Rated capacitance (in μF)
- Tolerance on rated capacitance, code letter in accordance with IEC 60062 (M for ± 20 %)
- Rated voltage (in V) and category voltage if applicable
- Date code in accordance with IEC60062
- Name of manufacturer
- 'I' sign to indicate the negative terminal
- '+' sign to identify the positive terminal
- Series number

MOUNTING

When bending, cutting or straightening the leads, ensure that the capacitor body is relieved of stress.

Bending after soldering must be avoided.

QUICK REFERENCE DATA	
DESCRIPTION	VALUE
Maximum case sizes (H x W x T in mm)	10 x 7 x 3.5 to 10 x 8 x 6
Rated capacitance range (E6 series), C _R	0.22 μF to 68 μF
Tolerance on C _R	± 20 %
Rated voltage range, U _R	6.3 V to 40 V
Category temperature range: U _R = 6.3 to 40 V U _C = 6.3 to 25 V	- 55 °C to + 85 °C - 55 °C to + 125 °C
Endurance test at 125 °C	10 000 hours
Useful life at 125 °C	20 000 hours
Useful life at 175 °C	2000 hours
Useful life at 40 °C, I _R applied	> 300 000 hours
Shelf life at 0 V, 125 °C	500 hours
Based on sectional specification	IEC 60384-4/EN 130300
Climatic category IEC 60068	55/125/56

SELECTION CHART FOR C_R, U_R, U_C AND RELEVANT MAXIMUM CASE SIZES (H x W x T in mm)					
C_R (μF)	U_R (V) at $T_{amb} = 85^\circ C$				
	6.3	10	16	25	40
	U_C (V) at $T_{amb} = 125^\circ C$				
	6.3	10	16	25	25
0.22	-	-	-	-	10 x 7 x 3.5
0.33	-	-	-	-	10 x 7 x 4
0.47	-	-	-	-	10 x 7 x 5
0.68	-	-	-	10 x 7 x 3.5	10 x 7 x 5
1	-	-	-	10 x 7 x 3.5	10 x 7 x 5
1.5	-	-	-	10 x 7 x 3.5	10 x 8 x 6
2.2	-	-	10 x 7 x 3.5	10 x 7 x 4	10 x 8 x 6
3.3	-	-	10 x 7 x 3.5	10 x 7 x 5	-
4.7	-	10 x 7 x 3.5	10 x 7 x 4	10 x 8 x 5	-
6.8	-	10 x 7 x 3.5	10 x 7 x 4	10 x 8 x 5	-
10	10 x 7 x 3.5	10 x 7 x 4	10 x 7 x 5	10 x 8 x 6	-
15	-	10 x 7 x 4	10 x 8 x 5	-	-
22	10 x 7 x 4	10 x 7 x 5	10 x 8 x 6	-	-
33	10 x 7 x 5	10 x 8 x 5	-	-	-
47	10 x 8 x 5	10 x 8 x 6	-	-	-
68	10 x 8 x 6	-	-	-	-

DIMENSIONS in millimeters AND AVAILABLE FORMS

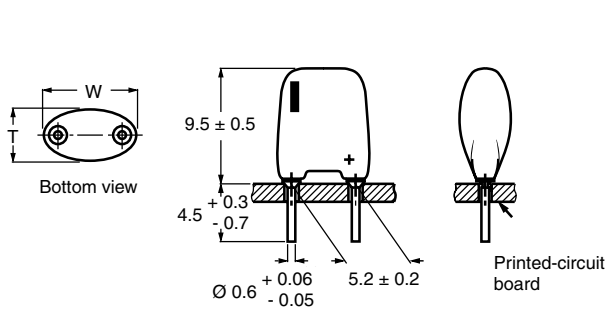

The diameter of the mounting holes in the printed-circuit board is 0.8 ± 0.1 mm. Flanges are provided with degassing grooves.

Fig.2 Form CB: Short leads, in boxes

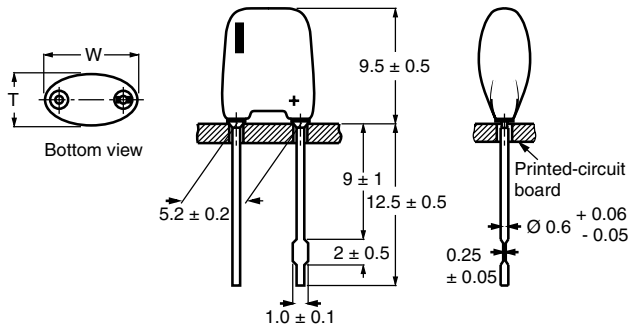

The diameter of the mounting holes in the printed-circuit board is 0.8 ± 0.1 mm, except for the hole of the anode lead of Form CA capacitors: 1.3 - 0.2 mm. Flanges are provided with degassing grooves.

Fig.3 Form CA: Long-leads with keyed polarity, in boxes

Table 1

DIMENSIONS in millimeters, MASS AND PACKAGING QUANTITIES							
MAXIMUM CASE SIZE H x W x T (mm)	CASE CODE	MASS (g)	PACKAGING QUANTITIES				
			FORM CA Note (1)	FORM CB Note (1)	FORM TR+	FORM TFA	
10 x 7 x 3.5	20	≈ 0.25	1000	1000	2000	1000	
10 x 7 x 4	30	≈ 0.30	1000	1000	2000	1000	
10 x 7 x 5	40	≈ 0.35	1000	1000	1000	1000	
10 x 8 x 5	50	≈ 0.50	1000	1000	1000	1000	
10 x 8 x 6	60	≈ 0.60	1000	1000	1000	1000	

Notes

(1) In plastic bags of 200 units each.

Detailed tape dimensions see section 'PACKAGING'.

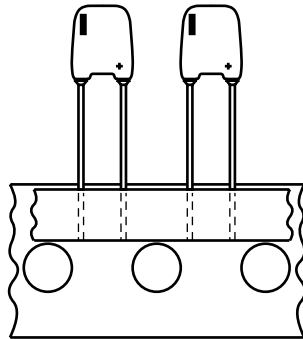
TAPED PRODUCTS

Form TR +: Taped on reel, positive leading
 Form TFA : Taped in ammpack

Fig.4 Taped versions

ELECTRICAL DATA	
C_R	rated capacitance at 100 Hz, tolerance $\pm 20\%$
I_R	max. RMS ripple current no necessary DC applied
I_{L5}	max. leakage current after 5 minutes at U_R
$\tan \delta$	max. dissipation factor at 100 Hz;
ESR	max./typ. equivalent series resistance at 100 Hz
Z	max. impedance at 100 kHz

Note

Unless otherwise specified, all electrical values in Table 2 apply at $T_{amb} = 20^\circ\text{C}$ to 25°C , $P = 86\text{ kPa}$ to 106 kPa , $RH = 45\%$ to 75% .

ORDERING EXAMPLE

Maximum case size: 10 x 7 x 5 mm; Form CB
 Electrolytic capacitors 128 series 10 $\mu\text{F}/16\text{ V}$; $\pm 20\%$

Ordering code: MAL212855109E3

Former 12NC: 2281 12855109

Table 2

ELECTRICAL DATA AND ORDERING INFORMATION														
U_C (V)	U_R (V)	C_R 100 Hz (μF)	MAXIMUM CASE SIZE H x W x T (mm)	I_R 100 Hz 125 °C (mA)	I_R 10 kHz 85 °C (mA)	I_R 100 kHz 40 °C (mA)	I_{L5} 5 min (μA)	MAX. ESR 100 Hz (Ω)	TYP. ESR 100 Hz (Ω)	Z 100 kHz (Ω)	ORDERING CODE MAL2128.....			
											FORM CB	FORM CA	FORM TR + REEL	FORM TFA AMMO
6.3	6.3	10	10 x 7 x 3.5	22.4	320	595	2	20	8	2.0	53109E3	73109E3	23109E3	33109E3
		22	10 x 7 x 4	32.9	470	870	4	9	3.5	1.0	53229E3	73229E3	23229E3	33229E3
		33	10 x 7 x 5	65.4	595	1100	5	6.1	2	0.70	53339E3	73339E3	23339E3	33339E3
		47	10 x 8 x 5	118.4	740	1360	7	4.3	2	0.50	53479E3	73479E3	23479E3	33479E3
		68	10 x 8 x 6	153.0	800	1650	11	3.0	1.5	0.40	53689E3	73689E3	23689E3	33689E3
10	10	4.7	10 x 7 x 3.5	16.1	230	425	2	43	16	3.00	54478E3	74478E3	24478E3	34478E3
		6.8	10 x 7 x 3.5	18.9	270	500	2	30	12	2.20	54688E3	74688E3	24688E3	34688E3
		10	10 x 7 x 4	21.7	310	573	3	20	9	1.70	54109E3	74109E3	24109E3	34109E3
		15	10 x 7 x 4	27.3	390	720	4	14	7	1.20	54159E3	74159E3	24159E3	34159E3
		22	10 x 7 x 5	51.7	470	870	6	9	3.5	0.90	54229E3	74229E3	24229E3	34229E3
		33	10 x 8 x 5	81.6	510	940	8	6.1	2	0.60	54339E3	74339E3	24339E3	34339E3
16	16	47	10 x 8 x 6	105.4	620	1140	12	4.3	1.5	0.40	54479E3	74479E3	24479E3	34479E3
		2.2	10 x 7 x 3.5	14.0	200	370	2	91	25	4.50	55228E3	75228E3	25228E3	35228E3
		3.3	10 x 7 x 3.5	16.1	230	425	2	61	26	3.30	55338E3	75338E3	25338E3	35338E3
		4.7	10 x 7 x 4	18.9	270	500	2	43	14	2.30	55478E3	75478E3	25478E3	35478E3
		6.8	10 x 7 x 4	22.4	320	590	3	30	11	1.65	55688E3	75688E3	25688E3	35688E3
		10	10 x 7 x 5	42.9	390	720	4	20	6	1.10	55109E3	75109E3	25109E3	35109E3
25	25	15	10 x 8 x 5	71.2	445	820	6	14	5	0.85	55159E3	75159E3	25159E3	35159E3
		22	10 x 8 x 6	86.7	510	940	9	9	3.5	0.65	55229E3	75229E3	25229E3	35229E3
		0.68	10 x 7 x 3.5	7.7	110	200	2	295	85	17.00	56687E3	76687E3	26687E3	36687E3
		1	10 x 7 x 3.5	9.1	130	240	2	200	71	12.50	56108E3	76108E3	26108E3	36108E3
		1.5	10 x 7 x 3.5	10.8	155	285	2	135	48	10.00	56158E3	76158E3	26158E3	36158E3
		2.2	10 x 7 x 4	13.6	195	360	2	91	34	7.00	56228E3	76228E3	26228E3	36228E3
		3.3	10 x 7 x 5	16.1	230	425	2	61	19	5.20	56338E3	76338E3	26338E3	36338E3
		4.7	10 x 8 x 5	25.3	270	500	3	43	14	3.50	56478E3	76478E3	26478E3	36478E3
25	40	6.8	10 x 8 x 6	52.7	310	570	4	30	11	2.70	56688E3	76688E3	26688E3	36688E3
		10	10 x 8 x 6	64.8	360	660	6	20	9	2.00	56109E3	76109E3	26109E3	36109E3
		0.22	10 x 7 x 3.5	4.2	60	115	2	910	275	27.00	57227E3	77227E3	27227E3	37227E3
		0.33	10 x 7 x 4	5.3	75	140	2	610	172	20.00	57337E3	77337E3	27337E3	37337E3
		0.47	10 x 7 x 5	10.4	95	175	2	430	114	15.00	57477E3	77477E3	27477E3	37477E3
		0.68	10 x 7 x 5	12.1	110	205	2	295	89	10.00	57687E3	77687E3	27687E3	37687E3
25	40	1	10 x 8 x 5	20.0	125	230	2	200	45	7.00	57108E3	77108E3	27108E3	37108E3
		1.5	10 x 8 x 6	25.5	150	280	2	135	35	5.50	57158E3	77158E3	27158E3	37158E3
		2.2	10 x 8 x 6	33.1	195	360	2	91	28	4.20	57228E3	77228E3	27228E3	37228E3

Note

 1. $\tan \delta$ at 100 Hz for all types < 0.10



ADDITIONAL ELECTRICAL DATA		
PARAMETER	CONDITIONS	VALUE
Voltage		
Surge voltage		$U_s \leq 1.15 \times U_R$
Reverse voltage		$U_{rev} < 0.3 \times U_R$
Maximum peak AC voltage	Reverse voltage applied	$\leq 2 \text{ V}$
Maximum peak AC voltage, without reverse voltage applied	$T_{amb} \leq 85 \text{ }^\circ\text{C}$:	
	at $f \leq 0.1 \text{ Hz}$ at $0.1 \text{ Hz} < f \leq 1 \text{ Hz}$ at $1 \text{ Hz} < f \leq 10 \text{ Hz}$ at $10 \text{ Hz} < f \leq 50 \text{ Hz}$ at $f > 50 \text{ Hz}$	$0.30 \times U_R$ $0.45 \times U_R$ $0.60 \times U_R$ $0.65 \times U_R$ $0.80 \times U_R$
	$85 \text{ }^\circ\text{C} < T_{amb} \leq 125 \text{ }^\circ\text{C}$:	
	at $f \leq 0.1 \text{ Hz}$ at $0.1 \text{ Hz} < f \leq 1 \text{ Hz}$ at $1 \text{ Hz} < f \leq 10 \text{ Hz}$ at $10 \text{ Hz} < f \leq 50 \text{ Hz}$ at $f > 50 \text{ Hz}$	$0.15 \times U_R$ $0.22 \times U_R$ $0.30 \times U_R$ $0.32 \times U_R$ $0.40 \times U_R$
Inductance		
Equivalent series inductance (ESL)	Case sizes 10 x 7 x 3.5 mm to 10 x 7 x 5 mm	typ. 9 nH to 14 nH
	Case sizes 10 x 8 x 5 mm and 10 x 8 x 6 mm	typ. 11 nH to 16 nH
	All case sizes	max. 20 nH
Dissipation		
Maximum power dissipation	Case sizes 10 x 7 x 3.5 mm to 10 x 7 x 5 mm	$P_{125} = 88 \text{ mW}$
	Case sizes 10 x 8 x 5 mm and 10 x 8 x 6 mm	$P_{125} = 104 \text{ mW}$
Current		
Maximum leakage current	After 5 minutes at U_R and $T_{amb} = 25 \text{ }^\circ\text{C}$	$I_{L5} \leq 0.025 C_R \times U_R$ or $2 \text{ } \mu\text{A}$ whichever is greater; see Table 2
Typical leakage current	15 s at U_R and $T_{amb} = 25 \text{ }^\circ\text{C}$:	
	$U_R = 6.3$ to 16 V $U_R = 25$ to 40 V	$\approx 0.2 \times$ value stated in Table 2 $\approx 0.1 \times$ value stated in Table 2

VOLTAGE

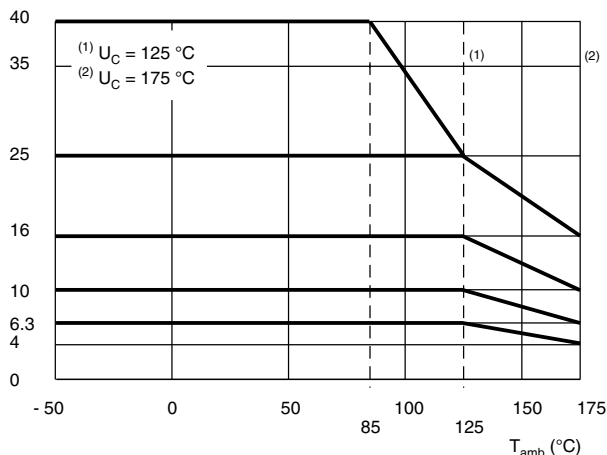

Fig.5 Maximum permissible voltage up to $T_{amb} = 175 \text{ }^\circ\text{C}$

RIPPLE CURRENT (I_R)

PARAMETER	T_{amb}					
	25 °C	40 °C	65 °C	85 °C	105 °C	125 °C
I_R multiplier	1.1	1.0	0.88	0.75	0.59	0.37

Notes

- Applying the maximum RMS ripple current given in Table 2 will cause a device temperature of $138 \text{ }^\circ\text{C}$
- The 100 kHz values in Table 2 for other temperatures are to be calculated with the above I_R multipliers:



CAPACITANCE (C)

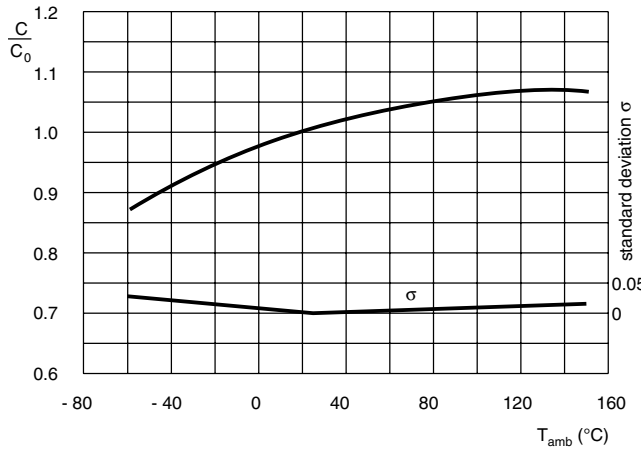

Fig.6 Typical multiplier of capacitance and standard deviation as functions of ambient temperature

TYPICAL CAPACITANCE CHANGE AFTER ENDURANCE TEST AT $T_{AMB} = 125\text{ }^{\circ}\text{C}$

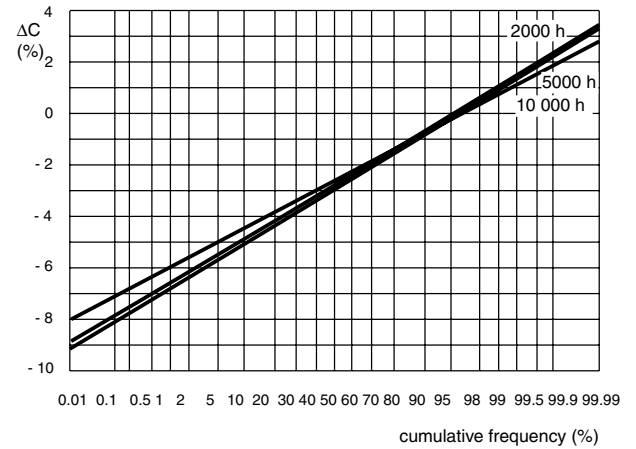
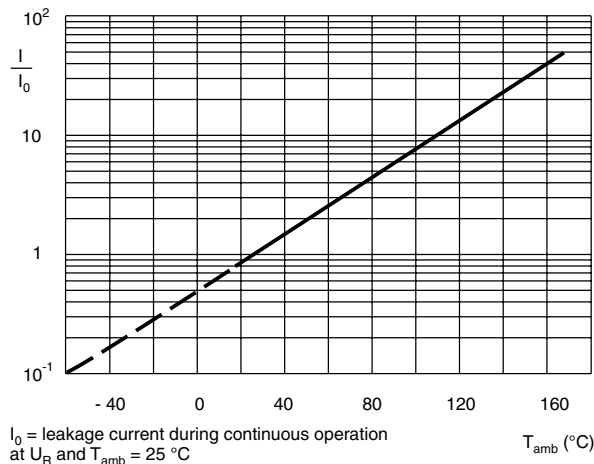

Fig.7 Change of capacitance as a function of cumulative frequency after endurance test

LEAKAGE CURRENT



I_0 = leakage current during continuous operation at U_R and $T_{amb} = 25\text{ }^{\circ}\text{C}$

Fig.8 Typical multiplier of leakage current as a function of ambient temperature

TYPICAL LEAKAGE CURRENT CHANGE AFTER ENDURANCE TEST AT $T_{AMB} = 125\text{ }^{\circ}\text{C}$

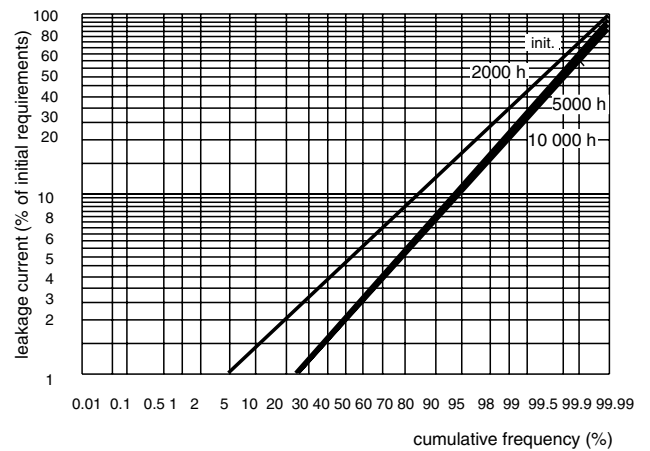
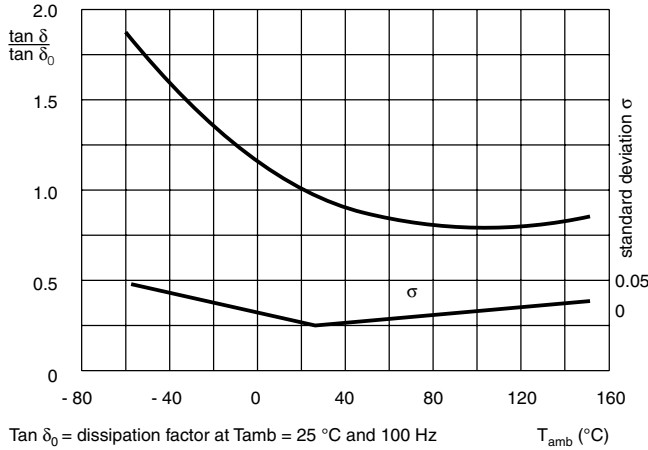

Fig.9 Change of leakage current as a function of cumulative frequency after endurance test

DISSIPATION FACTOR ($\tan \delta$)



$\tan \delta_0$ = dissipation factor at $T_{amb} = 25^\circ\text{C}$ and 100 Hz T_{amb} ($^\circ\text{C}$)

Fig.10 Typical multiplier of dissipation factor and standard deviation as functions of ambient temperature

TYPICAL $\tan \delta$ CHANGE AFTER ENDURANCE TEST AT $T_{amb} = 125^\circ\text{C}$

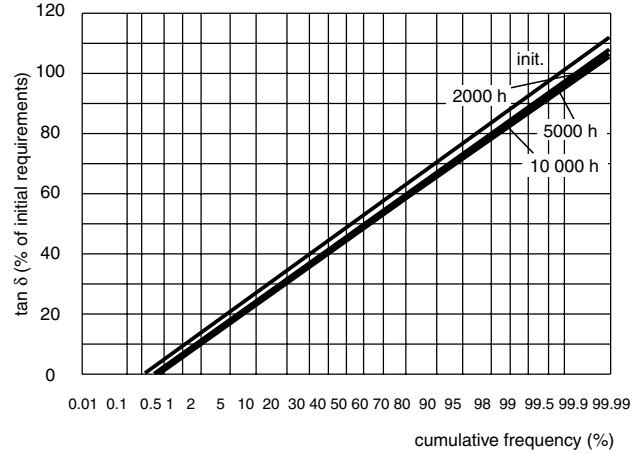

Fig.11 $\tan \delta$ change of capacitance as a function of cumulative frequency after endurance test

EQUIVALENT SERIES RESISTANCE (ESR)

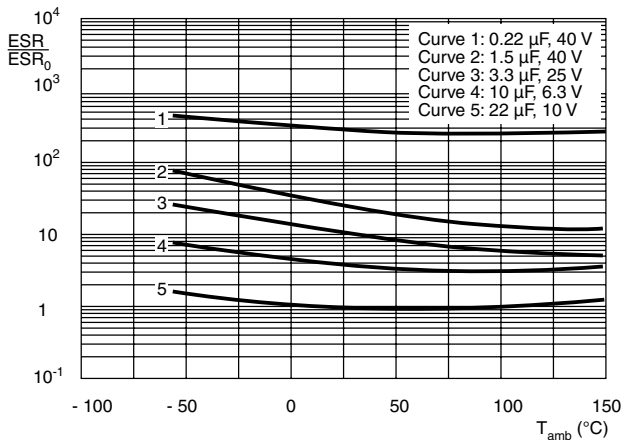

Fig.12 Typical multiplier of ESR at 100 Hz as a function of ambient temperature

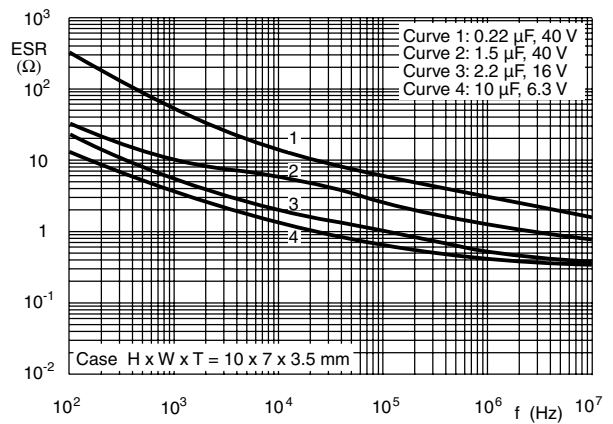

Fig.13 Typical ESR at 25°C as a function of frequency

EQUIVALENT SERIES RESISTANCE (ESR)

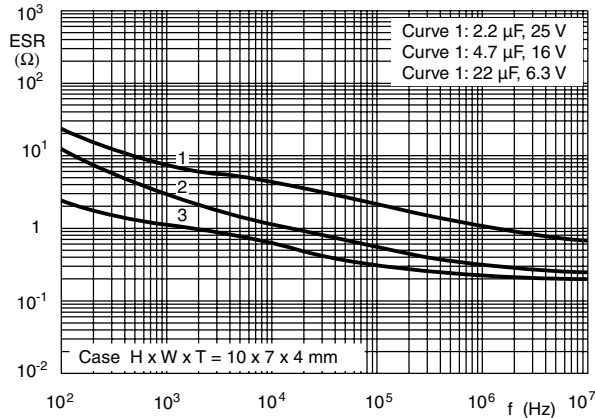

Fig.14 Typical ESR at 25 °C as a function of frequency

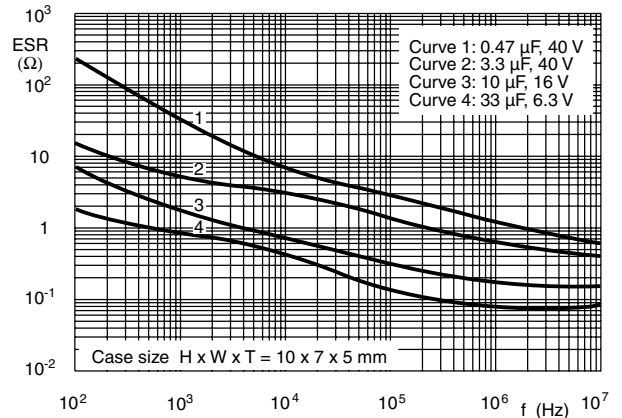

Fig.15 Typical ESR at 25 °C as a function of frequency

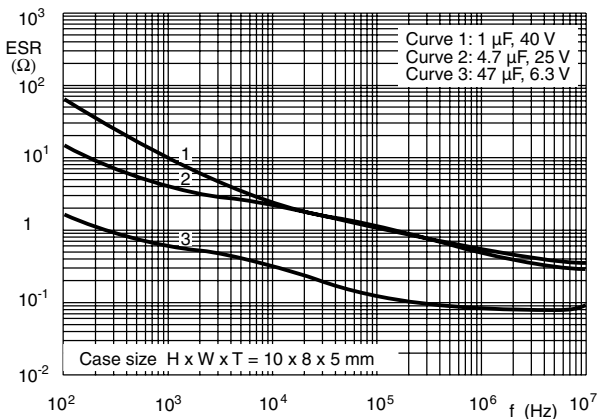

Fig.16 Typical ESR as a function of frequency

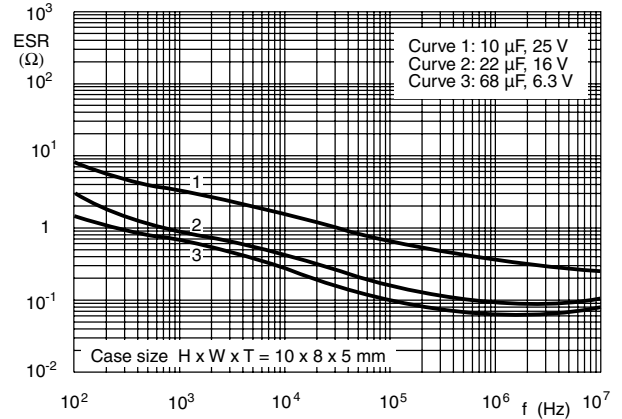

Fig.17 Typical ESR at 25 °C as a function of frequency

IMPEDANCE (Z)

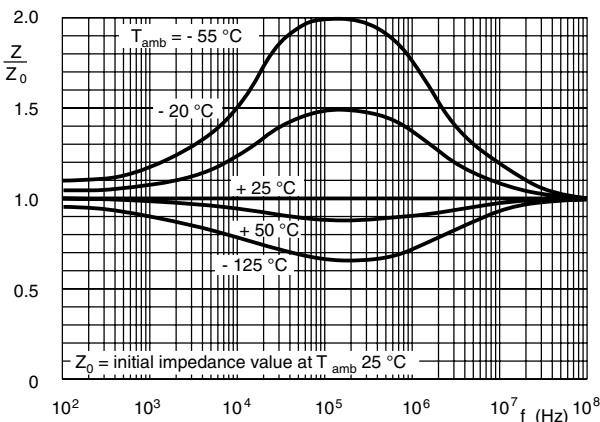

Fig.18 Typical multiplier of impedance as a function of frequency at different ambient temperatures

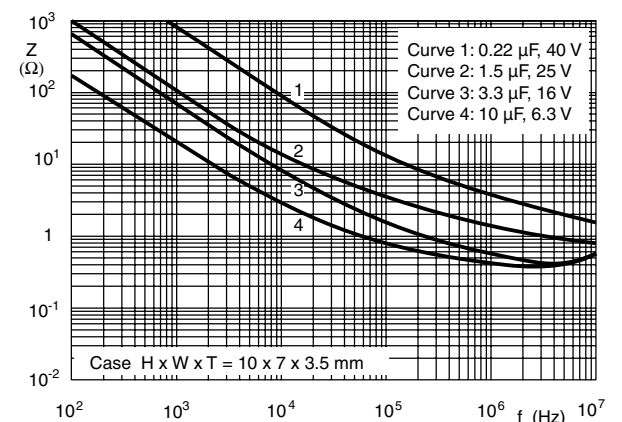

Fig.19 Typical impedance at 25 °C as a function of frequency

IMPEDANCE (Z)

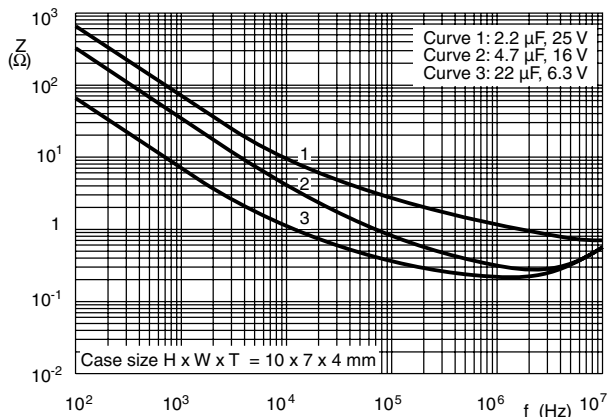

Fig.20 Typical impedance at 25 °C as a function of frequency

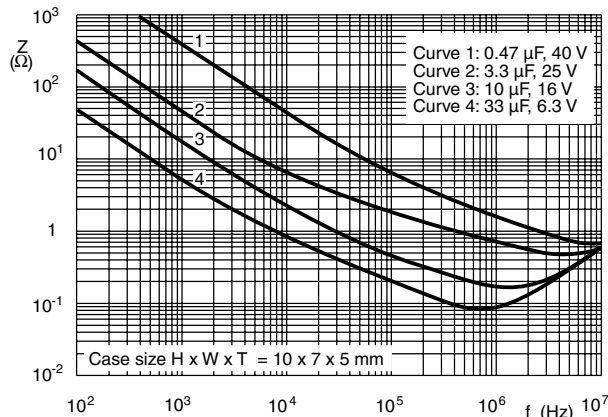

Fig.21 Typical impedance at 25 °C as a function of frequency

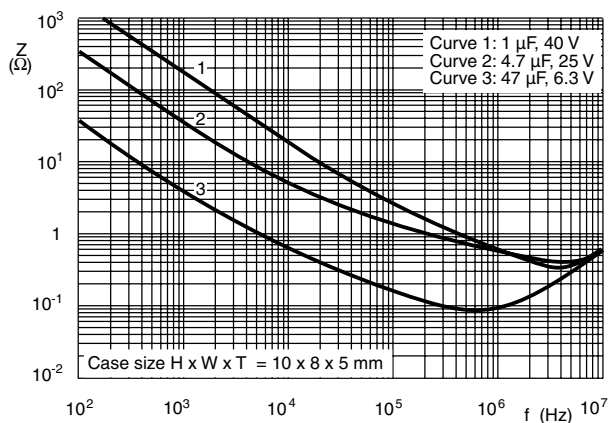

Fig.22 Typical impedance at 25 °C as a function of frequency

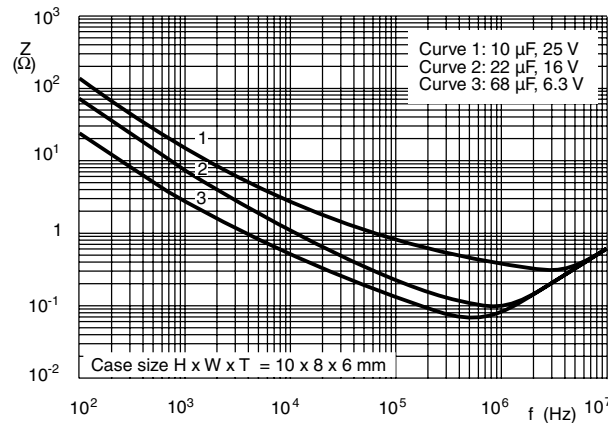

Fig.23 Typical impedance at 25 °C as a function of frequency

Table 3

TEST PROCEDURES AND REQUIREMENTS			
TEST		PROCEDURE (quick reference)	REQUIREMENTS
NAME OF TEST	REFERENCE		
Endurance	IEC 60384-4/ EN130300 subclause 4.13	$T_{amb} = 125\text{ }^{\circ}\text{C}$; $U_R = 6.3\text{ V}$ to 25 V with U_R applied; $U_R = 40\text{ V}$ with U_C applied; 10 000 hours	$\Delta C/C: \pm 10\%$ $\tan \delta \leq 1.2 \times \text{spec. limit}$ $Z \leq 1.2 \times \text{spec. limit}$ $I_{L5} \leq \text{spec. limit}$
Useful life	CECC 30302 subclause 1.8.1	$T_{amb} = 125\text{ }^{\circ}\text{C}$; I_R applied and: $U_R = 6.3\text{ V}$ to 25 V with U_R applied; $U_R = 40\text{ V}$ with U_C applied; 20 000 hours	$\Delta C/C: \pm 15\%$ $\tan \delta \leq 1.5 \times \text{spec. limit}$ $Z \leq 1.5 \times \text{spec. limit}$ $I_{L5} \leq \text{spec. limit}$ no short or open circuit, no visible damage total failure percentage: $< 1\%$
Shelf life (storage at high temperature)	IEC 60384-4/ EN130300 subclause 4.17	$T_{amb} = 125\text{ }^{\circ}\text{C}$; no voltage applied; 500 hours	$\Delta C/C: \pm 10\%$ $\tan \delta \leq 1.2 \times \text{spec. limit}$ $I_{L5} \leq \text{spec. limit}$
Charge and discharge	IEC 60384-4-2 subclause 9.21	10^6 cycles without series resistance: 0.5 s to U_R ; 0.5 s to ground	$\Delta C/C: \pm 5\%$ no short or open circuit, no visible damage
Solvent resistance	IEC 60068-2-45, test XA IEC 60653	immersion: 5 min \pm 0.5 min with or without ultrasonic at $55\text{ }^{\circ}\text{C} \pm 5\text{ }^{\circ}\text{C}$ solvents: demineralized water and/or calgonite solution (20 g/l)	visual appearance not affected
Extended vibration	IEC 60068-2-6 test Fc	10 Hz to 2000 Hz; 1.5 mm or 20 g; 1 octave/min; 3 directions; 1 sweep per direction; no voltage applied	no intermittent contacts no breakdown no open circuiting no mechanical damage $\Delta C/C: \pm 5\%$ $\tan \delta \leq 1.2 \times \text{spec. limit}$ $Z \leq 1.2 \times \text{spec. limit}$ $I_{L5} \leq 1.5 \times \text{spec. limit}$
Shock	IEC 60068-2-27 test Ea	half-sine or sawtooth pulse shape; 50 g; 11 ms; 3 successive shocks in each direction of 3 mutually perpendicular axes; no voltage applied	no intermittent contacts no breakdown no open circuiting no mechanical damage $\Delta C/C: \pm 5\%$ $\tan \delta \leq 1.2 \times \text{spec. limit}$ $Z \leq 1.2 \times \text{spec. limit}$ $I_{L5} \leq 1.5 \times \text{spec. limit}$
Passive flammability	IEC 60695-2-2	capacitor mounted to a vertical printed-circuit board, one flame on capacitor body; $T_{amb} = 20\text{ }^{\circ}\text{C}$ to $25\text{ }^{\circ}\text{C}$; test duration = 20 s	after removing the test flame from the capacitor, the capacitor must not continue to burn for more than 15 s; no burning particles must drop from the sample



Disclaimer

All product specifications and data are subject to change without notice.

Vishay Intertechnology, Inc., its affiliates, agents, and employees, and all persons acting on its or their behalf (collectively, "Vishay"), disclaim any and all liability for any errors, inaccuracies or incompleteness contained herein or in any other disclosure relating to any product.

Vishay disclaims any and all liability arising out of the use or application of any product described herein or of any information provided herein to the maximum extent permitted by law. The product specifications do not expand or otherwise modify Vishay's terms and conditions of purchase, including but not limited to the warranty expressed therein, which apply to these products.

No license, express or implied, by estoppel or otherwise, to any intellectual property rights is granted by this document or by any conduct of Vishay.

The products shown herein are not designed for use in medical, life-saving, or life-sustaining applications unless otherwise expressly indicated. Customers using or selling Vishay products not expressly indicated for use in such applications do so entirely at their own risk and agree to fully indemnify Vishay for any damages arising or resulting from such use or sale. Please contact authorized Vishay personnel to obtain written terms and conditions regarding products designed for such applications.

Product names and markings noted herein may be trademarks of their respective owners.