

To all our customers

Regarding the change of names mentioned in the document, such as Mitsubishi Electric and Mitsubishi XX, to Renesas Technology Corp.

The semiconductor operations of Hitachi and Mitsubishi Electric were transferred to Renesas Technology Corporation on April 1st 2003. These operations include microcomputer, logic, analog and discrete devices, and memory chips other than DRAMs (flash memory, SRAMs etc.) Accordingly, although Mitsubishi Electric, Mitsubishi Electric Corporation, Mitsubishi Semiconductors, and other Mitsubishi brand names are mentioned in the document, these names have in fact all been changed to Renesas Technology Corp. Thank you for your understanding. Except for our corporate trademark, logo and corporate statement, no changes whatsoever have been made to the contents of the document, and these changes do not constitute any alteration to the contents of the document itself.

Note : Mitsubishi Electric will continue the business operations of high frequency & optical devices and power devices.

Renesas Technology Corp.
Customer Support Dept.
April 1, 2003

PRELIMINARY
 Notice: This is not a final specification.
 Some parametric limits are subject to change.

MITSUBISHI POWER MOSFET

FL20KM-5A

HIGH-SPEED SWITCHING USE
 Nch POWER MOSFET

FL20KM-5A



- 10V DRIVE
- V_{DSS} 250V
- r_{DS (ON)} (MAX) 0.19Ω
- I_D 20A
- V_{iso} 2000V

OUTLINE DRAWING

Dimensions in mm

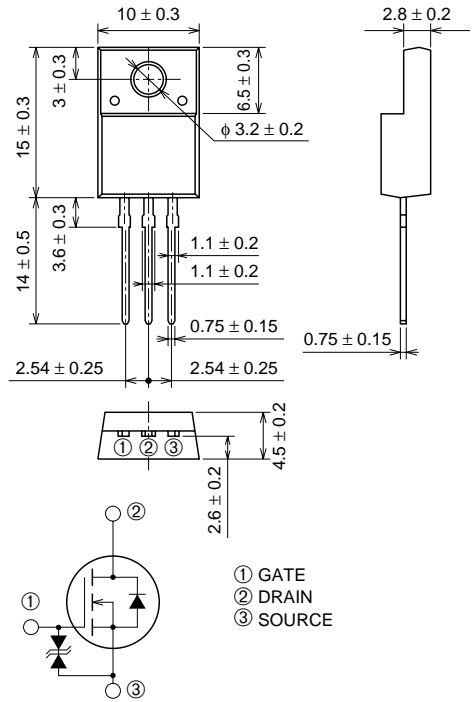

TO-220FN

APPLICATION

Inverter type fluorescent light sets, SMPS

MAXIMUM RATINGS (T_c = 25°C)

Symbol	Parameter	Conditions	Ratings	Unit
V _{DSS}	Drain-source voltage	V _{GS} = 0V	250	V
V _{GSS}	Gate-source voltage	V _{DS} = 0V	±30	V
I _D	Drain current		20	A
I _{DM}	Drain current (Pulsed)		60	A
I _{DA}	Avalanche current (Pulsed)	L = 200μH	20	A
P _D	Maximum power dissipation		35	W
T _{ch}	Channel temperature		-55 ~ +150	°C
T _{stg}	Storage temperature		-55 ~ +150	°C
V _{iso}	Isolation voltage	AC for 1minute, Terminal to case	2000	V
—	Weight	Typical value	2.0	g

Aug. 1999

FL20KM-5A

HIGH-SPEED SWITCHING USE
Nch POWER MOSFET

PRELIMINARY
Notice: This is not a final specification.
Some parametric limits are subject to change.

ELECTRICAL CHARACTERISTICS (Tch = 25°C)

Symbol	Parameter	Test conditions	Limits			Unit
			Min.	Typ.	Max.	
V (BR) DSS	Drain-source breakdown voltage	Id = 1mA, VGS = 0V	250	—	—	V
V (BR) GSS	Gate-source breakdown voltage	IGS = ±100μA, VDS = 0V	±30	—	—	V
IGSS	Gate-source leakage current	VGS = ±30V, VDS = 0V	—	—	±10	μA
IDSS	Drain-source leakage current	VDS = 250V, VGS = 0V	—	—	1.0	mA
VGS (th)	Gate-source threshold voltage	Id = 1mA, VDS = 10V	2.0	3.0	4.0	V
rDS (ON)	Drain-source on-state resistance	Id = 10A, VGS = 10V	—	0.15	0.19	Ω
VDS (ON)	Drain-source on-state voltage	Id = 10A, VGS = 10V	—	1.50	1.90	V
yfs	Forward transfer admittance	Id = 10A, VDS = 10V	—	12	—	S
Ciss	Input capacitance	VDS = 25V, VGS = 0V, f = 1MHz	—	1300	—	pF
Coss	Output capacitance		—	250	—	pF
Crss	Reverse transfer capacitance		—	40	—	pF
td (on)	Turn-on delay time	VDD = 150V, Id = 10A, VGS = 10V, RGEN = RGS = 50Ω	—	25	—	ns
tr	Rise time		—	50	—	ns
td (off)	Turn-off delay time		—	200	—	ns
tf	Fall time		—	80	—	ns
VSD	Source-drain voltage	IS = 10A, VGS = 0V	—	1.5	2.0	V
Rth (ch-c)	Thermal resistance	Channel to case	—	—	3.57	°C/W
Trr	Reverse recovery time	IS = 20A, VGS = 0V, dis/dt = -100A/μs	—	300	—	ns

PERFORMANCE CURVES

POWER DISSIPATION DERATING CURVE

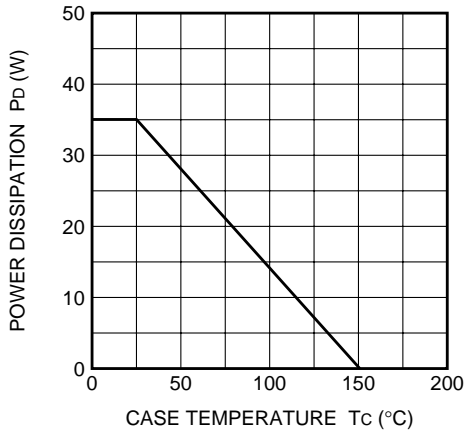

MAXIMUM SAFE OPERATING AREA

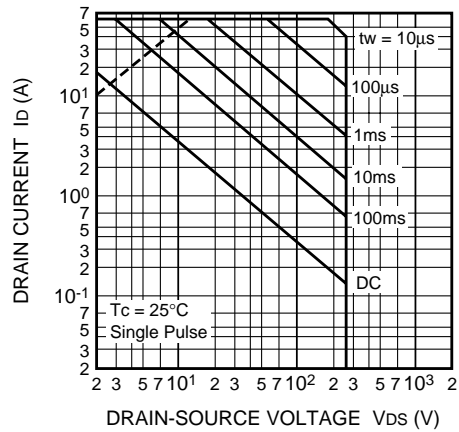

OUTPUT CHARACTERISTICS (TYPICAL)

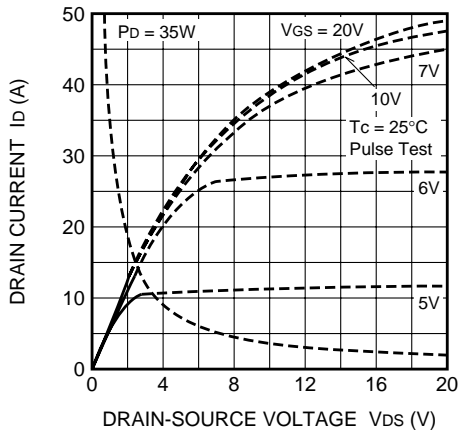

OUTPUT CHARACTERISTICS (TYPICAL)

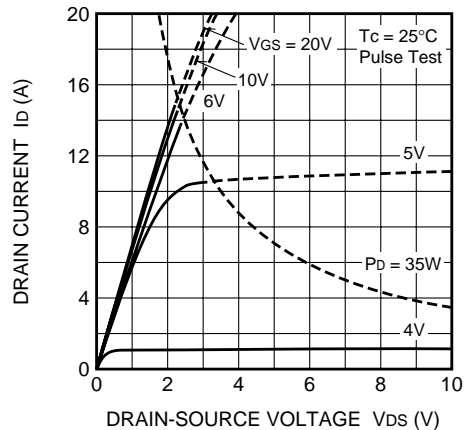

PRELIMINARY
 Notice: This is not a final specification.
 Some parametric limits are subject to change.

FL20KM-5A

HIGH-SPEED SWITCHING USE
 Nch POWER MOSFET

ON-STATE VOLTAGE VS. GATE-SOURCE VOLTAGE (TYPICAL)

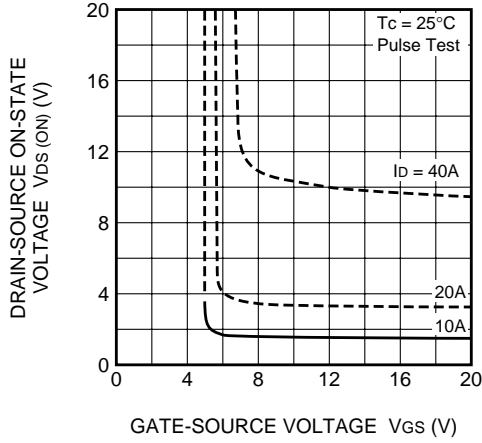

ON-STATE RESISTANCE VS. DRAIN CURRENT (TYPICAL)

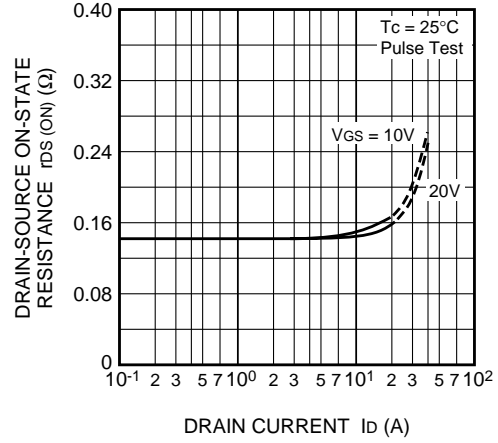

TRANSFER CHARACTERISTICS (TYPICAL)

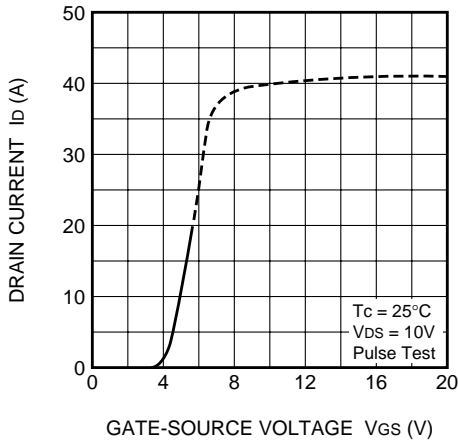

FORWARD TRANSFER ADMITTANCE VS. DRAIN CURRENT (TYPICAL)

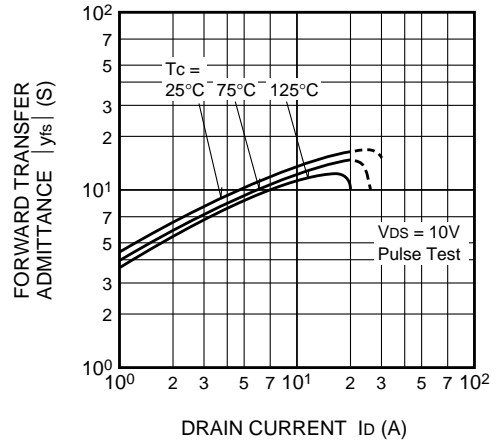

CAPACITANCE VS. DRAIN-SOURCE VOLTAGE (TYPICAL)

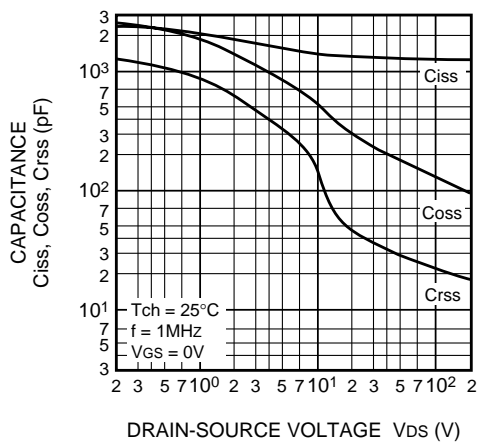

SWITCHING CHARACTERISTICS (TYPICAL)

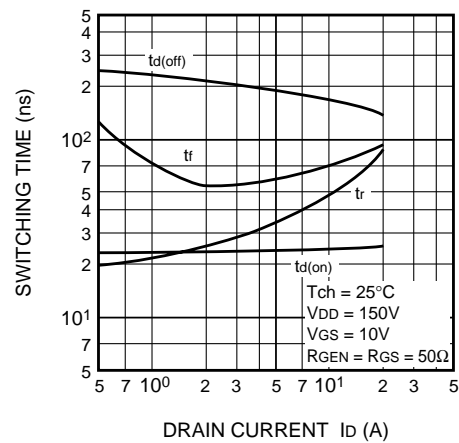

PRELIMINARY
 Notice: This is not a final specification.
 Some parametric limits are subject to change.

FL20KM-5A

HIGH-SPEED SWITCHING USE
 Nch POWER MOSFET

GATE-SOURCE VOLTAGE VS. GATE CHARGE (TYPICAL)

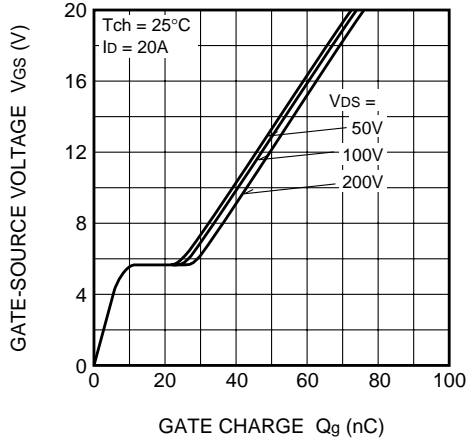

SOURCE-DRAIN DIODE FORWARD CHARACTERISTICS (TYPICAL)

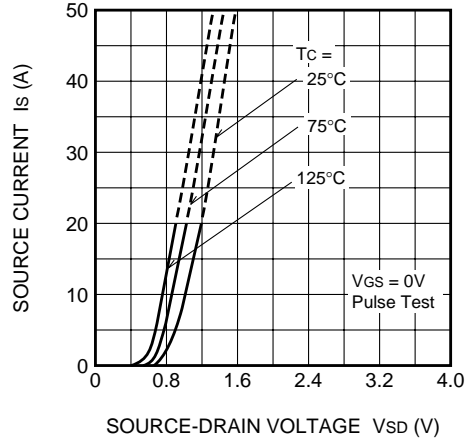

ON-STATE RESISTANCE VS. CHANNEL TEMPERATURE (TYPICAL)

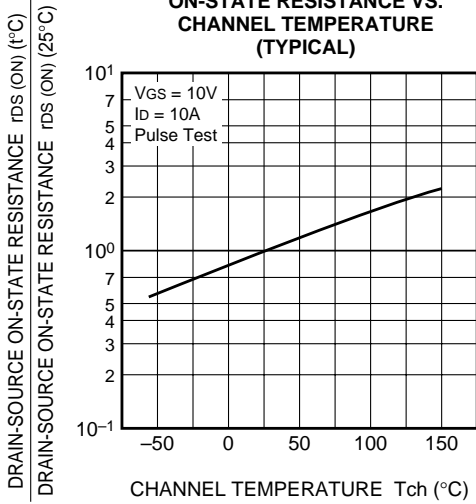

THRESHOLD VOLTAGE VS. CHANNEL TEMPERATURE (TYPICAL)

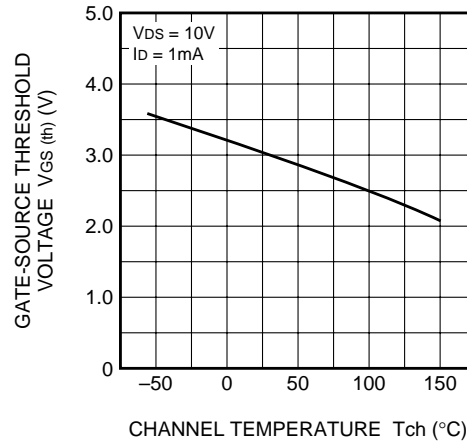

BREAKDOWN VOLTAGE VS. CHANNEL TEMPERATURE (TYPICAL)

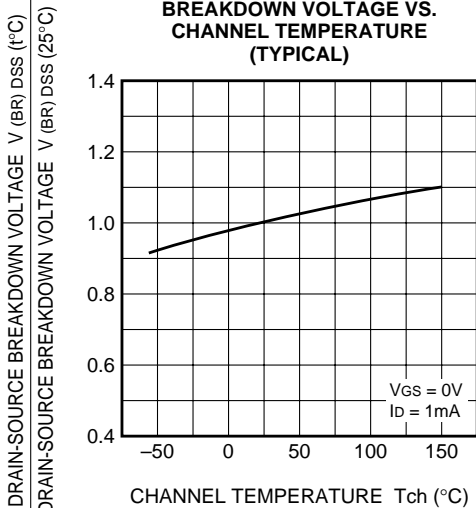

TRANSIENT THERMAL IMPEDANCE CHARACTERISTICS

