



ESDAVLC6V1-1BM2, ESDAVLC6V1-1BT2

Single line low capacitance Transil™ for ESD protection

Features

- Single line bi-directional protection
- Breakdown voltage $V_{BR} = 6.1 \text{ V min.}$
- Very low capacitance (6 pF typ. @ 3 V)
- Lead-free package

Benefits

- Very low capacitance for optimized data integrity
- Very low reverse current $< 0.1 \mu\text{A}$
- Low PCB space consumption: $0.6 \text{ mm}^2 \text{ max}$
- High reliability offered by monolithic integration

Complies with the following standards:

- IEC 61000-4-2 level 4
 - 15 kV (air discharge)
 - 8 kV (contact discharge)
- MIL STD 883G - Method 3015-7: class 3 B
 - Human body model

Applications

Where transient overvoltage protection in ESD sensitive equipment is required, such as:

- Computers
- Printers
- Communication systems
- Cellular phone handsets and accessories
- Video equipment

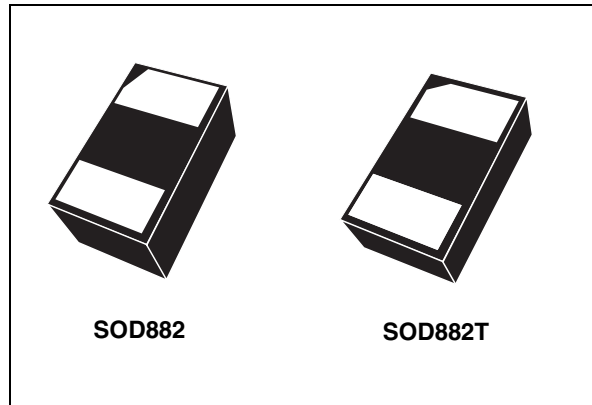
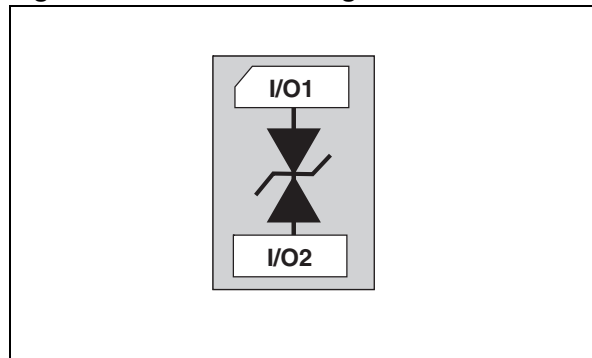

Figure 1. Functional diagram



Description

The ESDAVLC6V1-1BM2 and ESDAVLC6V1-1BT2 are monolithic application specific devices dedicated to ESD protection of high speed serial interfaces such as USB 2.0, display and camera interface.

The devices are ideal for applications where both printed circuit board space and power absorption capability are required.

TM: Transil is a trademark of STMicroelectronics

1 Characteristics

Table 1. Absolute maximum ratings ($T_{amb} = 25^{\circ} C$)

Symbol	Parameter		Value	Unit
$V_{PP}^{(1)}$	Peak pulse voltage	IEC 61000-4-2 contact discharge	15	kV
		IEC 61000-4-2 air discharge	15	
		MIL STD 883G - Method 3015-7: class 3B	25	
$P_{PP}^{(1)}$	Peak pulse power dissipation (8/20 μ s)	T_j initial = T_{amb}	30	W
I_{PP}	Peak pulse current (8/20 μ s)		2.5	A
T_j	Junction temperature		125	$^{\circ}C$
T_{stg}	Storage temperature range		- 55 to + 150	$^{\circ}C$
T_L	Maximum lead temperature for soldering during 10 s		260	$^{\circ}C$
T_{OP}	Operating temperature range		- 40 to + 125	$^{\circ}C$

1. For a surge greater than the maximum values, the diode will fail in short-circuit.

Table 2. Electrical characteristics ($T_{amb} = 25^{\circ} C$)

Symbol	Parameter				
V_{RM}	Stand-of voltage				
V_{BR}	Breakdown voltage				
V_{CL}	Clamping voltage				
I_{RM}	Leakage current @ V_{RM}				
I_{PP}	Peak pulse current				
Parameter	Test condition	Min	Typ	Max	Unit
V_{BR}	$I_R = 1 \text{ mA}$	6.1			V
I_{RM}	$V_{RM} = 3 \text{ V}$			100	nA
R_d			1.6		Ω
αT				2.5	$10^{-4}/^{\circ}C$
C	F = 1 MHz, $V_R = 0 \text{ V}$		7	8	pF
	F = 1 MHz, $V_R = 3 \text{ V}$		6	7	

Figure 2. Relative variation of peak pulse power versus initial junction temperature

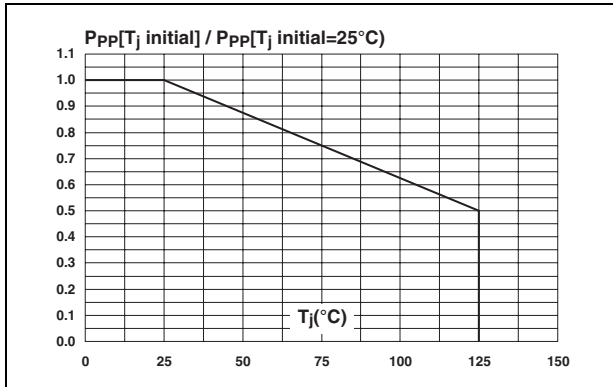

Figure 3. Peak pulse power versus exponential pulse duration

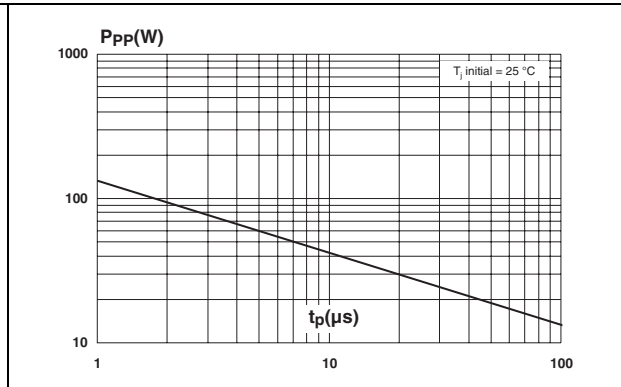

Figure 4. Clamping voltage versus peak pulse current (typical values)

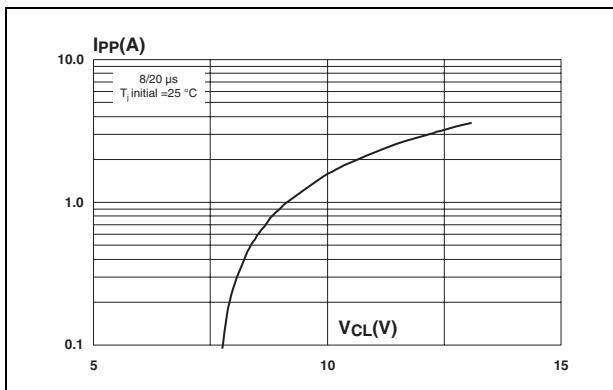

Figure 5. Junction capacitance versus reverse voltage applied (typical values)

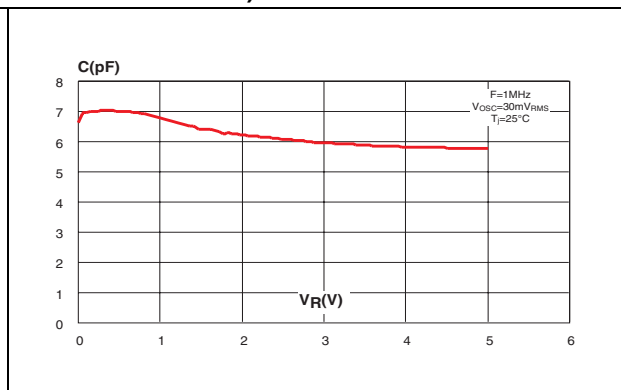

Figure 6. Relative variation of leakage current versus junction temperature (typical values)

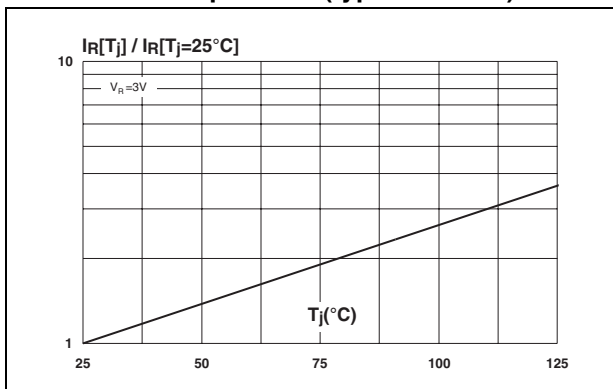

Figure 7. S21 attenuation measurement result

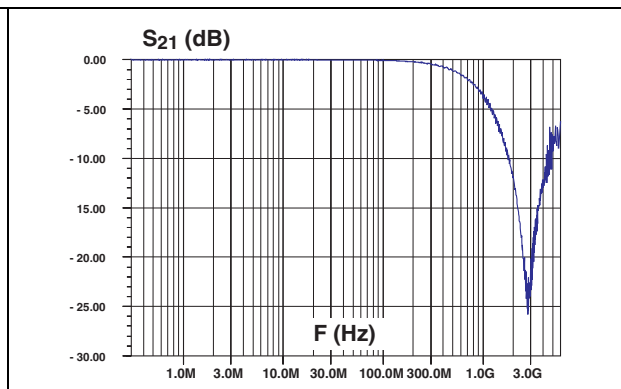

Figure 8. ESD response to IEC 61000-4-2 (+2 kV air discharge)

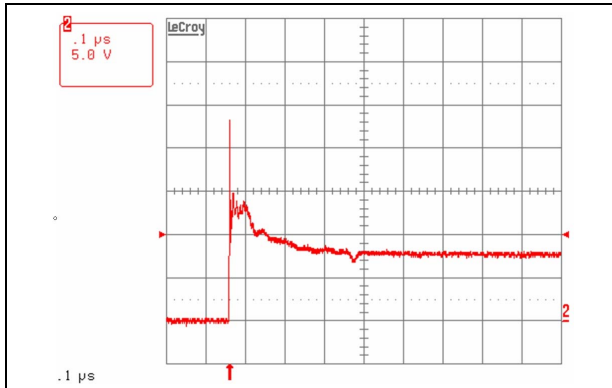

Figure 9. ESD response to IEC 61000-4-2 (-2 kV air discharge)

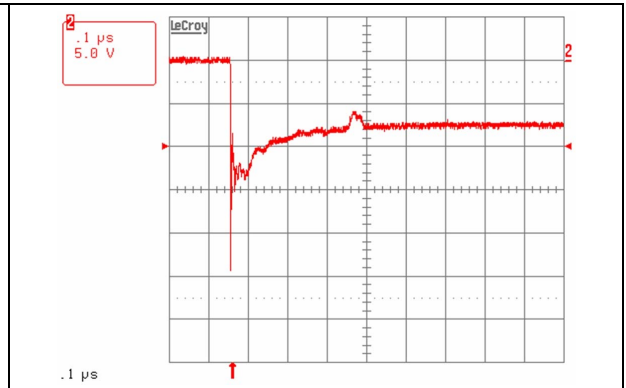

Figure 10. ESD response to IEC 61000-4-2 (+8 kV air discharge)

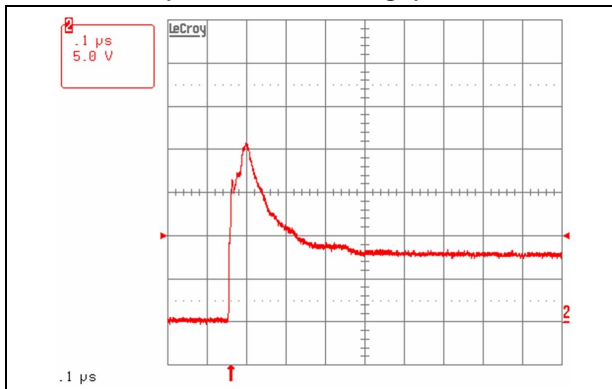

Figure 11. ESD response to IEC 61000-4-2 (-8 kV air discharge)

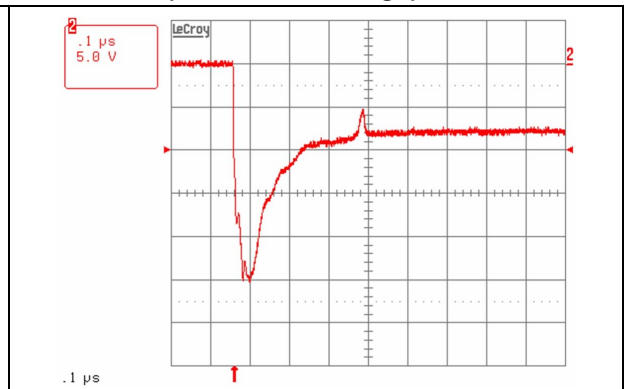

Figure 12. ESD response to IEC 61000-4-2 (+15 kV air discharge)

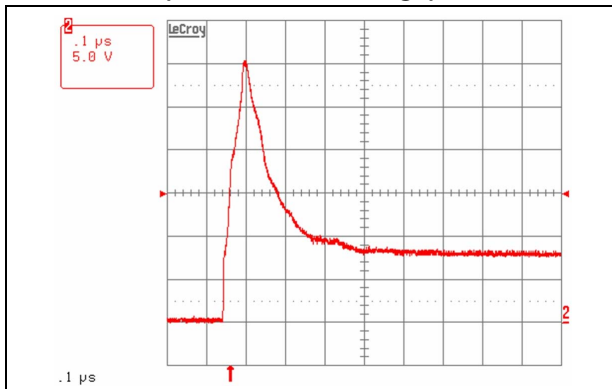

Figure 13. ESD response to IEC 61000-4-2 (-15 kV air discharge)

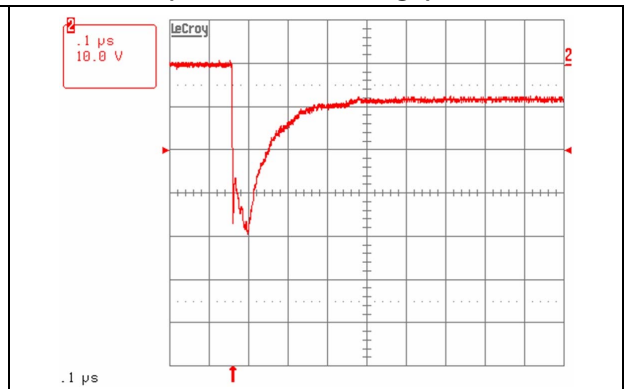

Figure 14. ESD response to IEC 61000-4-2 (+2 kV contact discharge)

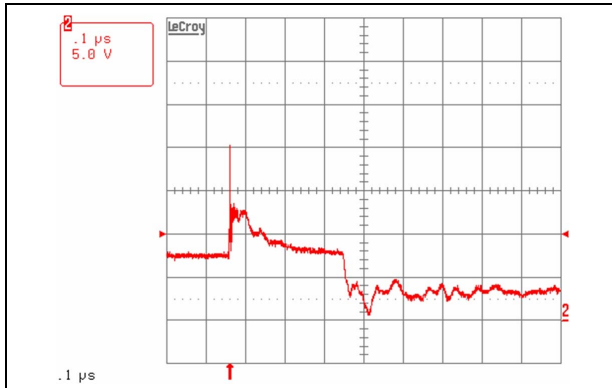

Figure 15. ESD response to IEC 61000-4-2 (-2 kV contact discharge)

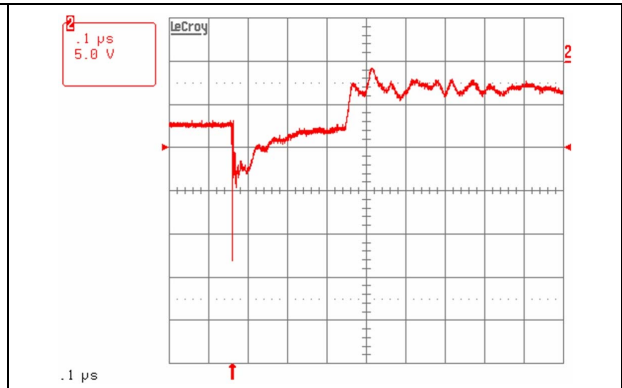

Figure 16. ESD response to IEC 61000-4-2 (+8 kV contact discharge)

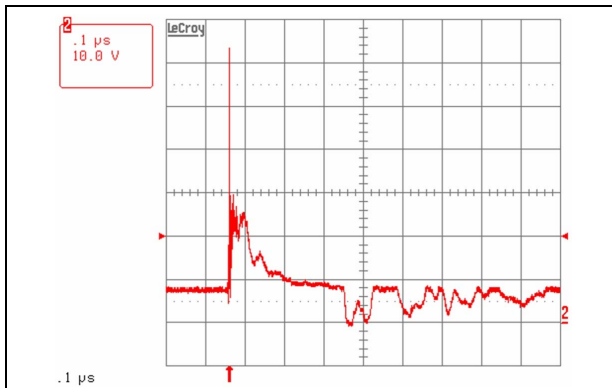

Figure 17. ESD response to IEC 61000-4-2 (-8 kV contact discharge)

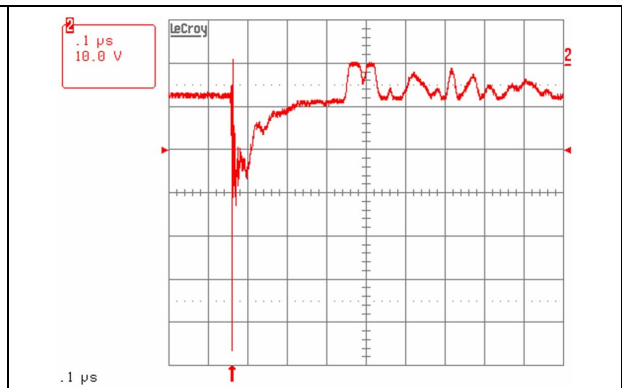

Figure 18. ESD response to IEC 61000-4-2 (+15 kV contact discharge)

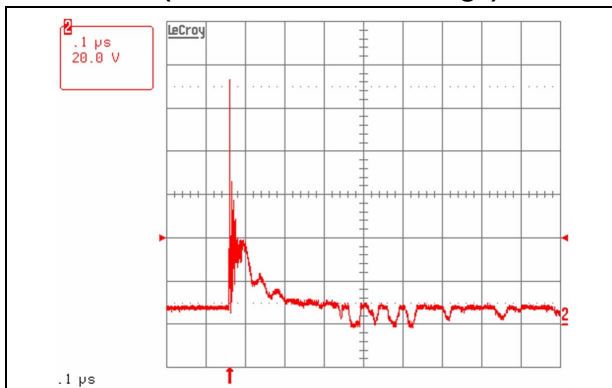
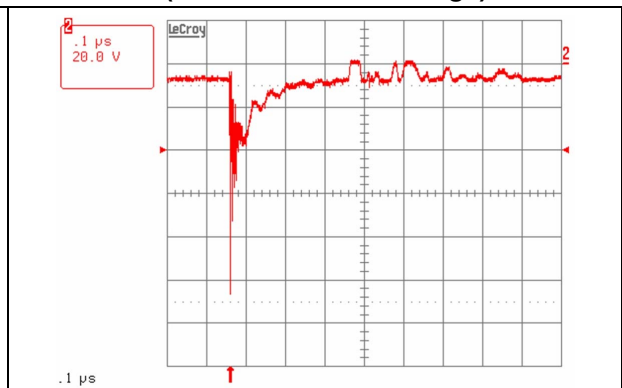
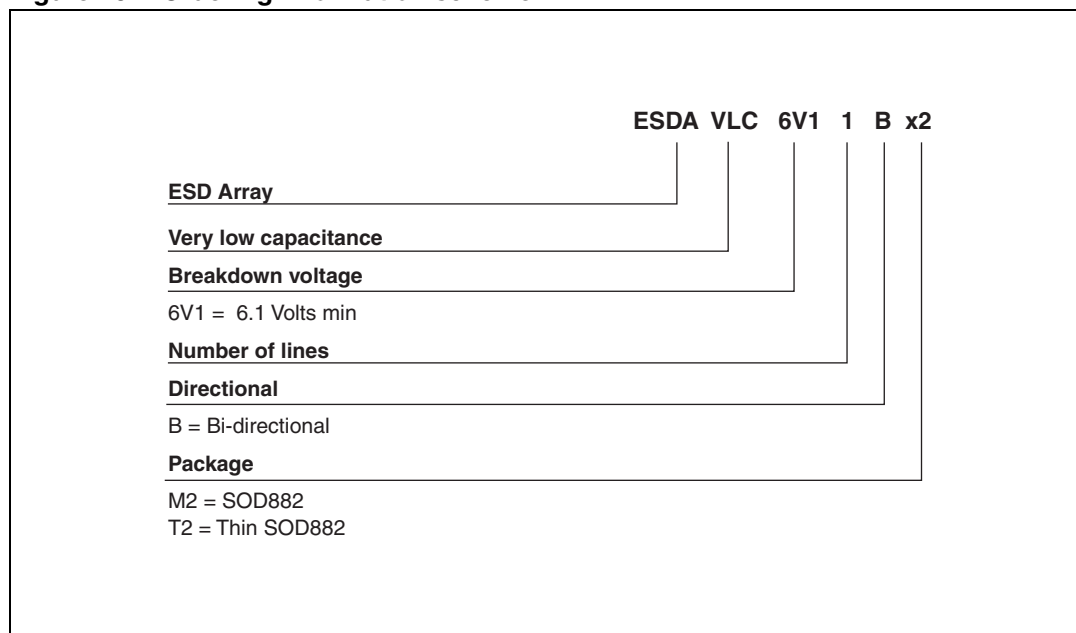

Figure 19. ESD response to IEC 61000-4-2 (-15kV contact discharge)



2 Ordering information scheme

Figure 20. Ordering information scheme



3 Package information

- Epoxy meets UL94, V0

In order to meet environmental requirements, ST offers these devices in ECOPACK® packages. These packages have a lead-free second level interconnect. The category of second level interconnect is marked on the inner box label, in compliance with JEDEC Standard JESD97. The maximum ratings related to soldering conditions are also marked on the inner box label. ECOPACK is an ST trademark. ECOPACK specifications are available at www.st.com.

Table 3. SOD882 dimensions

Ref.	Dimensions					
	Millimeters			Inches		
	Min.	Typ.	Max.	Min.	Typ.	Max.
A	0.40	0.47	0.50	0.016	0.019	0.020
A1	0.00		0.05	0.000		0.002
b1	0.20	0.25	0.30	0.008	0.010	0.012
b2	0.20	0.25	0.30	0.008	0.010	0.012
D		1.00			0.039	
E		0.60			0.024	
e		0.65			0.026	
L1	0.45	0.50	0.55	0.018	0.020	0.022
L2	0.45	0.50	0.55	0.018	0.020	0.022

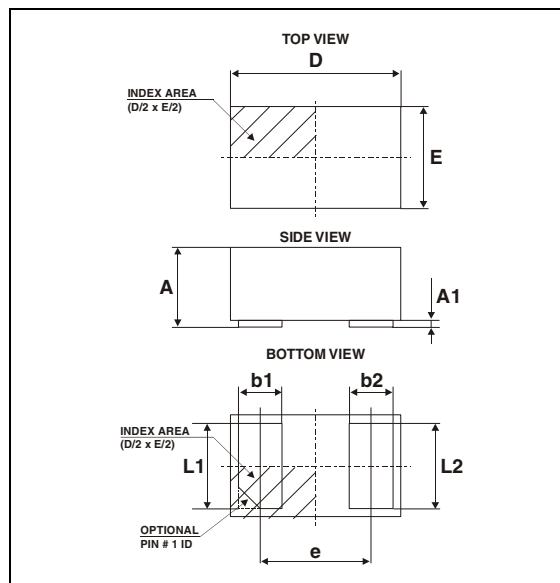
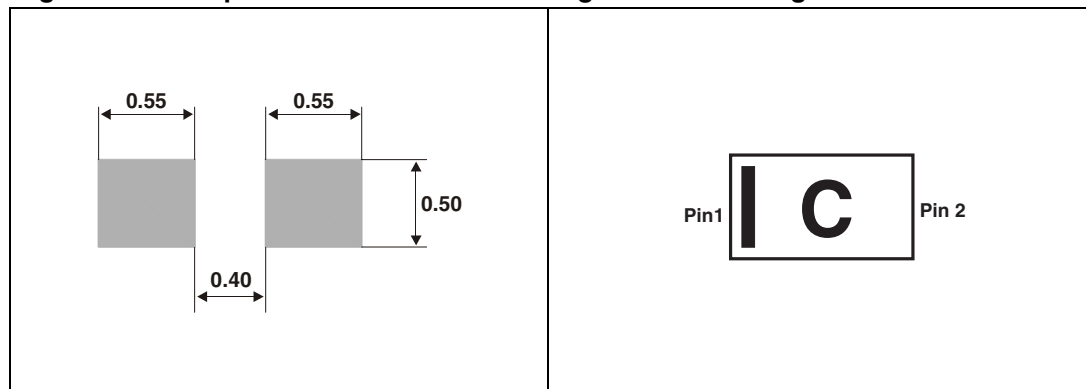

Figure 21. Footprint

Figure 22. Marking



Note: Product marking may be rotated by 90° for assembly plant differentiation. In no case should this product marking be used to orient the component for its placement on a PCB. Only pin 1 mark is to be used for this purpose.

Table 4. Thin SOD882 dimensions

Ref.	Dimensions					
	Millimeters			Inches		
	Min.	Typ.	Max.	Min.	Typ.	Max.
A	0.30		0.40	0.012		0.016
A1	0.00		0.05	0.000		0.002
b1	0.20	0.25	0.30	0.008	0.010	0.012
b2	0.20	0.25	0.30	0.008	0.010	0.012
D		1.00			0.039	
E		0.60			0.024	
e		0.65			0.026	
L1	0.45	0.50	0.55	0.018	0.020	0.022
L2	0.45	0.50	0.55	0.018	0.020	0.022

Figure 23. Footprint

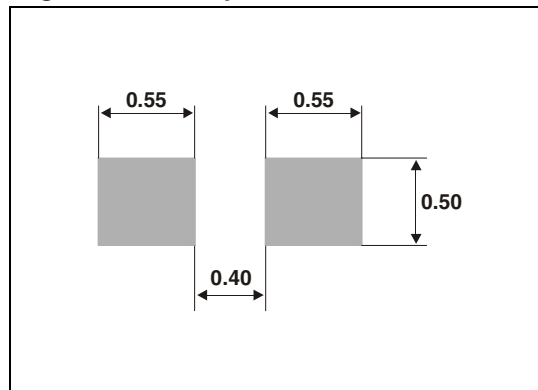
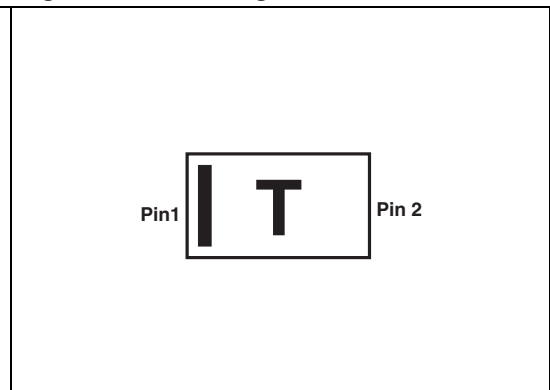
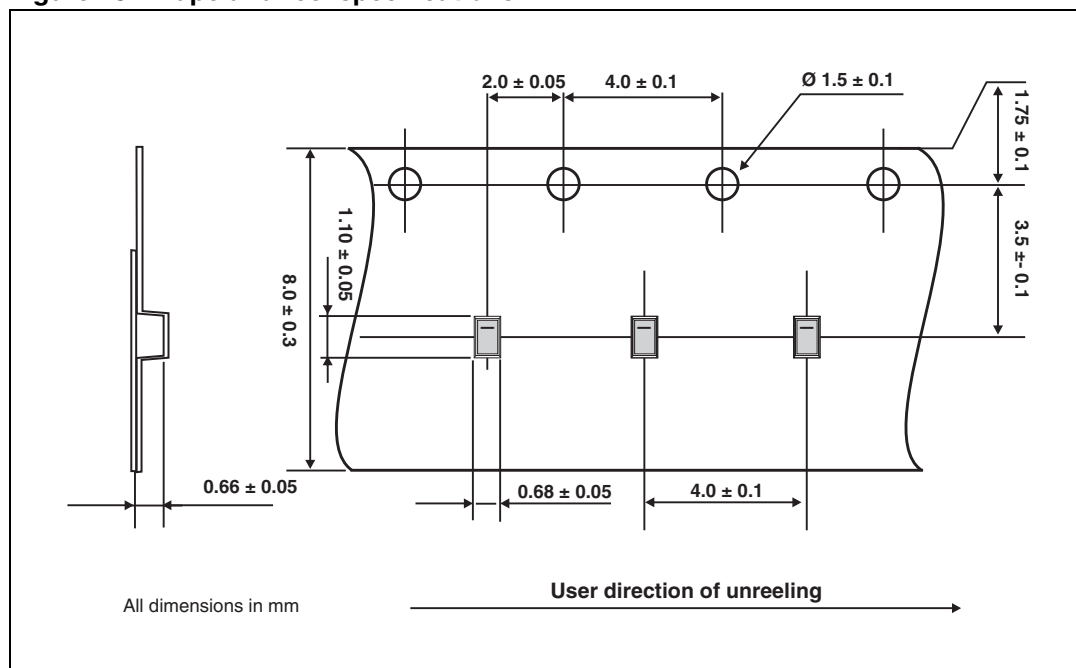

Figure 24. Marking



Note: Product marking may be rotated by 90° for assembly plant differentiation. In no case should this product marking be used to orient the component for its placement on a PCB. Only pin 1 mark is to be used for this purpose.

Figure 25. Tape and reel specifications



4 Recommendation on PCB assembly

4.1 Stencil opening design

1. General recommendation on stencil opening design
 - a) Stencil opening dimensions: L (Length), W (Width), T (Thickness).

Figure 26. Stencil opening dimensions

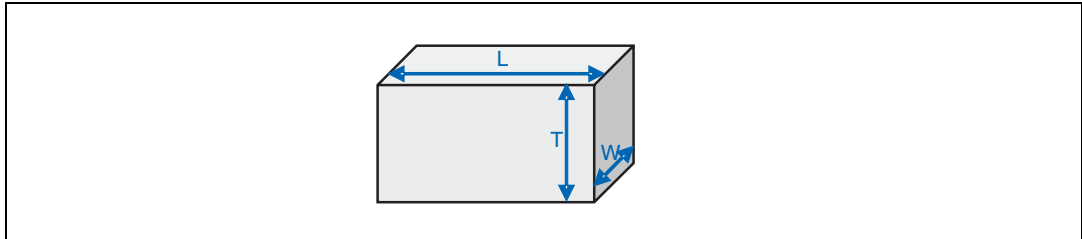

- b) General design rule
 - Stencil thickness (T) = 75 ~ 125 μm
 - Aspect Ratio = $\frac{W}{T} \geq 1.5$
 - Aspect Area = $\frac{L \times W}{2T(L + W)} \geq 0.66$

2. Reference design
 - a) Stencil opening thickness: 100 μm
 - b) Stencil opening for leads: Opening to footprint ratio - between 60% and 65%.

Figure 27. Recommended stencil windows position

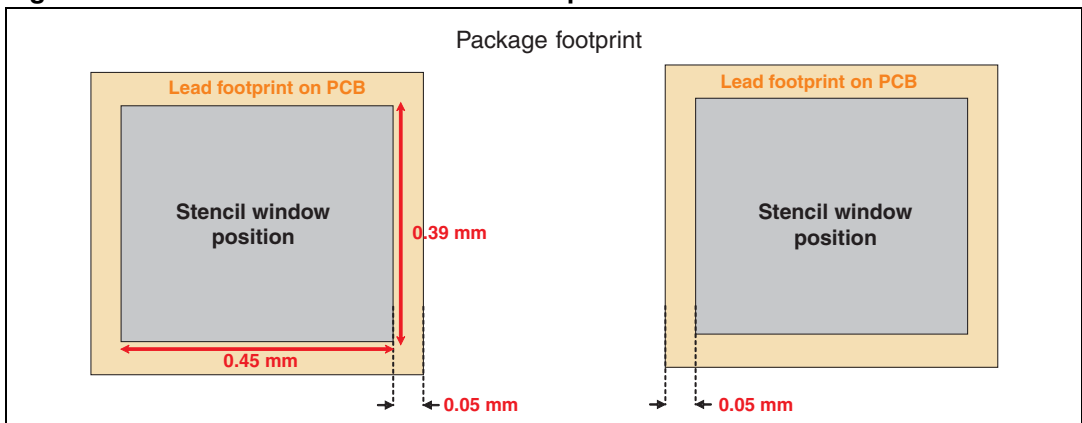

4.2 Solder paste

1. Halide-free flux qualification ROL0 according to ANSI/J-STD-004.
2. “No clean” solder paste is recommended.
3. Offers a high tack force to resist component movement during high speed
4. Solder paste with fine particles: powder particle size is 20-45 μm.

4.3 Placement

1. Manual positioning is not recommended.
2. It is recommended to use the lead recognition capabilities of the placement system, not the outline centering
3. Standard tolerance of ± 0.05 mm is recommended.
4. 3.5 N placement force is recommended. Too much placement force can lead to squeezed out solder paste and cause solder joints to short. Too low placement force can lead to insufficient contact between package and solder paste that could cause open solder joints or badly centered packages.
5. To improve the package placement accuracy, a bottom side optical control should be performed with a high resolution tool.
6. For assembly, a perfect supporting of the PCB (all the more on flexible PCB) is recommended during solder paste printing, pick and place and reflow soldering by using optimized tools.

4.4 PCB design preference

1. To control the solder paste amount, the closed via is recommended instead of open vias.
2. The position of tracks and open vias in the solder area should be well balanced. The symmetrical layout is recommended, in case any tilt phenomena caused by asymmetrical solder paste amount due to the solder flow away.

4.5 Reflow profile

Figure 28. ST ECOPACK® recommended soldering reflow profile for PCB mounting

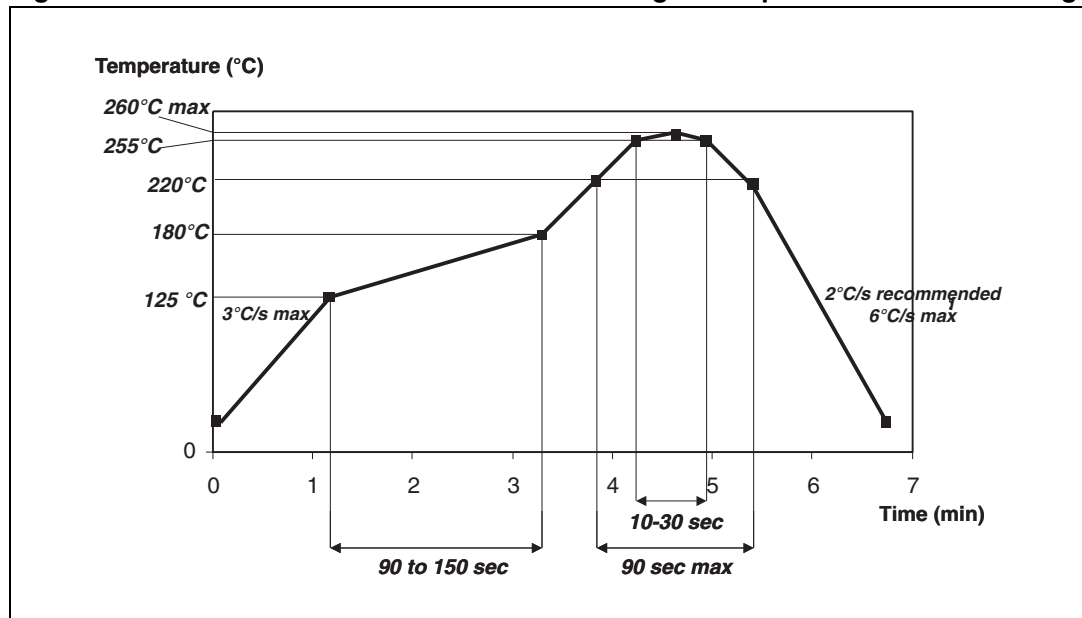

Note: Minimize air convection currents in the reflow oven to avoid component movement.

5 Ordering information

Table 5. Ordering information

Order code	Marking	Package	Weight	Base qty	Delivery mode
ESDAVLC6V1-1BM2	C ⁽¹⁾	SOD882	0.92 mg	3000	Tape and reel
ESDAVLC6V1-1BT2	T ⁽¹⁾	SOD882 Thin	0.76 mg	3000	Tape and reel

1. The marking can be rotated by 90° to differentiate assembly location

6 Revision history

Table 6. Document revision history

Date	Revision	Changes
16-Apr-2008	1	Initial release.

Please Read Carefully:

Information in this document is provided solely in connection with ST products. STMicroelectronics NV and its subsidiaries ("ST") reserve the right to make changes, corrections, modifications or improvements, to this document, and the products and services described herein at any time, without notice.

All ST products are sold pursuant to ST's terms and conditions of sale.

Purchasers are solely responsible for the choice, selection and use of the ST products and services described herein, and ST assumes no liability whatsoever relating to the choice, selection or use of the ST products and services described herein.

No license, express or implied, by estoppel or otherwise, to any intellectual property rights is granted under this document. If any part of this document refers to any third party products or services it shall not be deemed a license grant by ST for the use of such third party products or services, or any intellectual property contained therein or considered as a warranty covering the use in any manner whatsoever of such third party products or services or any intellectual property contained therein.

UNLESS OTHERWISE SET FORTH IN ST'S TERMS AND CONDITIONS OF SALE ST DISCLAIMS ANY EXPRESS OR IMPLIED WARRANTY WITH RESPECT TO THE USE AND/OR SALE OF ST PRODUCTS INCLUDING WITHOUT LIMITATION IMPLIED WARRANTIES OF MERCHANTABILITY, FITNESS FOR A PARTICULAR PURPOSE (AND THEIR EQUIVALENTS UNDER THE LAWS OF ANY JURISDICTION), OR INFRINGEMENT OF ANY PATENT, COPYRIGHT OR OTHER INTELLECTUAL PROPERTY RIGHT.

UNLESS EXPRESSLY APPROVED IN WRITING BY AN AUTHORIZED ST REPRESENTATIVE, ST PRODUCTS ARE NOT RECOMMENDED, AUTHORIZED OR WARRANTED FOR USE IN MILITARY, AIR CRAFT, SPACE, LIFE SAVING, OR LIFE SUSTAINING APPLICATIONS, NOR IN PRODUCTS OR SYSTEMS WHERE FAILURE OR MALFUNCTION MAY RESULT IN PERSONAL INJURY, DEATH, OR SEVERE PROPERTY OR ENVIRONMENTAL DAMAGE. ST PRODUCTS WHICH ARE NOT SPECIFIED AS "AUTOMOTIVE GRADE" MAY ONLY BE USED IN AUTOMOTIVE APPLICATIONS AT USER'S OWN RISK.

Resale of ST products with provisions different from the statements and/or technical features set forth in this document shall immediately void any warranty granted by ST for the ST product or service described herein and shall not create or extend in any manner whatsoever, any liability of ST.

ST and the ST logo are trademarks or registered trademarks of ST in various countries.

Information in this document supersedes and replaces all information previously supplied.

The ST logo is a registered trademark of STMicroelectronics. All other names are the property of their respective owners.

© 2008 STMicroelectronics - All rights reserved

STMicroelectronics group of companies

Australia - Belgium - Brazil - Canada - China - Czech Republic - Finland - France - Germany - Hong Kong - India - Israel - Italy - Japan - Malaysia - Malta - Morocco - Singapore - Spain - Sweden - Switzerland - United Kingdom - United States of America

www.st.com