

Small signal Schottky diodes

Main product characteristics

I_F	350 mA
V_{RRM}	40 V
C (typ)	18 pF
T_j (max)	150° C

Features and benefits

- Low leakage current losses
- Negligible switching losses
- Low forward and reverse recovery times
- Extremely fast switching
- Surface mount device
- Low capacitance diode

Description

The BAT48 series uses 40 V Schottky barrier diodes packaged in SOD-123 or SOD-323. This series is general purpose and features very low turn-on voltage and fast switching

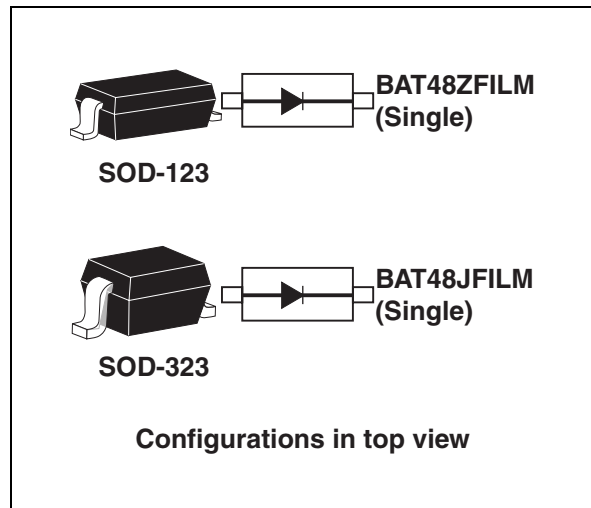

Order codes

Part Number	Marking
BAT48ZFILM	Z48
BAT48JFILM	48

Table 1. Absolute ratings (limiting values at $T_j = 25^\circ\text{C}$, unless otherwise specified)

Symbol	Parameter	Value	Unit
V_{RRM}	Repetitive peak reverse voltage	40	V
I_F	Continuous forward current	350	mA
I_{FSM}	Surge non repetitive forward current	$t_p = 10\text{ ms Sinusoidal}$	A
T_{stg}	Storage temperature range	-65 to +150	°C
T_j	Maximum operating junction temperature	150	°C

1 Characteristics

Table 2. Thermal parameters

Symbol	Parameter		Value	Unit
$R_{th(j-a)}$	Junction to ambient ⁽¹⁾	SOD-123	500	°C/W
		SOD-323	550	

1. Epoxy printed circuit board with recommended pad layout

Table 3. Static electrical characteristics

Symbol	Parameter	Test conditions		Min.	Typ	Max.	Unit
V_{BR}	Breakdown reverse voltage	$T_J = 25^\circ\text{C}$	$I_r = 25\ \mu\text{A}$	40			V
$I_R^{(1)}$	Reverse leakage current	$T_J = 25^\circ\text{C}$	$V_R = 1.5\ \text{V}$			1	μA
			$V_R = 10\ \text{V}$			2	
			$V_R = 20\ \text{V}$			5	
			$V_R = 40\ \text{V}$			25	
		$T_J = 60^\circ\text{C}$	$V_R = 1.5\ \text{V}$			10	
			$V_R = 10\ \text{V}$			15	
			$V_R = 20\ \text{V}$			25	
			$V_R = 40\ \text{V}$			50	
$V_F^{(2)}$	Forward voltage drop	$T_J = 25^\circ\text{C}$	$I_F = 0.1\ \text{mA}$			0.25	V
			$I_F = 1\ \text{mA}$			0.3	
			$I_F = 10\ \text{mA}$			0.4	
			$I_F = 50\ \text{mA}$			0.5	
			$I_F = 200\ \text{mA}$			0.75	
			$I_F = 500\ \text{mA}$			0.9	

1. Pulse test: $t_p = 5\ \text{ms}$, $\delta < 2\%$

2. Pulse test: $t_p = 380\ \mu\text{s}$, $\delta < 2\%$

Table 4. Dynamic characteristics

Symbol	Parameter	Test conditions	Min.	Typ	Max.	Unit
C	Diode capacitance	$V_R = 0\ \text{V}$, $F = 1\ \text{MHz}$		30		pF
		$V_R = 1\ \text{V}$, $F = 1\ \text{MHz}$		18		

Figure 1. Average forward power dissipation versus average forward current

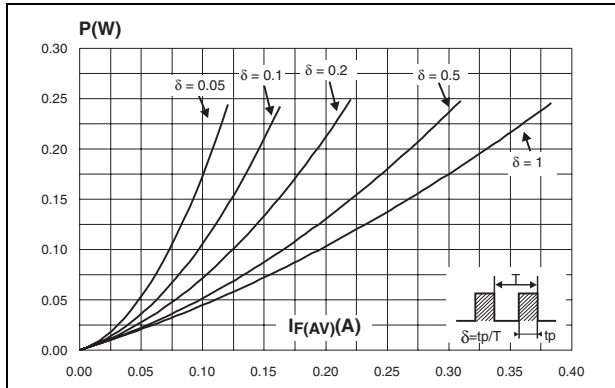

Figure 2. Average forward current versus ambient temperature (delta = 1)

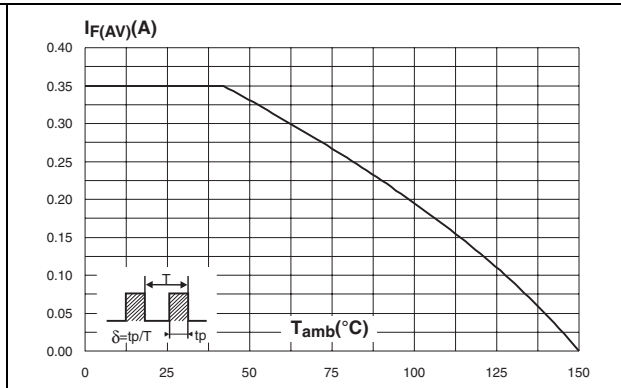

Figure 3. Reverse leakage current versus reverse applied voltage (typical values)

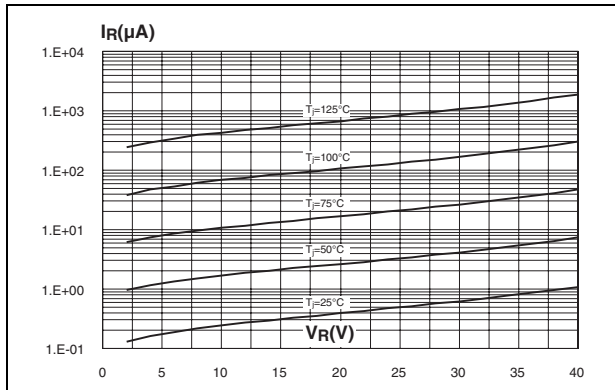

Figure 4. Reverse leakage current versus junction temperature (typical values)

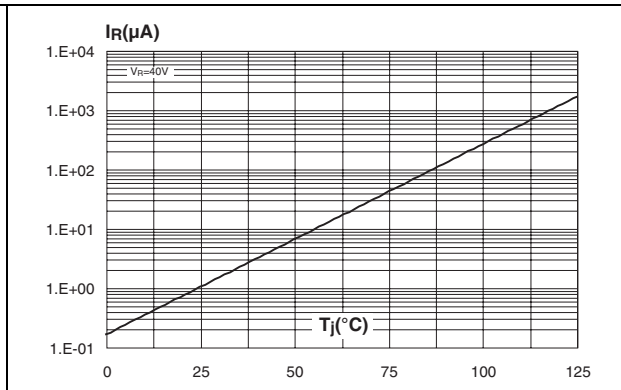

Figure 5. Junction capacitance versus reverse applied voltage (typical values)

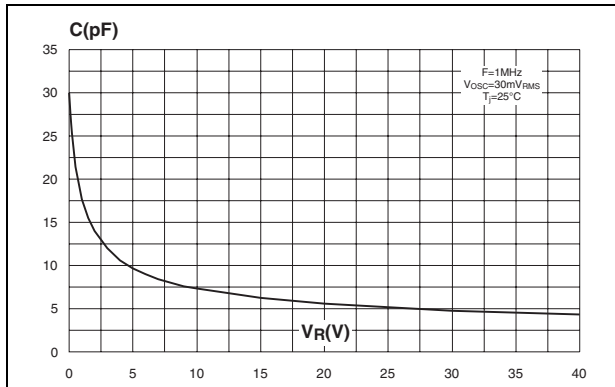

Figure 6. Forward voltage drop versus forward current (typical values)

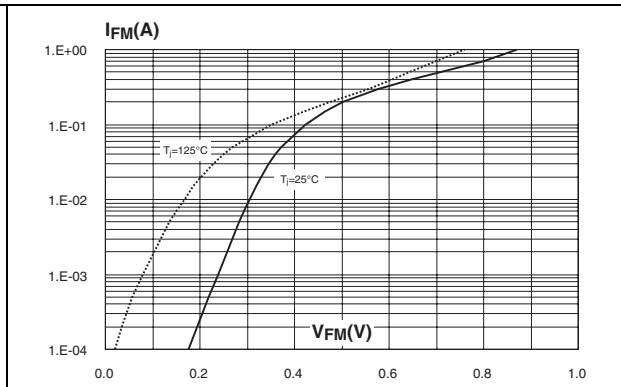

Figure 7. Relative variation of thermal impedance junction to ambient versus pulse duration (epoxy FR4 with recommended pad layout, $e_{CU} = 35 \mu m$) (SOD-323)

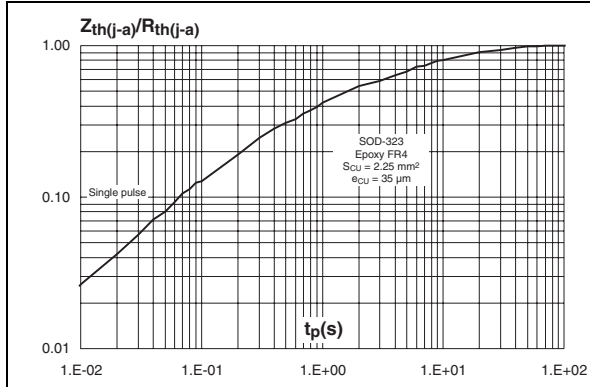
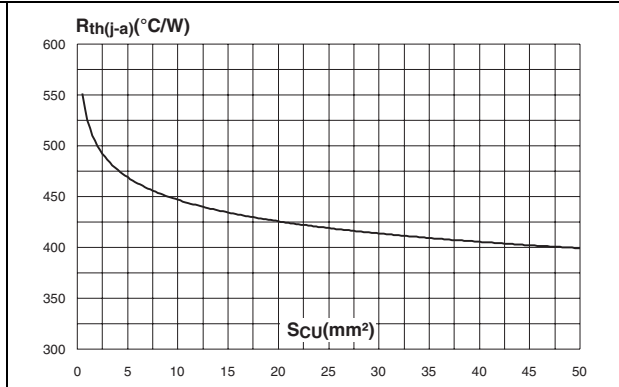
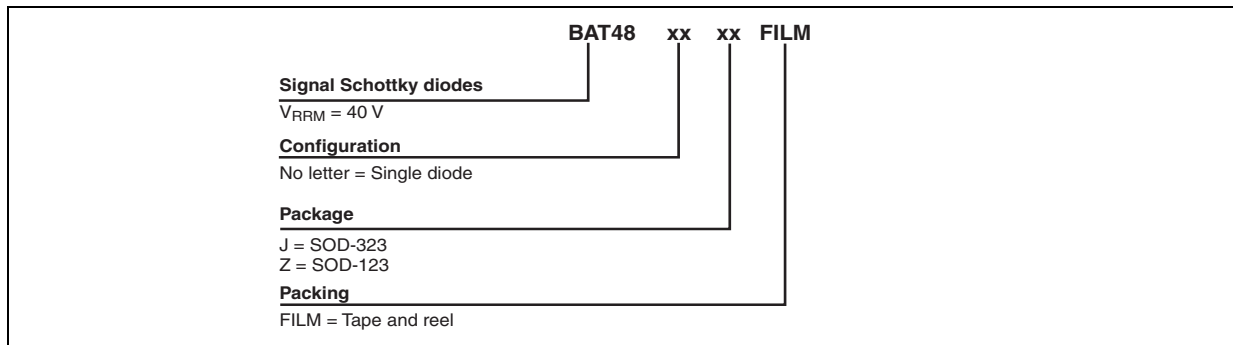

Figure 8. Thermal resistance junction to ambient versus copper surface under each lead (printed circuit board, epoxy FR4, $e_{CU}=35 \mu m$, SOD-323)



2 Ordering information scheme



3 Package information

Epoxy meets UL94, V0

Table 5. SOD-123 dimensions

Ref.	Dimensions			
	Millimeters		Inches	
	Min.	Max.	Min.	Max.
A		1.45		0.057
A1	0	0.1	0	0.004
A2	0.85	1.35	0.033	0.053
b	0.55 Typ.		0.022 Typ.	
c	0.15 Typ.		0.039 Typ.	
D	2.55	2.85	0.1	0.112
E	1.4	1.7	0.055	0.067
G	0.25		0.01	
H	3.55	3.95	0.14	0.156

Figure 9. SOD-123 footprint (dimensions in mm)

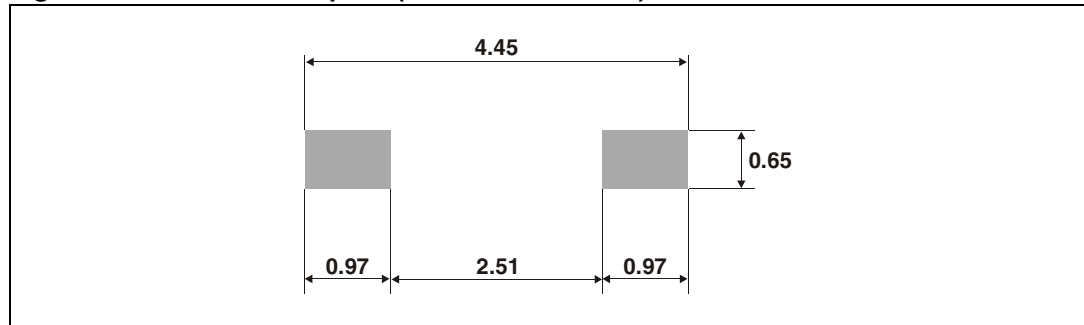
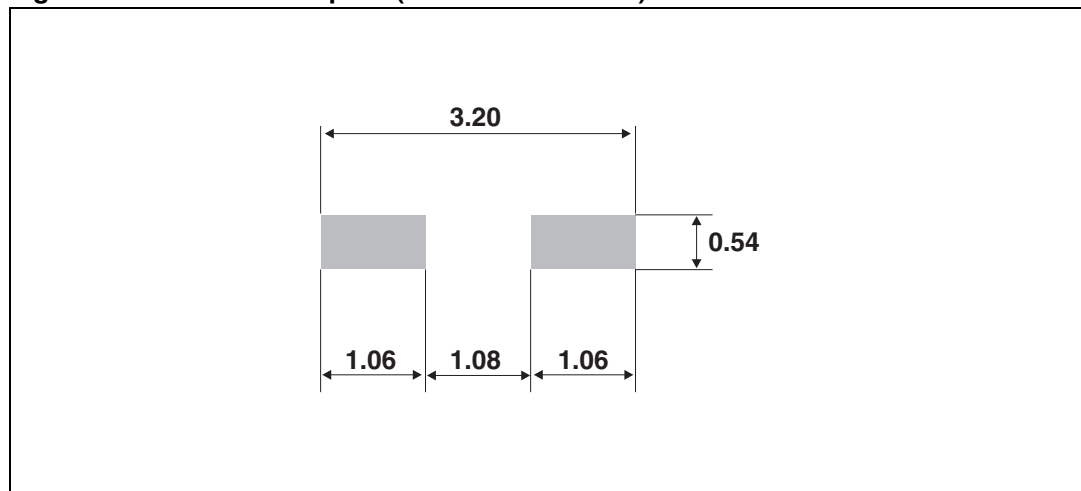

Table 6. SOD-323 dimensions

Ref.	Dimensions			
	Millimeters		Inches	
	Min.	Max.	Min.	Max.
A		1.17		0.046
A1	0	0.1	0	0.004
b	0.25	0.44	0.01	0.017
c	0.1	0.25	0.004	0.01
D	1.52	1.8	0.06	0.071
E	1.11	1.45	0.044	0.057
H	2.3	2.7	0.09	0.106
L	0.1	0.46	0.004	0.02
Q1	0.1	0.41	0.004	0.016

Figure 10. SOD-323 footprint (dimensions in mm)



In order to meet environmental requirements, ST offers these devices in ECOPACK® packages. These packages have a lead-free second level interconnect. The category of second level interconnect is marked on the package and on the inner box label, in compliance with JEDEC Standard JESD97. The maximum ratings related to soldering conditions are also marked on the inner box label. ECOPACK is an ST trademark. ECOPACK specifications are available at: www.st.com.

4 Ordering information

Part Number	Marking	Package	Weight	Base qty	Delivery mode
BAT48ZFILM	Z48	SOD-123 Single	10 mg	3000	Tape and reel
BAT48JFILM	48	SOD-323 Single	5 mg	3000	Tape and reel

5 Revision history

Date	Revision	Description of Changes
08-Aug-2006	1	Initial release.

Please Read Carefully:

Information in this document is provided solely in connection with ST products. STMicroelectronics NV and its subsidiaries ("ST") reserve the right to make changes, corrections, modifications or improvements, to this document, and the products and services described herein at any time, without notice.

All ST products are sold pursuant to ST's terms and conditions of sale.

Purchasers are solely responsible for the choice, selection and use of the ST products and services described herein, and ST assumes no liability whatsoever relating to the choice, selection or use of the ST products and services described herein.

No license, express or implied, by estoppel or otherwise, to any intellectual property rights is granted under this document. If any part of this document refers to any third party products or services it shall not be deemed a license grant by ST for the use of such third party products or services, or any intellectual property contained therein or considered as a warranty covering the use in any manner whatsoever of such third party products or services or any intellectual property contained therein.

UNLESS OTHERWISE SET FORTH IN ST'S TERMS AND CONDITIONS OF SALE ST DISCLAIMS ANY EXPRESS OR IMPLIED WARRANTY WITH RESPECT TO THE USE AND/OR SALE OF ST PRODUCTS INCLUDING WITHOUT LIMITATION IMPLIED WARRANTIES OF MERCHANTABILITY, FITNESS FOR A PARTICULAR PURPOSE (AND THEIR EQUIVALENTS UNDER THE LAWS OF ANY JURISDICTION), OR INFRINGEMENT OF ANY PATENT, COPYRIGHT OR OTHER INTELLECTUAL PROPERTY RIGHT.

UNLESS EXPRESSLY APPROVED IN WRITING BY AN AUTHORIZED ST REPRESENTATIVE, ST PRODUCTS ARE NOT RECOMMENDED, AUTHORIZED OR WARRANTED FOR USE IN MILITARY, AIR CRAFT, SPACE, LIFE SAVING, OR LIFE SUSTAINING APPLICATIONS, NOR IN PRODUCTS OR SYSTEMS WHERE FAILURE OR MALFUNCTION MAY RESULT IN PERSONAL INJURY, DEATH, OR SEVERE PROPERTY OR ENVIRONMENTAL DAMAGE. ST PRODUCTS WHICH ARE NOT SPECIFIED AS "AUTOMOTIVE GRADE" MAY ONLY BE USED IN AUTOMOTIVE APPLICATIONS AT USER'S OWN RISK.

Resale of ST products with provisions different from the statements and/or technical features set forth in this document shall immediately void any warranty granted by ST for the ST product or service described herein and shall not create or extend in any manner whatsoever, any liability of ST.

ST and the ST logo are trademarks or registered trademarks of ST in various countries.

Information in this document supersedes and replaces all information previously supplied.

The ST logo is a registered trademark of STMicroelectronics. All other names are the property of their respective owners.

© 2006 STMicroelectronics - All rights reserved

STMicroelectronics group of companies

Australia - Belgium - Brazil - Canada - China - Czech Republic - Finland - France - Germany - Hong Kong - India - Israel - Italy - Japan - Malaysia - Malta - Morocco - Singapore - Spain - Sweden - Switzerland - United Kingdom - United States of America

www.st.com