

PRELIMINARY SPEC

Features

- SUBMINIATURE PACKAGE.
- WIDE VIEWING ANGLE.
- Z-BEND LEAD.
- LONG LIFE-SOLID STATE RELIABILITY.
- LOW PACKAGE PROFILE.
- PACKAGE : 1000PCS / REEL.
- MOISTURE SENSITIVITY LEVEL : LEVEL 3.
- RoHS COMPLIANT.



Notes:

1. All dimensions are in millimeters (inches).
2. Tolerance is $\pm 0.25(0.01)$ " unless otherwise noted.
- 3.Specifications are subject to change without notice.

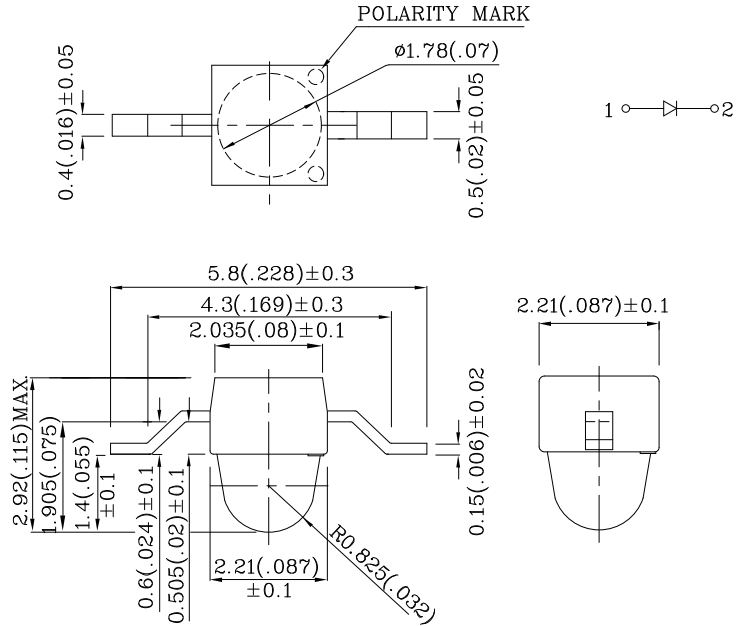

Absolute Maximum Ratings (TA=25°C)		MDK (InGaAlP)	Unit
Reverse Voltage	V _R	5	V
Forward Current	I _F	30	mA
Forward Current (Peak) 1/10 Duty Cycle 0.1ms Pulse Width	i _{FS}	185	mA
Power Dissipation	P _T	75	mW
Operating Temperature	T _A	-40 ~ +85	°C
Storage Temperature	T _{stg}	-40 ~ +85	

Operating Characteristics (TA=25°C)		MDK (InGaAlP)	Unit
Forward Voltage (Typ.) (I _F =20mA)	V _F	1.95	V
Forward Voltage (Max.) (I _F =20mA)	V _F	2.5	V
Reverse Current (Max.) (V _R =5V)	I _R	10	uA
Wavelength of Peak Emission (Typ.) (I _F =20mA)	λ P	650	nm
Wavelength of Dominant Emission (Typ.) (I _F =20mA)	λ D	635	nm
Spectral Line Full Width At Half-Maximum (Typ.) (I _F =20mA)	Δλ	28	nm
Capacitance (Typ.) (V _F =0V, f=1MHz)	C	35	pF

Part Number	Emitting Color	Emitting Material	Lens-color	Luminous Intensity (I _F =20mA) med		Wavelength nm λ P	Viewing Angle 2 θ 1/2
				min.	typ.		
ZMDK64W-9	Red	InGaAlP	Water Clear	480	1395	650	20°

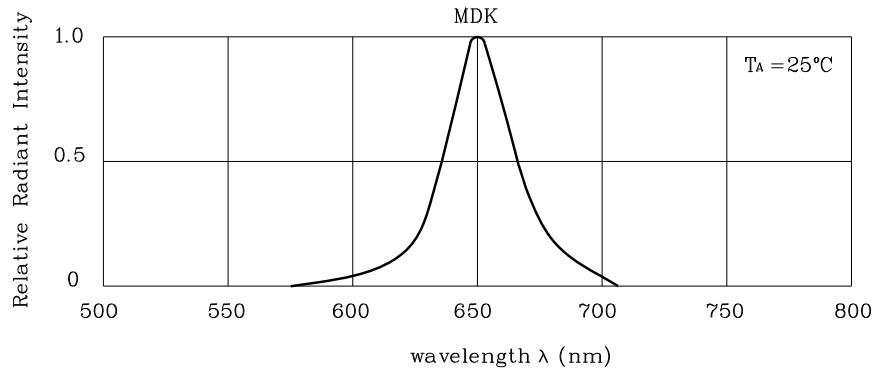

RELATIVE INTENSITY Vs. WAVELENGTH

❖ MDK

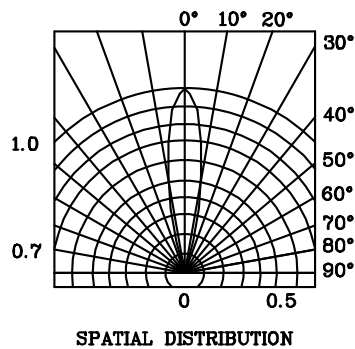
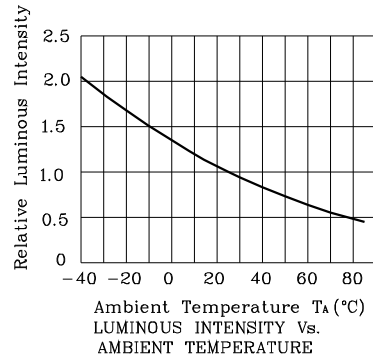
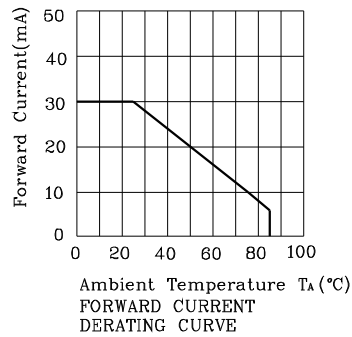
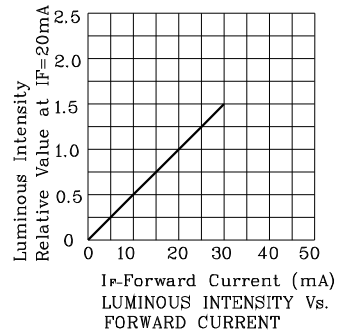
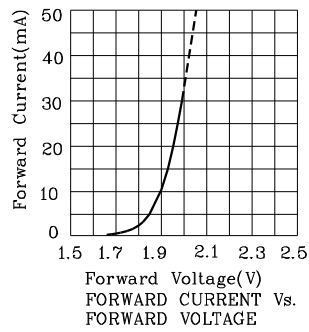

Reflow Soldering Profile For Lead-free SMT Process.

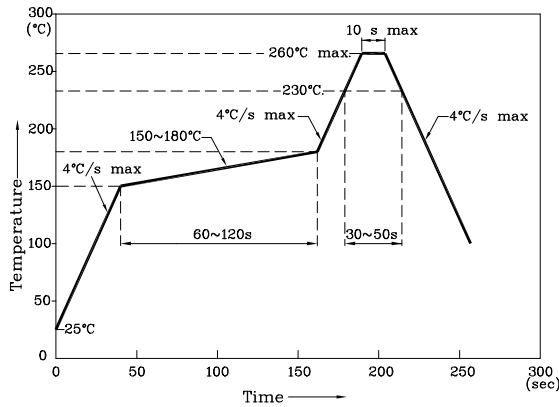

NOTES:

1. Maximum soldering temperature should not exceed 260°C.
2. Recommended reflow temperature: 145°C-260°C.
3. Do not put stress to the epoxy resin during high temperatures conditions.

❖ Recommended Soldering Pattern
(Units : mm; Tolerance:± 0.1)

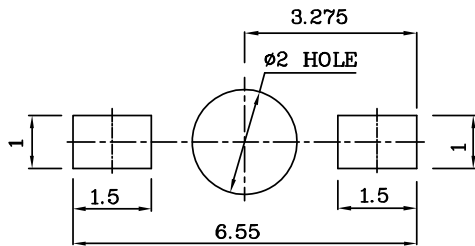

❖ The device has a single mounting surface. The device must be mounted according to the specifications.

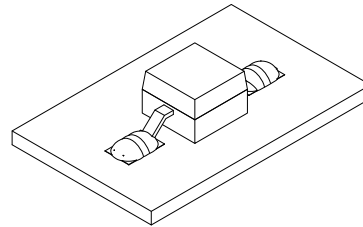

❖ Tape Specification (Units : mm)

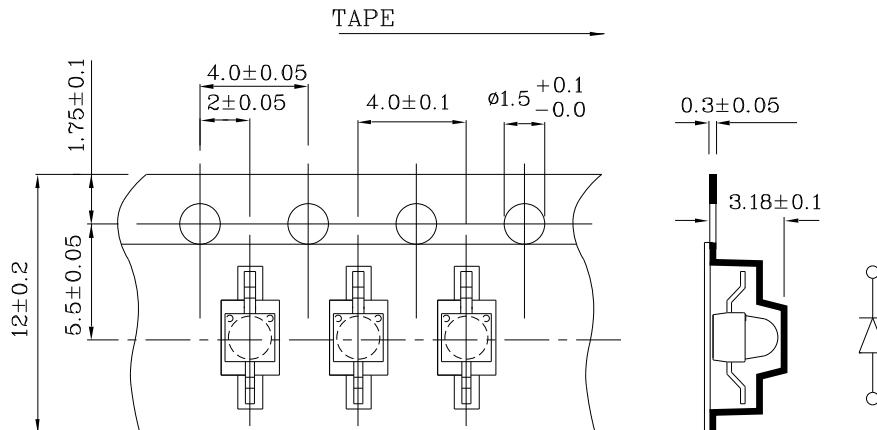

Remarks:

If special sorting is required (e.g. binning based on forward voltage, Luminous intensity / luminous flux, or wavelength), the typical accuracy of the sorting process is as follows:

1. Wavelength: +/-1nm
2. Luminous intensity / luminous flux: +/-15%
3. Forward Voltage: +/-0.1V

Note: Accuracy may depend on the sorting parameters.

PACKING & LABEL SPECIFICATIONS

ZMDK64W-9

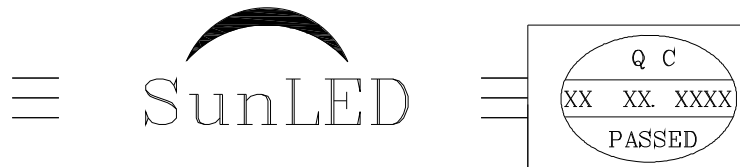
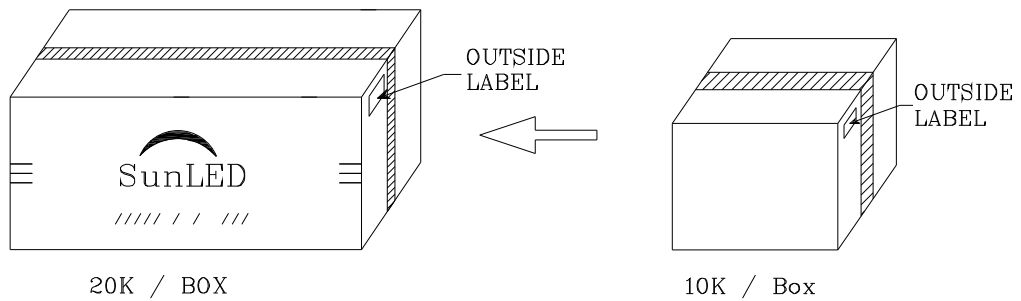
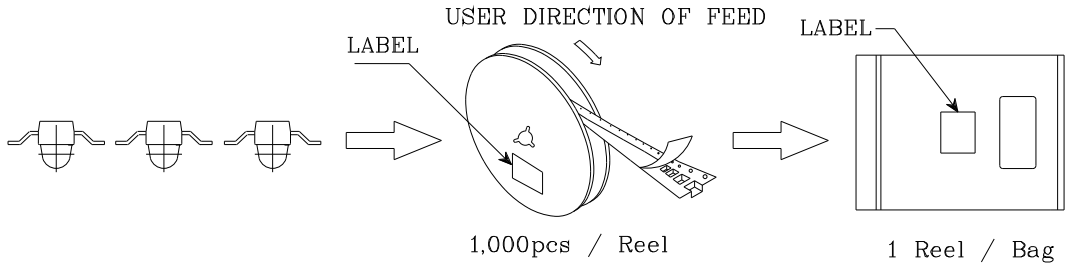

P/NO : Zxx64x-9	
QTY : 1,000 pcs	CODE: XXX
S/N : XX	
LOT NO:	
 XXXXXXXXXXXXXXXXXXXXX	
RoHS Compliant	