

**2200 – 2500MHz VCO**

**FEATURES**

- Industry Standard 12.7x12.7mm SMT Footprint
- +5Vdc Supply Voltage
- -40°C to +85°C Temp. Range
- Low Phase Noise
- Tape & Reel Packaging
- Fully compliant to RoHS Directive 2002/95/EC

**DESCRIPTION**

The CTS VCO3069 is a high performance SMT VCO. Its low phase noise makes it the ideal choice for any wireless telecommunications system.

- See [WWW.CTSCORP.COM](http://WWW.CTSCORP.COM) for product patent status.

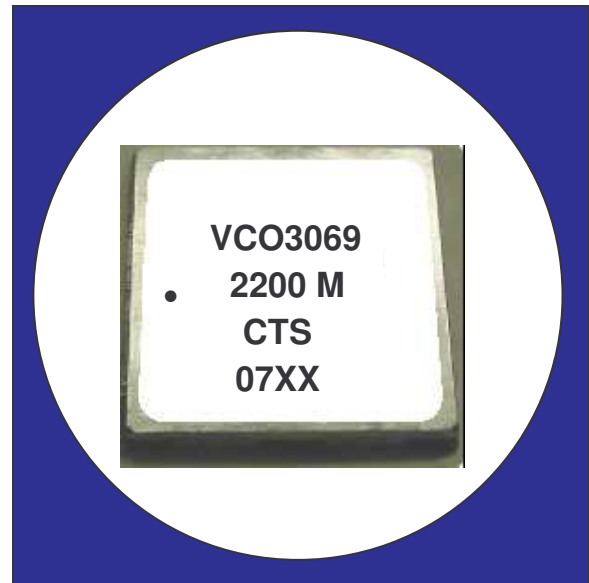

**ELECTRICAL SPECIFICATIONS**

Parameter	Conditions & Remarks	Min	Typical	Max	Unit
Operating Frequency	F <sub>OUT</sub>	2200	-	2500	MHz
Supply Voltage	V <sub>CC</sub>	4.75	5	5.25	Vdc
Supply Current	I <sub>CC</sub>	-	12	18	mA
Operating Temperature Range	T <sub>OP</sub>	-40	-	+85	°C
Storage Temperature Range	T <sub>STG</sub>	-40	-	+125	°C
Tuning Voltage Range	V <sub>T</sub>	1	-	10	Vdc
Tuning Sensitivity	@ V <sub>t</sub> = 5.5V	-	50	-	MHz/V
Power Output	50 Ohms	0	3	6	dBm
Pushing	(5.0V +/- .25V)	-3	-	3	MHz/V
Pulling	(12db return loss)	-3	-	3	MHz
Harmonics		-	-	-15	dBc
Spurious response		-	-	-75	dBc
Output Impedance		-	50	-	Ohms
Phase Noise	1kHz	-	-74	-70	dBc/Hz
	10kHz	-	-95	-92	dBc/Hz
	100KHz	-	-116	-112	dBc/Hz
	1MHz	-	-134	-132	dBc/Hz

**MECHANICAL SPECIFICATIONS:**

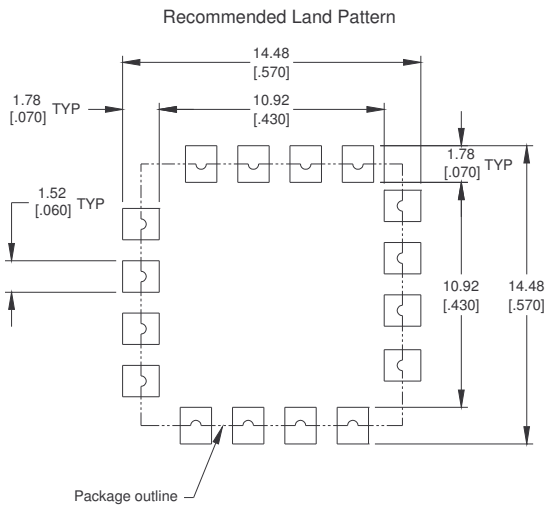
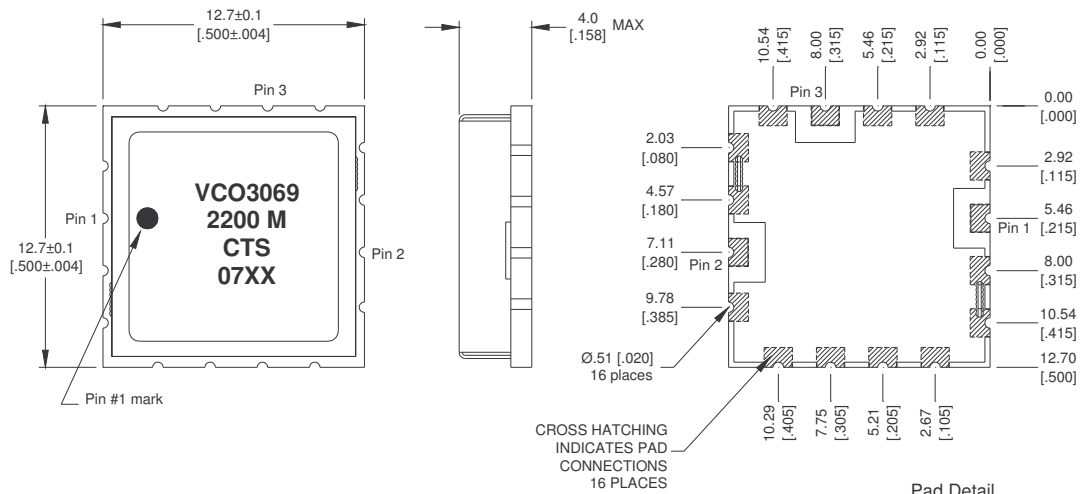

Function table

Pin	Function
1	Vt
2	RF Output
3	Vcc
4-16	GND

Note: The Lid/Sheild is grounded.

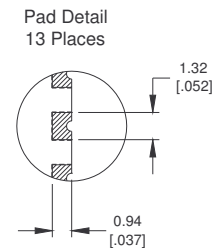
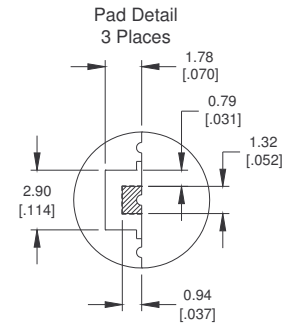
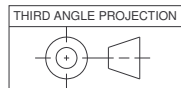

All dimensions are in MM [Inches].  
 All dimensions are nominal unless otherwise specified.  
 Lead Termination Finish: Gold Flash, <10 micro inch, over Ni plated Cu.

**Tape & Reel Information:**

Tape width 24 mm, pitch 16 mm, as per EIA 481-2, 1000 units max per 330 mm reel.

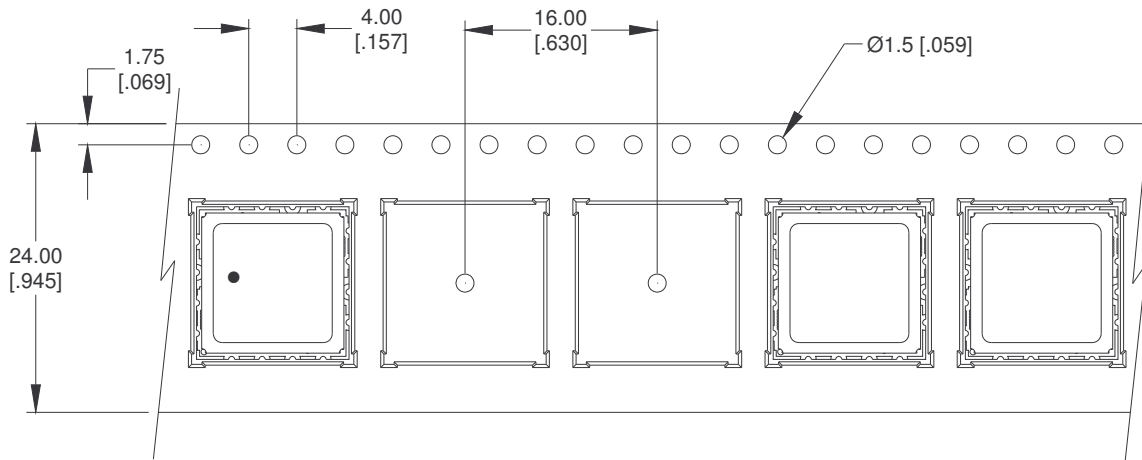

All dimensions are in MM [INCHES].

All dimensions are Nominal

**STANDARD ENVIRONMENTAL LIMITS:**

This product is capable of operating within the following environmental conditions:

**Operating Temperature:** -40 to +85 °C.

**Storage Temperature:** -40 to +125°C.

**Humidity:** 85% Relative humidity max @ 50°C.

**Solder Reflow Conditions:** Device is capable of withstanding reflow of 260 degrees C for 10 seconds maximum.

**Atmospheric Pressure:** 730 to 780 mm Hg.

**Moisture Sensitivity:** MSL 1

**RoHS:** This device is fully compliant to RoHS Directive 2002/95/EC