



TSM2301

-20V P-Channel Enhancement Mode MOSFET

SOT-23



Pin assignment:

1. Gate
2. Source
3. Drain

$V_{DS} = -20V$

$R_{DS(on)}, V_{GS} @ -4.5V, I_{DS} @ -2.8A = 130m\Omega$

$R_{DS(on)}, V_{GS} @ -2.5V, I_{DS} @ -2.0A = 190m\Omega$

Features

- ◇ Advanced trench process technology
- ◇ High density cell design for ultra low on-resistance
- ◇ Excellent thermal and electrical capabilities
- ◇ Compact and low profile SOT-23 package

Block Diagram

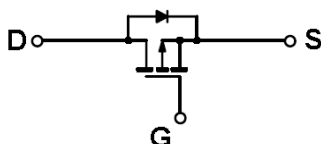

Ordering Information

| Part No. | Packing | Package |
|-----------|-------------|---------|
| TSM2301CX | Tape & Reel | SOT-23 |

Absolute Maximum Rating (Ta = 25 °C unless otherwise noted)

| Parameter | Symbol | Limit | Unit |
|--|----------------|--------------|------|
| Drain-Source Voltage | V_{DS} | -20V | V |
| Gate-Source Voltage | V_{GS} | ±8 | V |
| Continuous Drain Current | I_D | -2.3 | A |
| Pulsed Drain Current | I_{DM} | -10 | A |
| Maximum Power Dissipation | P_D | Ta = 25 °C | 1.25 |
| | | Ta = 75 °C | 0.8 |
| Operating Junction Temperature | T_J | +150 | °C |
| Operating Junction and Storage Temperature Range | T_J, T_{STG} | - 55 to +150 | °C |

Thermal Performance

| Parameter | Symbol | Limit | Unit |
|--|-----------------|-------|------|
| Lead Temperature (1/8" from case) | T_L | 5 | S |
| Junction to Ambient Thermal Resistance (PCB mounted) | $R_{\theta ja}$ | 100 | °C/W |

Note: Surface mounted on FR4 board t<=5sec.

| Electrical Characteristics | | | | | | |
|------------------------------------|---|---------------------|-------|------|------|------|
| Ta = 25 °C, unless otherwise noted | | | | | | |
| Parameter | Conditions | Symbol | Min | Typ | Max | Unit |
| Static | | | | | | |
| Drain-Source Breakdown Voltage | V _{GS} = 0V, I _D = - 250uA | BV _{DSS} | -20 | -- | -- | V |
| Drain-Source On-State Resistance | V _{GS} = -4.5V, I _D = -2.8A | R _{DS(ON)} | -- | 95 | 130 | mΩ |
| Drain-Source On-State Resistance | V _{GS} = -2.5V, I _D = -2.0A | R _{DS(ON)} | -- | 122 | 190 | |
| Gate Threshold Voltage | V _{DS} = V _{GS} , I _D = - 250uA | V _{GS(TH)} | -0.45 | -- | -- | V |
| Zero Gate Voltage Drain Current | V _{DS} = -16V, V _{GS} = 0V | I _{DSS} | -- | -- | -1.0 | uA |
| Gate Body Leakage | V _{GS} = ±8V, V _{DS} = 0V | I _{GSS} | -- | -- | ±100 | nA |
| On-State Drain Current | V _{DS} ≥ -10V, V _{GS} = -5V | I _{D(ON)} | -6 | -- | -- | A |
| Forward Transconductance | V _{DS} = - 5V, I _D = - 4A | g _{fs} | -- | 6.5 | -- | S |
| Dynamic | | | | | | |
| Total Gate Charge | V _{DS} = -6V, I _D = -2.8A, V _{GS} = -4.5V | Q _g | -- | 5.4 | 10 | nC |
| Gate-Source Charge | | Q _{gs} | -- | 0.8 | -- | |
| Gate-Drain Charge | | Q _{gd} | -- | 1.1 | -- | |
| Turn-On Delay Time | V _{DD} = -6V, R _L = 6Ω, I _D = -1A, V _{GEN} = -4.5V, R _G = 6Ω | t _{d(on)} | -- | 5 | 25 | nS |
| Turn-On Rise Time | | t _r | -- | 19 | 60 | |
| Turn-Off Delay Time | | t _{d(off)} | -- | 95 | 110 | |
| Turn-Off Fall Time | | t _f | -- | 65 | 80 | |
| Input Capacitance | V _{DS} = -6V, V _{GS} = 0V, f = 1.0MHz | C _{iss} | -- | 447 | -- | pF |
| Output Capacitance | | C _{oss} | -- | 127 | -- | |
| Reverse Transfer Capacitance | | C _{rss} | -- | 80 | -- | |
| Source-Drain Diode | | | | | | |
| Max. Diode Forward Current | | I _S | -- | -- | -2.4 | A |
| Diode Forward Voltage | I _S = - 1.6A, V _{GS} = 0V | V _{SD} | -- | -0.8 | -1.2 | V |

Note : pulse test: pulse width ≤300uS, duty cycle ≤2%

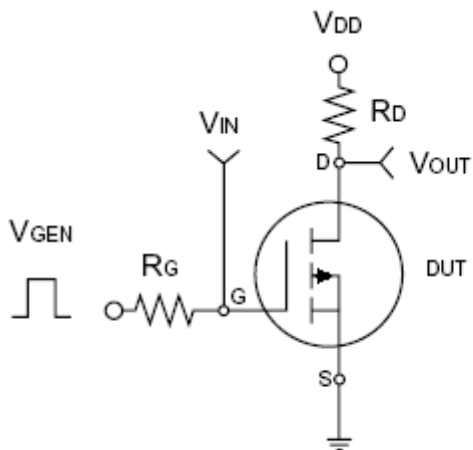

Switching Test Circuit

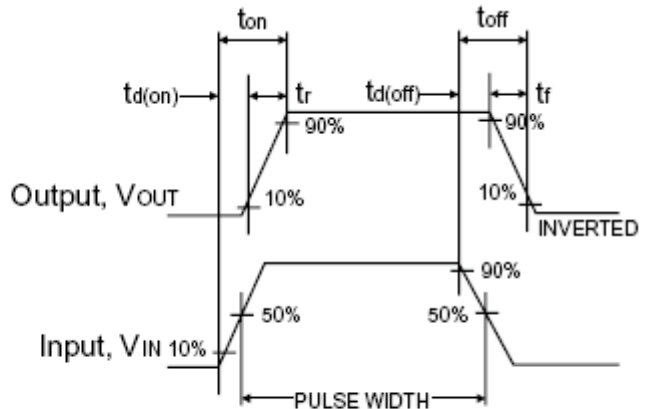

Switchin Waveforms



Typical Characteristics Curve ($T_a = 25^\circ\text{C}$ unless otherwise noted)

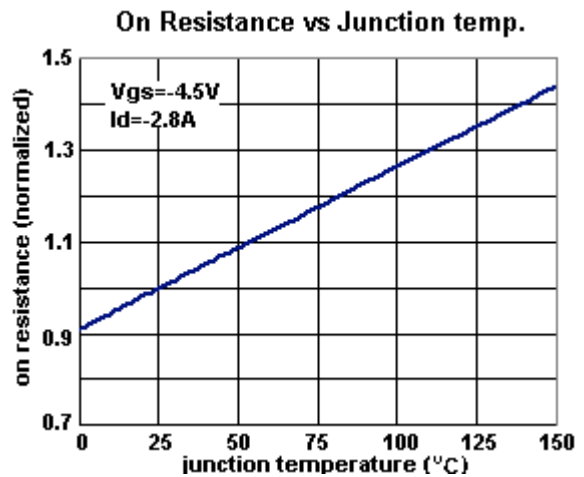
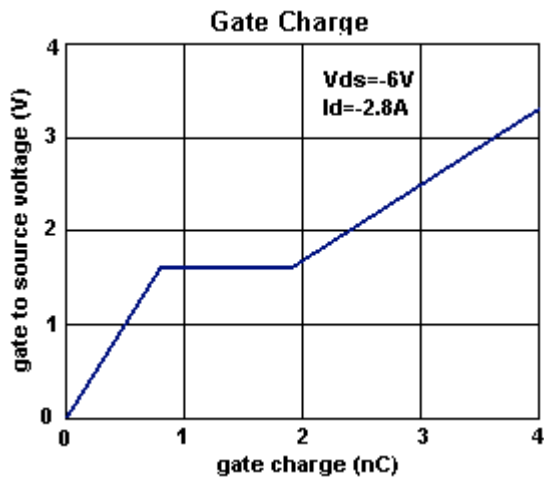
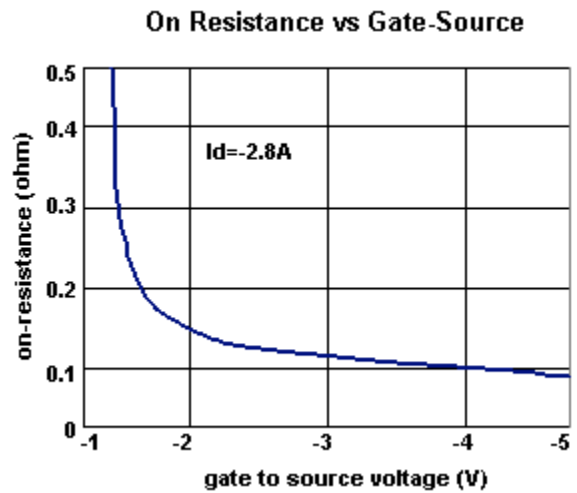
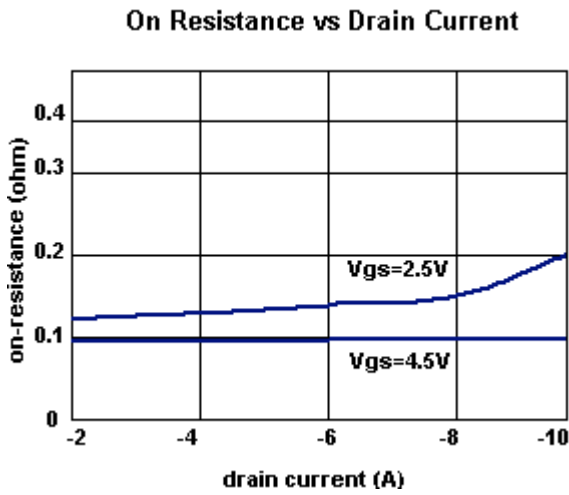
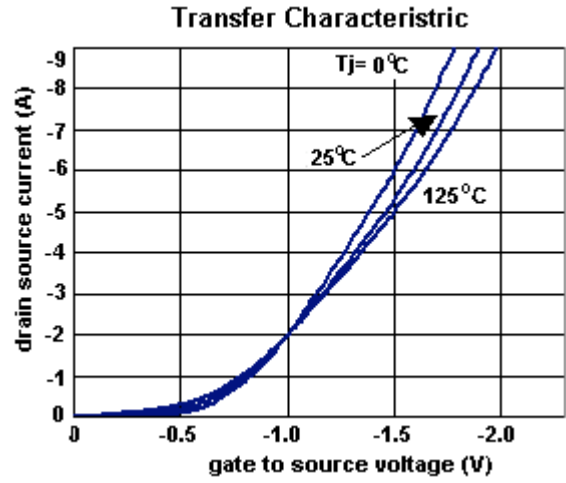
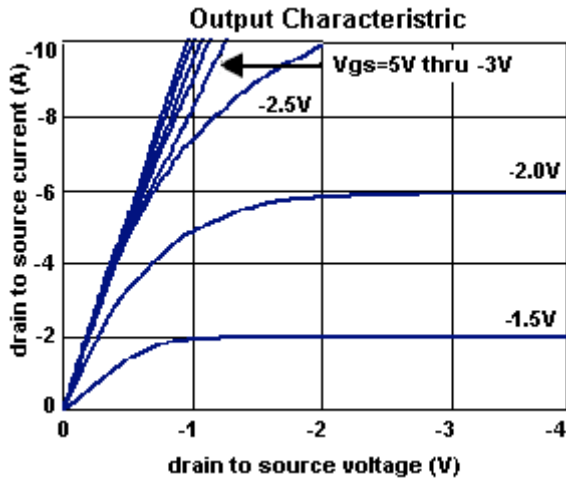



Typical Characteristics Curve (Ta = 25 °C unless otherwise noted)

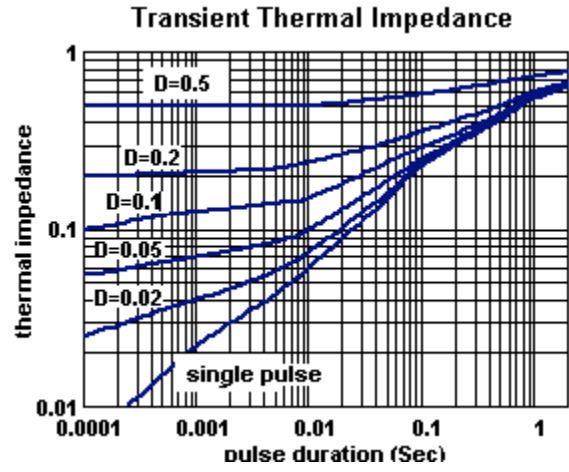
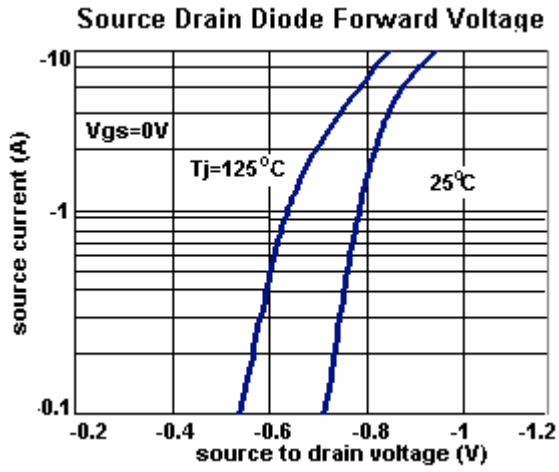

Marking Indication

P/N: TSM2301CX
Package: SOT-23

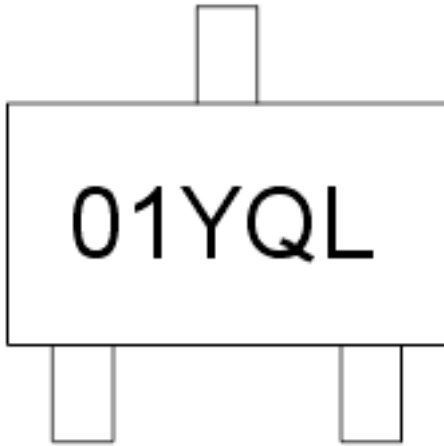

- * 01 = Product code for TSM2301
- * YQL = Date Code
 - Y = Year Code
 - Q = Quarter Code (Q1=A, Q2=B, Q3=C, Q4=D)
 - L = Lot Number

SOT-23 Mechanical Drawing

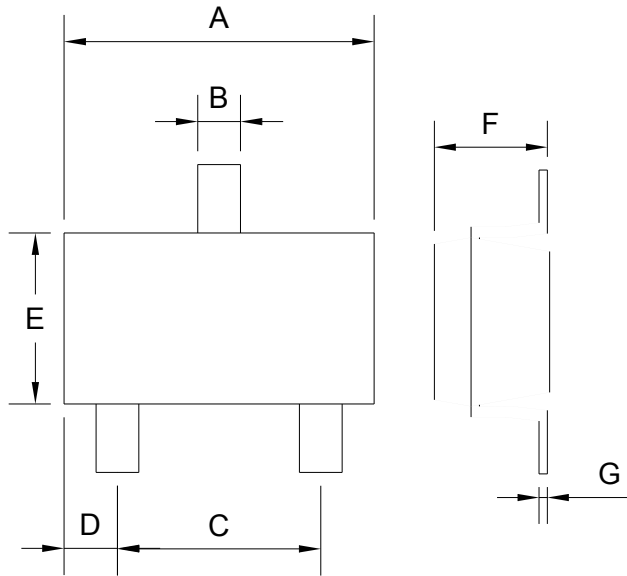

| SOT-23 DIMENSION | | | | |
|------------------|-------------|------|--------|-------|
| DIM | MILLIMETERS | | INCHES | |
| | MIN | MAX | MIN | MAX |
| A | 2.88 | 2.91 | 0.113 | 0.115 |
| B | 0.39 | 0.42 | 0.015 | 0.017 |
| C | 1.78 | 2.03 | 0.070 | 0.080 |
| D | 0.51 | 0.61 | 0.020 | 0.024 |
| E | 1.59 | 1.66 | 0.063 | 0.065 |
| F | 1.04 | 1.08 | 0.041 | 0.043 |
| G | 0.07 | 0.09 | 0.003 | 0.004 |